

1

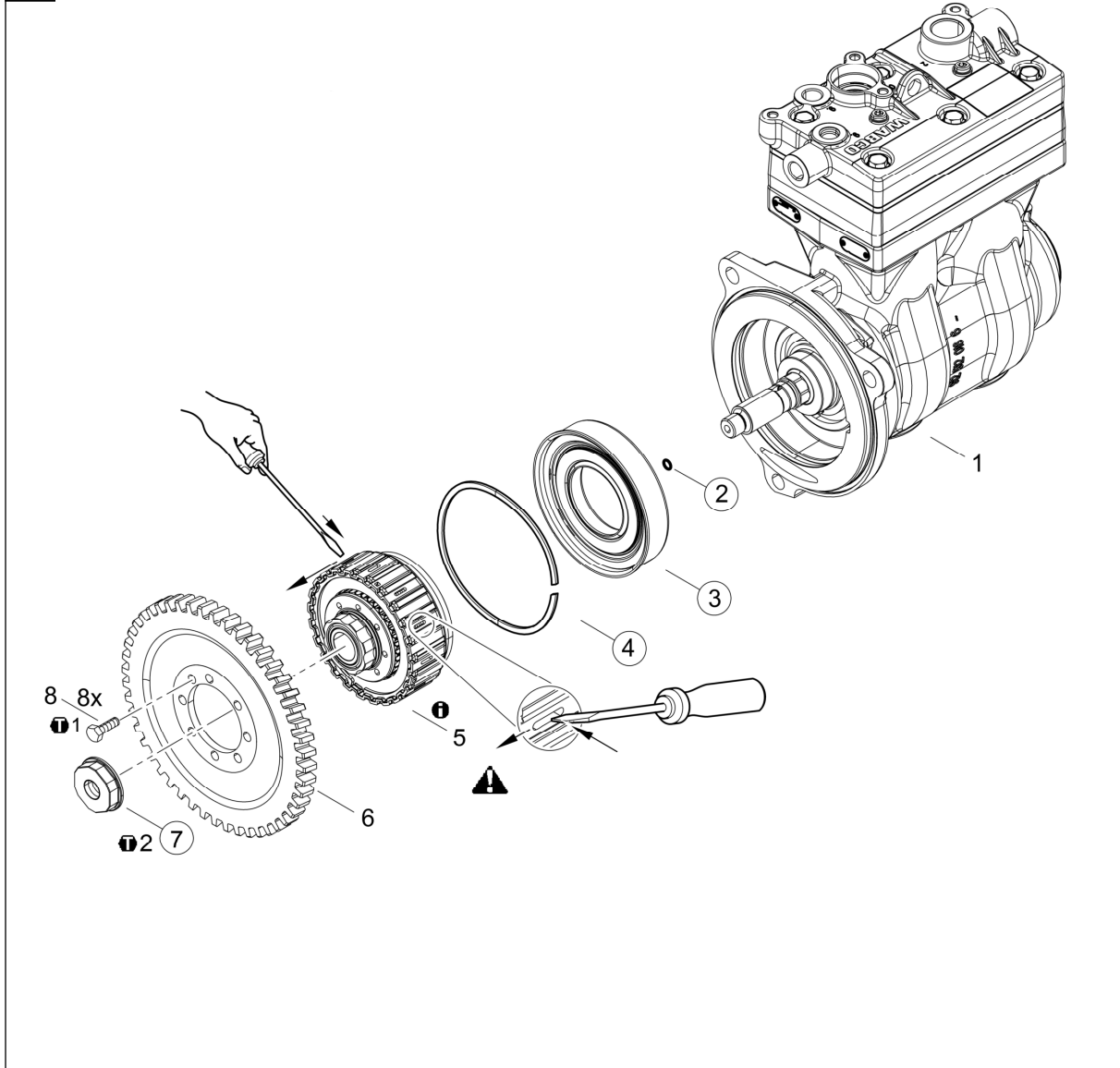

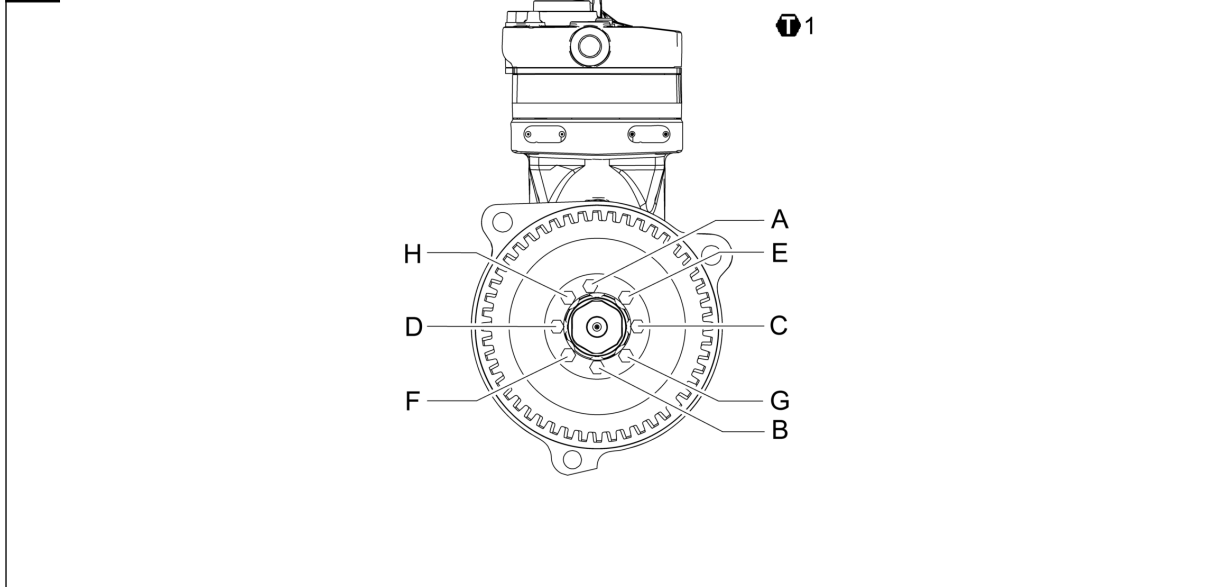



- 912 512 022 0
- 912 512 028 0
- 912 512 030 0
- 912 512 032 0
- 912 512 033 0
- 912 514 007 0
- 912 514 008 0
- 912 514 010 0
- 912 514 013 0
- 912 542 006 0
- 912 542 008 0
- 912 542 011 0
- 912 551 005 0
- 912 551 007 0
- 912 551 010 0





2



CS









## Signální slova a symboly

-  **DANGER** NEBEZPEČÍ Bezprostředně hrozící nebezpečí: těžká újma na zdraví nebo smrt
-  **WARNING** POZOR Možná nebezpečná situace: jako následek lehká nebo středně těžká újma na zdraví nebo poškození majetku
-  **CAUTION** VÝSTRAHA Možná nebezpečná situace: jako následek těžká újma na zdraví nebo smrt
-  Díly, které mají číslo pozice v kroužku, jsou obsažené v opravárenské sadě.

-  Instrukce / informace ke správnému provedení opravy
-  Opravárenskou sadu je možné použít pro přístroje uvedené v tabulce.
-  Prvek utáhněte uvedeným točivým momentem příp. pomocí kontroly úhlu natočení.
-  Úhel pootočení pro dotažení:





## Všeobecné pokyny k opravám





1. Opravárenské práce na přístrojích systému, který má vliv na bezpečnost vozidla, smí provádět pouze kvalifikovaný personál odborné servisní dílny.
3. Dodržujte předpisy BOZP podniku a národní předpisy.
5. S opravou začněte teprve tehdy, až všechny informace nutné pro opravu přečtete a porozumíte jim. Další potřebné dokumenty: zkušební postup, list náhradních dílů, všeobecné pokyny pro opravu a kontrolu (815 150 109 3) naleznete na internetových stránkách: [www.wabco-auto.com](http://www.wabco-auto.com), když v databázi INFORM zadáte produktové číslo přístroje nebo číslo dokumentu.
2. Postupujte bezpodmínečně podle pokynů a instrukcí výrobce vozidla.
4. Používejte výhradně náhradní díly od firmy WABCO nebo díly schválené výrobcem vozidla.
6. Na adekvátním zařízení přezkoušejte – podle zkušebního postupu – každý opravený přístroj na funkčnost a těsnost.

Obrázek	Symbol	Pozice	Pracovní operace	Postup montáže	Utahovací moment:	Úhel pootočení pro dotažení:	Poznámky
	 1	8		A, B, C, D, E, F, G, H	12 ± 2 Nm		
	 2	7	1		100 Nm		
			2				Uvolněte matici
			3		45 ± 5 Nm		
			4			95° ± 5°	(190 - 250 Nm)
		5					Pro demontáž a montáž potřebujete zvláštní nářadí.
		5					Neotevírat! Předepnutá pružina!

de

## Signalwörter & Symbole





-  **DANGER** GEFAHR Unmittelbar drohende Gefährdung: Schwere Personenschäden oder Tod
-  **WARNING** VORSICHT Mögliche Gefahrensituation: Leichte oder mittelschwere Personenschäden oder Sachschäden als Folge
-  **CAUTION** WARNUNG Mögliche Gefahrensituation: Tod oder schwere Personenschäden als Folge
-  Teile mit Kreis um die Positionsnummer sind im Reparatursatz enthalten.

-  Anweisung / Information für eine korrekte Reparatur
-  Der Reparatursatz kann für Geräte entsprechend Tabelle verwendet werden.
-  Element mit angegebenen Drehmoment bzw. Drehwinkel anziehen.
-  Weiterdrehwinkel:

de





## Allgemeine Reparaturhinweise





1. Reparaturarbeiten an Geräten eines Fahrzeug-Sicherheitssystems darf nur qualifiziertes Personal einer Fachwerkstatt durchführen.
2. Leisten Sie den Vorgaben und Anweisungen des Fahrzeugherstellers unbedingt Folge.
3. Halten Sie Unfallverhütungsvorschriften des Betriebes sowie nationale Vorschriften ein.
4. Verwenden Sie ausschließlich von WABCO oder vom Fahrzeughersteller freigegebene Ersatzteile.
5. Beginnen Sie die Reparatur erst dann, wenn Sie alle Informationen, die für die Reparatur notwendig sind, gelesen und verstanden haben. Zusätzlich benötigte Dokumente: Prüfanweisung, Ersatzteilblatt, Allgemeine Reparatur- und Prüfhinweise (815 020 109 3) zu finden auf [www.wabco-auto.com](http://www.wabco-auto.com) mittels Eingabe der Produktnummer des Gerätes bzw. Druckschriftennummer in INFORM.
6. Prüfen Sie jedes reparierte Gerät – gemäß Prüfanweisung – an einer adäquaten Einrichtung auf Funktionstüchtigkeit und Dichtigkeit.

Bild	Symbol	Position	Arbeitsschritt	Montage Reihenfolge	Anzugsdrehmoment:	Weiterdrehwinkel:	Bemerkungen
<b>1+2</b>	 1	8		A, B, C, D, E, F, G, H	12 ± 2 Nm		
<b>1</b>	 2	7	1		100 Nm		
			2				Mutter lösen
			3		45 ± 5 Nm		
			4			95° ± 5°	(190 - 250 Nm)
<b>1</b>		5					Für die Demontage und Montage ist ein Sonderwerkzeug erforderlich.
<b>1</b>		5					Nicht öffnen! Federvorspannung!

en

## Symbols & Signal Words





-  **DANGER** Imminent hazard situation: serious personal injury or death as a result
-  **WARNING** Possible hazard situation: minor or moderate personal injury or material loss as a result
-  **CAUTION** Possible hazard situation: serious personal injury or death as a result
-  Parts having item numbers with circles are included in the kit.

-  Instruction / Information for a correct repair
-  The kit can be used for devices according table.
-  Tighten element with specified torque or angle of rotation.
-  Rotation angle:

## General Repair Hints

1. Only qualified personnel of a specialist workshop are authorized to perform repair work on a vehicle's security system.
2. Absolutely follow specifications and instructions of vehicle manufacturer.
3. Keep to company's relevant accident prevention regulations and national regulations.
4. Use only spare parts released by WABCO or vehicle manufacturer.
5. Always start repair work only when you have read and understood all information required for repair. Documents additionally needed: Test Instruction, Spare Parts List, General Repair and Test Hints (815 010 109 3) to be found on [www.wabco-auto.com](http://www.wabco-auto.com) by entering product number of the device or the publication number in INFORM.
6. Check each repaired equipment for functional efficiency and tightness on an adequate facility according to the test instruction.

en

Picture	Symbol	Item	Procedure	Sequence of assembly	Torque:	Rotation angle:	Comments
<b>1+2</b>	 1	8		A, B, C, D, E, F, G, H	12 ± 2 Nm		
<b>1</b>	 2	7	1		100 Nm		
			2				Loose nut
			3		45 ± 5 Nm		
			4			95° ± 5°	(190 - 250 Nm)
<b>1</b>		5					A special tool is required for disassembly and assembly
<b>1</b>		5					Do not open! Spring load!

es

## Símbolos & Palabras de aviso

 **DANGER** PELIGRO Situación de peligro inminente: Pueden ocasionarse daños personales graves o incluso mortales

 **WARNING** CUIDADO Posible situación de peligro: Pueden ocasionarse daños personales leves o moderados o pérdidas materiales

 **CAUTION** ADVERTENCIA Posible situación de peligro: Pueden ocasionarse daños personales graves o incluso mortales

 Los componentes incluidos en el kit son los números que aparecen con círculo.

 Instrucciones/Información para una correcta reparación





 El kit puede ser utilizado en los equipos que aparecen en la tabla.

 Apretar el elemento con el par de apriete o ángulo de giro indicado.

 Ángulo de rotación:





## Consejos generales de reparación





- Sólo el personal cualificado de un taller especializado está autorizado para realizar las tareas de reparación en los sistemas de seguridad de los vehículos.
- Atenerse exactamente a las indicaciones e instrucciones del fabricante del vehículo.
- Siga las regulaciones y normas acerca de prevención de riesgos laborales de su empresa y de su país.
- Utilice piezas de repuesto suministradas por WABCO o el fabricante del vehículo.
- Comience la reparación sólo cuando haya leído y comprendido las instrucciones de reparación. Documentos adicionales necesarios: Instrucciones de comprobación, listas de despiece, consejos generales de comprobación y reparación (815 040 109 3), los cuales pueden encontrarse en [www.wabco-auto.com](http://www.wabco-auto.com), introduciendo la referencia del aparato o la referencia de la publicación en la aplicación INFORM.
- Compruebe la eficacia de funcionamiento y de ajuste de cada equipo reparado en unas instalaciones adecuadas según las instrucciones de comprobación.

Dibujo	Símbolo	Posición	Procedimiento	Montaje sucesión	Par de apriete:	Ángulo de rotación:	Observaciones
<b>1+2</b>	 1	8		A, B, C, D, E, F, G, H	12 ± 2 Nm		
<b>1</b>	 2	7	1		100 Nm		
			2				Aflojar tuerca
			3		45 ± 5 Nm		
			4			95° ± 5°	(190 - 250 Nm)
<b>1</b>		5					Para el desmontaje y el montaje se requiere una herramienta especial.
<b>1</b>		5					¡No abrir! Resorte comprimido!

fr









## Symboles & Significations

-  **DANGER** DANGER Situation de danger imminent : Danger de mort ou de dommage corporel sérieux.
-  **WARNING** ATTENTION Situation de danger probable : Risque de dommage corporel mineur ou modéré ou perte de matériel.
-  **CAUTION** AVERTISSEMENT Situation de danger de danger probable : Danger de mort ou de dommages corporel sérieux
-  Les composants avec repères entourés sont inclus dans le kit.

-  Instruction/Information pour une réparation correcte
-  Le kit peut être utilisé pour les appareils indiqués sur le Feuille.
-  Serrer l'élément avec le couple et la position angulaire indiqués.
-  Angle de rotation:





## Conseils généraux de réparation





1. Uniquement le personnel qualifié d'un atelier agréé WABCO est autorisé à effectuer la réparation sur les systèmes de sécurité d'un véhicule.
3. Veillez aux règlements de prévention des accidents indiqués par votre société et aux règlements nationaux.
5. Commencez toujours le travail de réparation seulement après avoir lu et compris toutes les informations indiquées pour la réparation. Documentation complémentaire nécessaire : Instruction d'essai, liste des pièces détachées, instructions de réparation et conseils d'essai (815 030 109 3) en tapant la référence du produit ou le numéro de la publication dans INFORM sur internet : [www.wabco-auto.com](http://www.wabco-auto.com)
2. Respecter toujours les prescriptions et instructions du constructeur du véhicule.
4. Employez seulement les pièces de rechange WABCO ou du constructeur du véhicule.
6. Examinez chaque appareil réparé pour s'assurer de l'efficacité fonctionnelle et de l'étanchéité selon l'instruction d'essai.

Image	Symbole	Position	Procédure	Les montages ordre	Couple de serrage:	Angle de rotation:	Remarques
	 1	8		A, B, C, D, E, F, G, H	12 ± 2 Nm		
	 2	7	1		100 Nm		
			2				écrou desserré
			3		45 ± 5 Nm		
			4			95° ± 5°	(190 - 250 Nm)
		5					Un outil spécial est requis pour le démontage et le montage.
		5					Ne pas ouvrir! Ressort comprimé!

hr

## Simboli & Značenja





-  **DANGER** OPREZ Neposredna rizična situacija: moguće ozbiljno ozljeđivanje ili smrt
-  **WARNING** OPASNOST neposredna rizična situacija: moguće manje ozljeđivanje materijalna šteta
-  **CAUTION** UPOZORENJE Neposredna rizična situacija: moguće ozbiljno ozljeđivanje ili smrt
-  Dijelovi uređaja čiji su brojevi zaokruženi nalaze se u kompletu..

-  Informacija o ispravnom popravku.
-  Set može biti korišten za uređaje prema tabeli.
-  Zategnite element primjenom navedenog zakretnog momenta ili zakretnog kuta.
-  Kut zakretanja:

hr





## Opće upute o popravcima





1. Samo kvalificirane osobe istručnjaci smiju popravljati sigurnosne sustave na vozilu.
2. U potpunosti slijedi specifikacije i upute proizvođača vozila.
3. Provodi tvrtkine sigurnosne propise kao i nacionalne propise o sigurnosti
4. Koristi rezervne dijelove proizvedene od WABCA ili proizvođača vozila..
5. Popravak počni tek nakon što pročitaš i shvatiš upute o popravku. Potrebni dokumenti: Instrukcije o testiranju, Lista rezervnih dijelova, Opće natuknice o popravku i testiranju (815 010 109 3) mogu se naći na [www.wabco-auto.com](http://www.wabco-auto.com) nakon upisa kataložskog broja proizvoda ili publikacije u INFORM-u.
6. Provjeri svaki popravljani uređaj kako radi i da li je zategnuto sve kako treba prema odgovarajućim uputama o testiranju proizvoda.

Slika	Simbol	Pojednost	Postupak	Redoslijed ugradnje	Zakretni moment:	Kut zakretanja:	Komentar
<b>1+2</b>	 1	8		A, B, C, D, E, F, G, H	12 ± 2 Nm		
<b>1</b>	 2	7	1		100 Nm		
			2				Otpusti maticu
			3		45 ± 5 Nm		
			4			95° ± 5°	(190 - 250 Nm)
<b>1</b>		5					Za demontažu i montažu treba poseban alat.
<b>1</b>		5					Ne otvaraj! Opruga pod opterećenjem!

it

## Simboli e Segnali





-  **DANGER** PERICOLO Imminente situazione di rischio: serie ferite personali fino anche alle morte
-  **WARNING** PRUDENZA Possibili situazioni di pericolo: possibili lievi ferite o perdita di materiale
-  **CAUTION** AVVERTENZA Possibili situazioni di pericolo: serie ferite personali fino anche alle morte
-  I componenti indicati con un numero cerchiato, sono inclusi nel kit.

-  Istruzioni/Informazioni per un'accurata riparazione
-  Il kit può essere usato per gli articoli secondo la tabella.
-  Serrare l'elemento con la coppia/angolo di rotazione indicati.
-  Angolo di rotazione:

## Suggerimenti per la riparazione





1. Soltanto il personale qualificato delle officine specializzate è autorizzato ad effettuare le riparazioni sui sistemi di sicurezza dei veicoli.
2. E' assolutamente necessario seguire le istruzioni e le specifiche del costruttore del veicolo.
3. Attenersi alle norme nazionali e aziendali in merito alla prevenzione degli infortuni.
4. Usare solo ricambi originali WABCO o del costruttore del veicolo.
5. Effettuare la riparazione solamente dopo aver letto e capito tutte le informazioni richieste per la riparazione. Ulteriori informazioni necessarie: istruzioni di collaudo, catalogo dei ricambi, cenni generali sulla riparazione e test (815 050 109 3) possono essere trovati sul sito [www.wabco-auto.com](http://www.wabco-auto.com) alla voce INFORM entrando per codice dell'apparecchio o per numero della pubblicazione.
6. Controllare la funzionalità e l'efficienza di ogni apparecchiatura riparata secondo le istruzioni riportate nel manuale di collaudo.





it

Figura	Simbolo	Particolare	Fase di lavoro	Sequenza di montaggio	Coppia di serraggio:	Angolo di rotazione:	Note
<b>1+2</b>	 1	8		A, B, C, D, E, F, G, H	12 ± 2 Nm		
<b>1</b>	 2	7	1		100 Nm		
			2				Dado allentato
			3		45 ± 5 Nm		
			4			95° ± 5°	(190 - 250 Nm)
<b>1</b>		5					Per lo smontaggio e il montaggio è necessario un attrezzo speciale.
<b>1</b>		5					Non aprire! Molla compressa!

nl





## Symbolen & trefwoorden

-  **DANGER** RISICO Direct gevaarlijke situatie: ernstig lichamelijk letsel of dood als gevolg
-  **WARNING** VOORZICHTIG Mogelijk gevaarlijke situatie: licht of middelmatig lichamelijk letsel of verlies van materiaal als gevolg.
-  **CAUTION** WAARSCHUWING Mogelijk gevaarlijke situatie: ernstig lichamelijk letsel of dood als gevolg
-  Componenten met een omcirkeld itemnummer zitten in de reparatieset.

-  Instructie/informatie voor reparatie op de juiste wijze
-  De reparatieset kan voor de componenten volgens de tabel worden gebruikt..
-  Draai het element met het aangegeven aanhaalmoment resp. de aangegeven draaihoek aan.
-  Draaihoek:





## Algemene reparatieaanwijzingen

1. Alleen gekwalificeerd personeel van een gespecialiseerde werkplaats is bevoegd reparatiewerkzaamheden uit te voeren aan componenten van voertuig-veiligheidssystemen.
2. Volg de richtlijnen en aanwijzingen van de voertuigfabrikant onvoorwaardelijk op.
3. Houdt u ter voorkoming van ongevallen aan de voorschriften van zowel het bedrijf als de overheid.
4. Gebruik uitsluitend vervangingsdelen die door WABCO of de voertuigfabrikant zijn vrijgegeven.
5. Begin reparatiewerkzaamheden altijd pas nadat u alle benodigde informatie heeft gelezen en begrepen. Benodigde documenten: Testvoorschriften, onderdelenlijst, algemene reparatie- en testaanwijzingen (815 010 109 3), die u kan vinden op [www.wabco-auto.com](http://www.wabco-auto.com) door het productnummer of publicatienummer in te geven in INFORM
6. Controleer elk gerepareerd component - volgens de testinstructies - op een testbank of soortgelijke installatie op juiste afstelling, werking en dichtheid.

Afbeelding	Symbol	Positie	Procedure	Volgorde van montage	Aanhaalmoment:	Draaihoek:	Opmerking
<b>1+2</b>	 1	8		A, B, C, D, E, F, G, H	12 ± 2 Nm		
<b>1</b>	 2	7	1		100 Nm		
			2				Moer losmaken
			3		45 ± 5 Nm		
			4			95° ± 5°	(190 - 250 Nm)
<b>1</b>		5					Voor demontage en montage is een speciaal gereedschap nodig.
<b>1</b>		5					Niet openen! Veer onder spanning!

pl

## Hasła ostrzegawcze i symbole

-  **DANGER** NIEBEZPIECZEŃSTWO Bezpośrednie zagrożenie ciężkimi obrażeniami bądź śmiercią.
-  **WARNING** UWAGA! Niebezpieczeństwo grożące lekkimi bądź średnimi obrażeniami.
-  **CAUTION** OSTRZEŻENIE Niebezpieczeństwo grożące śmiercią bądź ciężkimi obrażeniami.
-  Części oznaczone kółkiem wokół numeru pozycji należą do zestawu naprawczego.

 Wskazówki / Informacje dotyczące poprawnej naprawy.





 Zestaw naprawczy może być używany do urządzeń według tabeli.

 Dokręcić element podanym momentem obrotowym.

 Kąt obrotu:





## Ogólne porady naprawcze

1. Prace naprawcze w obrębie urządzeń układu bezpieczeństwa pojazdu mogą być wykonane jedynie przez wykwalifikowany personel specjalistycznego warsztatu.
3. Należy przestrzegać zakładowych i krajowych przepisów BHP.
5. Naprawę należy rozpocząć dopiero wówczas, gdy wszystkie potrzebne do niej informacje zostaną przeczytane i zrozumiane. Dokumenty potrzebne dodatkowo: instrukcja kontrolna, tabela części zamiennych, ogólne wskazówki dotyczące naprawy i kontroli (815 020 109 3) znajdują Państwo na stronie internetowej [www.wabco-auto.com](http://www.wabco-auto.com), podając numer urządzenia bądź numer publikacji w bazie INFORM.
2. Należy koniecznie postępować według wytycznych i wskazówek producenta pojazdu.
4. Należy używać wyłącznie części zamiennych dopuszczonych przez firmę WABCO bądź przez producenta pojazdu.
6. Na odpowiednim urządzeniu należy sprawdzić każde naprawiane urządzenie - zgodnie z instrukcją kontrolną - pod kątem sprawności działania i szczelności.

Obraz	Symbol	Pozycja	Czynność	Kolejność montażu	Moment dokręcania:	Kąt obrotu:	Komentarz
<b>1+2</b>	 1	8		A, B, C, D, E, F, G, H	12 ± 2 Nm		
<b>1</b>	 2	7	1		100 Nm		
			2				Luźna nakrętka
			3		45 ± 5 Nm		
			4			95° ± 5°	(190 - 250 Nm)
<b>1</b>		5					Do demontażu i montażu wymagane jest specjalne narzędzie.
<b>1</b>		5					Nie otwierać! Sprężyna!

ru

## Знаки & символы

-  **DANGER** ОПАСНО Прямая угроза аварийной ситуации: влечет за собой смерть или тяжелые повреждения
-  **WARNING** ОСТОРОЖНО Опасная ситуация: последствием являются легкие повреждения или повреждения средней тяжести, а также материальный ущерб
-  **CAUTION** ПРЕДУПРЕЖДЕНИЕ Опасная ситуация: влечет за собой смерть или тяжелые повреждения
-  Номера частей, обведенные кружком, Вы найдете в ремкомплекте.

 Указание/информация для проведения надлежащего ремонта

 Ремкомплект может быть использован для приборов соответственно таблице.

 Затянуть элемент с заданным моментом затяжки или на заданный угол поворота.

 Угол вращения:



ru





## Общие указания по ремонту





1. Провождение ремонта приборов данной системы должно производиться только квалифицированным персоналом в специализированной мастерской.
2. Следуйте предписаниям и инструкциям изготовителя транспортного средства.
3. Соблюдайте предписания предприятия по технике безопасности, а также национальные нормы.
4. Используйте только запчасти, допущенные к использованию компанией Wabco или производителем транспортного средства.
5. Проводите ремонт только после того, как вы прочитали и поняли все информации, необходимые для данного процесса. Дополнительные документы: инструкция по тестированию, список запасных частей, общие инструкции по ремонту и проведению испытаний (815 080 109 3) Вы найдете на [www.wabco-auto.com](http://www.wabco-auto.com). Для этого необходимо задать номер нужного прибора или номер брошюры в INFORM.
6. Проконтролируйте каждый отремонтированный прибор- согласно инструкции по тестированию- на работоспособность и герметичность с помощью соответствующего оборудования.

Изображение	Символ	Позиция	Порядок действия	Порядок действий при монтаже.	Момент сопротивления:	Угол вращения:	Замечания
<b>1+2</b>	 1	8		A, B, C, D, E, F, G, H	12 ± 2 Nm		
<b>1</b>	 2	7	1		100 Nm		
			2				Незатянутая гайка
			3		45 ± 5 Nm		
			4			95° ± 5°	(190 - 250 Nm)
<b>1</b>		5					Для разборки и сборки необходим специальный инструмент.
<b>1</b>		5					Не открывать! Натянутая пружина!

sv

## Signalord & symboler





-  **DANGER** FARA Omedelbar risk: svåra personskador eller dödsfall
-  **WARNING** VARNING Möjlig risk: Lätta eller medelsvåra personskador eller materiella skador
-  **CAUTION** VARNING Möjlig risksituation: Dödsfall eller svåra personskador
-  Delar med inringat positionsnummer ingår i reparationssetsen.

-  Anvisningar/information för korrekt reparation
-  Reparationssetsen kan användas för apparater enligt tabellen.
-  Dra åt elementet med angivet vridmoment resp. angiven vridvinkel.
-  Åtdragningsvinkel:

## Allmänna reparationsanvisningar





1. Reparationsarbeten på enheter i fordonssäkerhetssystem får endast genomföras av kvalificerad personal på behörig verkstad.
2. Beakta alltid fordonstillverkarens specifikationer och anvisningar.
3. Följ alltid företagets föreskrifter för förebyggande av olycksfall samt gällande nationella föreskrifter.
4. Används endast reservdelar som är godkända av WABCO eller fordonstillverkaren.
5. Börja inte med reparationsarbetena förrän du har läst igenom och förstätt all nödvändig information. Nödvändiga extradokument: Kontrollanvisning, reservdelsblad, allmän reparation och kontrollinformation (815 070 109 3). Du hittar dokumenten på [www.wabco-auto.com](http://www.wabco-auto.com) genom att mata in apparatens produktnummer eller dokumentnummer i INFORM.
6. Varje reparerad apparat ska kontrolleras på funktionsduglighet och tätthet på en lämplig anordning enligt kontrollanvisningen.





## SV

Bild	Symbol	Position	Arbetssteg	Ordningsföljd för montering	Åtdragningsmoment:	Åtdragningsvinkel:	Kommentar
<b>1+2</b>	 1	8		A, B, C, D, E, F, G, H	12 ± 2 Nm		
<b>1</b>	 2	7	1		100 Nm		
			2				Lossa muttern
			3		45 ± 5 Nm		
			4			95° ± 5°	(190 - 250 Nm)
<b>1</b>		5					För montering och demontering krävs ett specialverktyg.
<b>1</b>		5					Öppna ej! Fjäderförspänning!





## zh

### Symbols & Signal Words

-  **DANGER** 危险! 直接危险: 导致个人严重伤害或死亡
-  **WARNING** 小心! 可能危险: 导致较小或一般程度人员伤害或物品损失
-  **CAUTION** 警告! 可能危险: 导致个人严重伤害或死亡
-  修包中包含号码带有圆圈的零件。





-  用于正确维修的指导 and 信息。
-  根据表格所示, 修包可以用于相应的总成维修。
-  用给定的扭矩及转角上紧元件。
-  旋转角度:





1. 只有在专业维修店的有资质的人员被授权执行车辆安全系统的维修工作。
2. 完全遵循车辆制造商的规格和安装指导。
3. 遵循公司的相关事故预防条例和国家法规。
4. 仅使用于由威伯科公司或整车制造商发布的备件产品。
5. 当你已经阅读并理解维修所需要的所有信息后, 才能开始维修工作。此外需要的信息: 试验指导, 备件清单, 通用维修和试验提示 (815 010 109 3) 可以在 [www.wabco-auto.com](http://www.wabco-auto.com) 找到。只需在其上键入产品号码或INFORM中的出版物号码。
6. 根据试验要求在适当的设备上, 检测每个维修设备的功效和紧密性。

图片	符号	零件	程序	装配顺序	扭矩:	旋转角度:	注释
<b>1+2</b>	 1	8		A, B, C, D, E, F, G, H	12 ± 2 Nm		
<b>1</b>	 2	7	1		100 Nm		
			2				松动螺母
			3		45 ± 5 Nm		
			4			95° ± 5°	(190 - 250 Nm)
<b>1</b>		5					拆卸和安装需要使用一个特殊工具。
<b>1</b>		5					请勿拆开! 弹簧负载!

## tr

### Semboller&belirti sözleri





-  **DANGER** TEHLİKE Tehlikeli durum: ciddi personel yaralanması veya ölüm riski.
-  **WARNING** DİKKAT Tehlike riski: hafif personel yaralanması veya maddi zarar.
-  **CAUTION** UYARI Ciddi personel yaralanması veya ölüm riski.
-  Yuvarlak içinde numarası belirtilen parça numaraları kit içerisinde bulunur.

-  Talimat/ Doğru tamir için bilgi
-  Tabloda belirtilen parçalar için kit kullanılabilir.
-  Elemanı belirtilen sıkma torku ya da dönme açısı ile sıkın.
-  Dönüş açısı:

tr





## Genel tamir bilgisi





- Araçların güvenlik sistemlerinde tamir işlemlerini yalnızca eğitim almış konusunda uzman personeller gerçekleştirebilir.
- Araç üretici firma özellikler ve talimatlarına kesinlikle uyunuz.
- Şirket emniyet kuralları ve ulusal regülasyonlarına uyunuz.
- Sadece WABCO veya üretici firma tarafından yayınlanan yedek parçaları kullanın.
- Tamire, tamir işlemi için gerekli olan tüm bilgileri okuyup anladıktan sonra başlayınız. Ayrıca gerekli olan dokümanlar: Test talimatı, yedek parça sayfası, genel tamir ve test bilgileri (815 140 109 3). Tümünü linki altında, online ürün kataloğu INFORM'da cihaza ait ürün numarasını veya baskı numarasını girerek bulabilirsiniz.
- Tamir edilmiş her cihazı - test talimatına uygun şekilde - uygun bir donanımla işlevsellik ve sızdırmazlık konusunda kontrol edin.

Resim	Sembol	Parça	Prosedür	Montaj sırası	Tork:	Dönüş açısı:	Yorumlar
<b>1+2</b>	 1	8		A, B, C, D, E, F, G, H	12 ± 2 Nm		
<b>1</b>	 2	7	1		100 Nm		
			2				Vida somunu gevsetmek
			3		45 ± 5 Nm		
			4			95° ± 5°	(190 - 250 Nm)
<b>1</b>		5					Sökme işlemi ve montaj için özel bir el aleti gereklidir.
<b>1</b>		5					Açmayın! Yay yükü!

pt

## Símbolos e Significados





-  **DANGER** Perigo! Risco de acidente iminente: lesão corporal grave e/ou risco de morte.
-  **WARNING** Cuidado! Possível situação de acidente: ferimentos leves/moderados e/ou danos materiais.
-  **CAUTION** Atenção! Possível situação de acidente: lesão corporal grave e/ou risco de morte.
-  Componentes que estão marcados com um círculo compõem o jogo de reparo.

-  Instrução/Informação para uma correta reparação.
-  O jogo de reparo pode ser utilizado nos produtos relacionados na tabela.
-  Apertar o elemento com o binário ou o ângulo de rotação indicado.
-  Ângulo de rotação:

## Dicas Gerais para Reparação





- Por motivo de segurança, somente pessoas qualificadas devem efetuar reparação nos sistemas de freio do veículo.
- Siga sempre as recomendações/especificações do fabricante do veículo.
- Mantenha e siga as orientações de prevenção de acidentes vigentes e/ou impostas pelos órgãos competentes.
- Use somente peças de reposição aprovadas pela WABCO ou pelo fabricante do veículo.
- Somente inicie o trabalho de reparação após ler e entender todas as informações necessárias para realizar uma reparação. Documentos adicionais necessários: instrução de teste, lista de peças sobressalentes, dicas gerais de testes e reparação (815 130 109 3) podem ser encontrados no site [www.wabco-auto.com](http://www.wabco-auto.com) ao inserir o número do produto.
- Verificar cada produto reparado conforme instruções de teste, utilizando os equipamentos necessários e local adequado.





pt

Figura	Símbolo	Item	Procedimento	Sequência de montagem	Torque:	Ângulo de rotação:	Comentários
<b>1+2</b>		8		A, B, C, D, E, F, G, H	12 ± 2 Nm		
<b>1</b>		7	1		100 Nm		
			2				Porca solta
			3		45 ± 5 Nm		
			4			95° ± 5°	(190 - 250 Nm)
<b>1</b>		5					Para montar e desmontar é necessária uma ferramenta especial.
<b>1</b>		5					Não abra! Mola forte!

ko

### Symbols & Signal Words

-  **DANGER** 급박한 위험 상황: 심각한 상해 또는 사망에 이르게 할 수 있습니다.
-  **WARNING** 잠재적 위험 상황: 경미하거나 완화된 부상 또는 물질적 손실을 입을 수 있습니다.
-  **CAUTION** 잠재적 위험 상황: 심각한 상해 또는 사망에 이르게 할 수 있습니다.
-  본 키트에는 원숫자로 표기된 제품들만 포함되어 있습니다.

-  올바른 수리를 위한 설명 / 정보
-  표를 참조하여 제품에 대한 키트를 사용할 수 있습니다.
-  제시된 토크 및 회전각으로 요소를 조이십시오.
-  회전 각도:

1. 자격이 있는 전문 정비사만이 차량의 안전 시스템을 수리할 수 있습니다.
3. 회사의 사고예방 규제와 국내 법적 규제를 지키십시오.
5. 항상 수리에 필요한 모든 정보를 읽고 이해했을 때만 작업을 시작하십시오. 추가적으로 필요한 간행물: 검사지침, 예비부품 리스트, 일반적인 수리 및 검사 참고사항 (815 010 109 3)은 와브코 홈페이지 [www.wabco-auto.com](http://www.wabco-auto.com)의 INFORM으로 들어가셔서 제품번호 또는 간행물 번호를 조회하여 찾으실 수 있습니다.
2. 꼭 차량제조사의 사양과 지침서를 따르십시오.
4. 와브코 또는 차량 제조사로부터 제공된 예비부품만을 사용하십시오.
6. 기능적 효율과 견고함을 위해 검사지침에 따라 각 수리장비들을 적절한 설비위에서 체크해 보시기 바랍니다.

그림	기호	품목	절차	조립 순서	토크:	회전 각도:	주석
<b>1+2</b>		8		A, B, C, D, E, F, G, H	12 ± 2 Nm		
<b>1</b>		7	1		100 Nm		
			2				너트를 풀어 주십시오.
			3		45 ± 5 Nm		
			4			95° ± 5°	(190 - 250 Nm)
<b>1</b>		5					분해 및 조립을 하기 위해서는 특정 장비가 요구됩니다.
<b>1</b>		5					열지 마십시오! 스프링의 위험이 있습니다!