

1

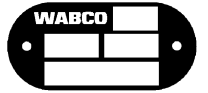

- 912 116 002 0
- 912 160 000 0
- 912 160 001 0
- 912 160 002 0
- 912 512 005 0
- 912 512 006 0
- 912 512 007 0
- 912 514 003 0
- 912 550 000 0
- 912 550 000 2
- 912 550 003 0
- 912 550 004 0
- 912 550 006 0
- 912 550 007 0
- 912 550 009 0
- 912 560 007 0
- 912 560 008 0
- 912 560 009 0
- 912 562 000 0

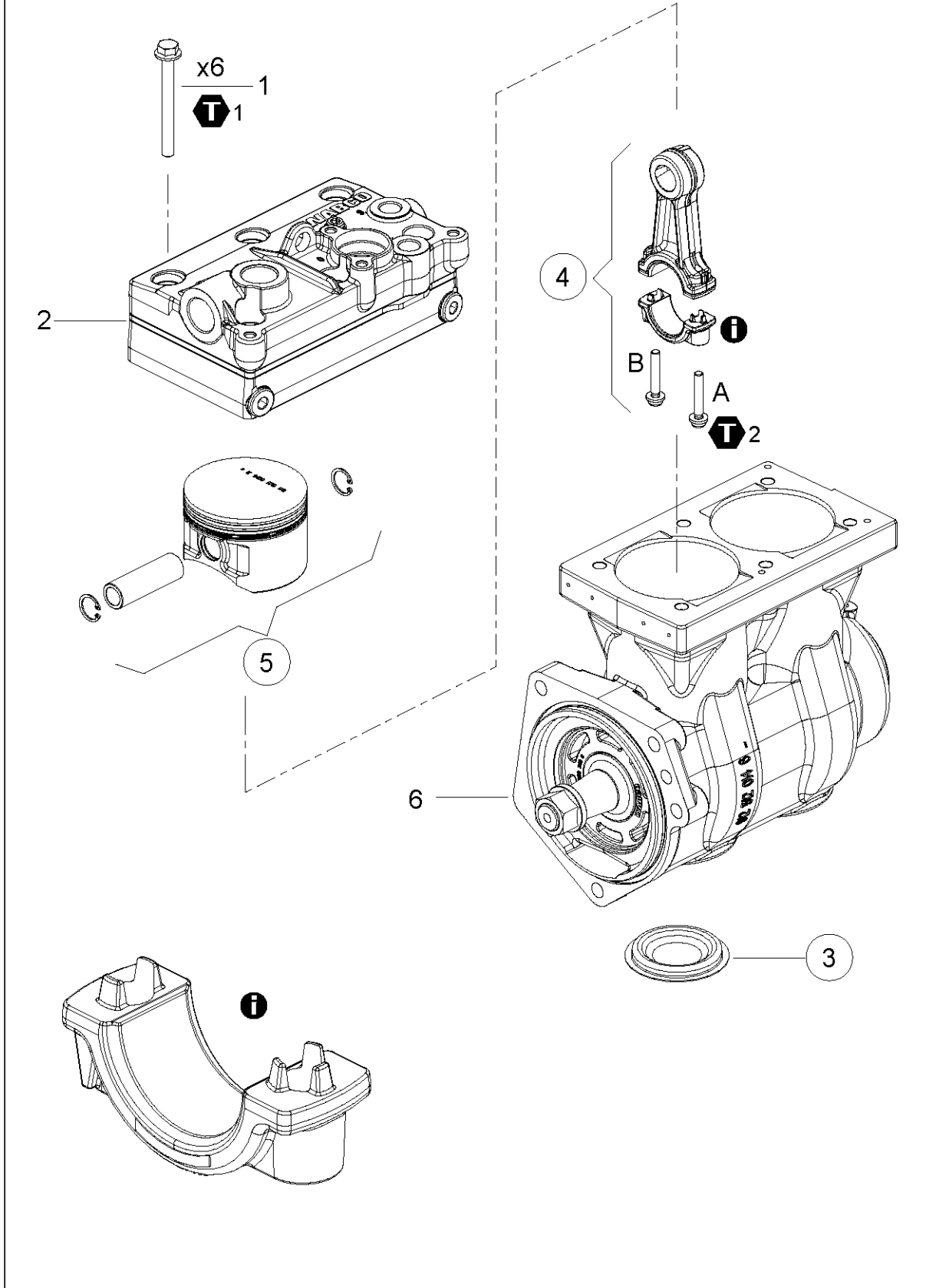
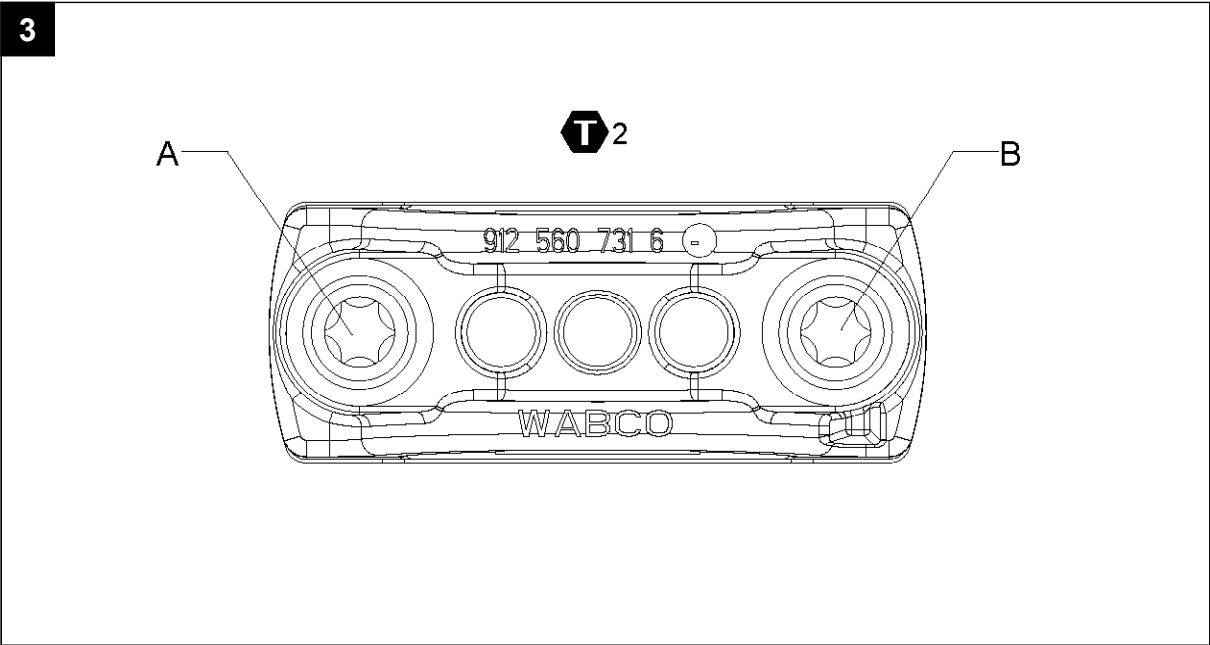
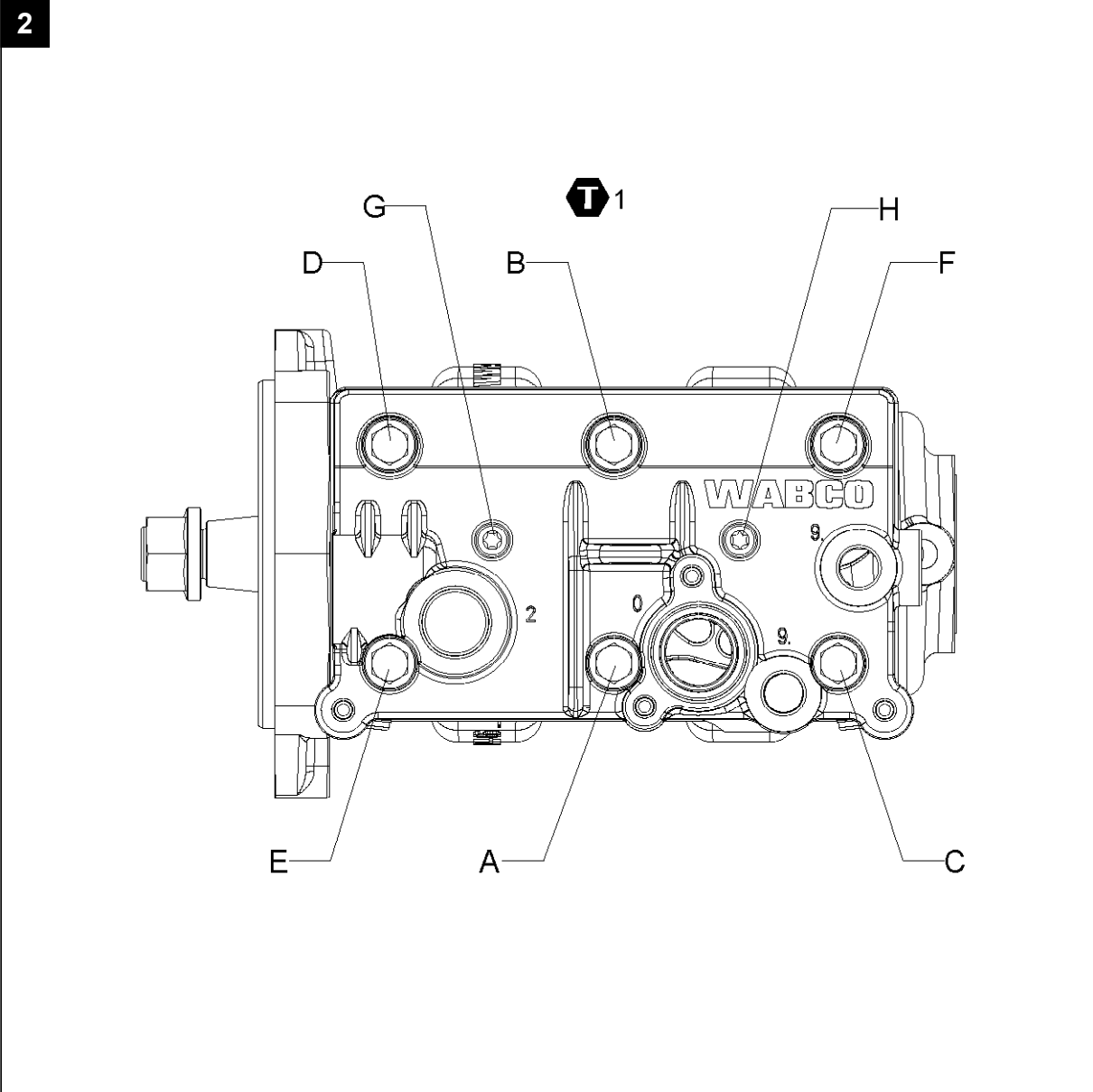

4

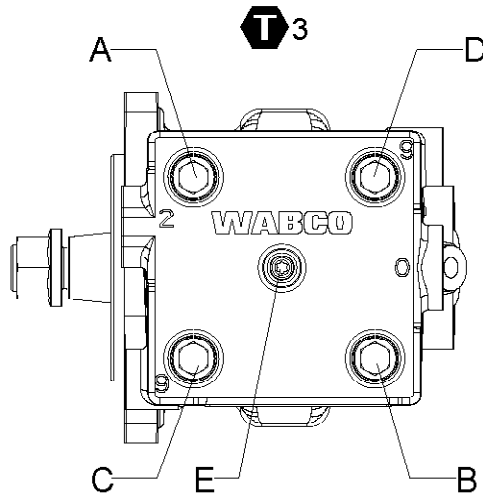



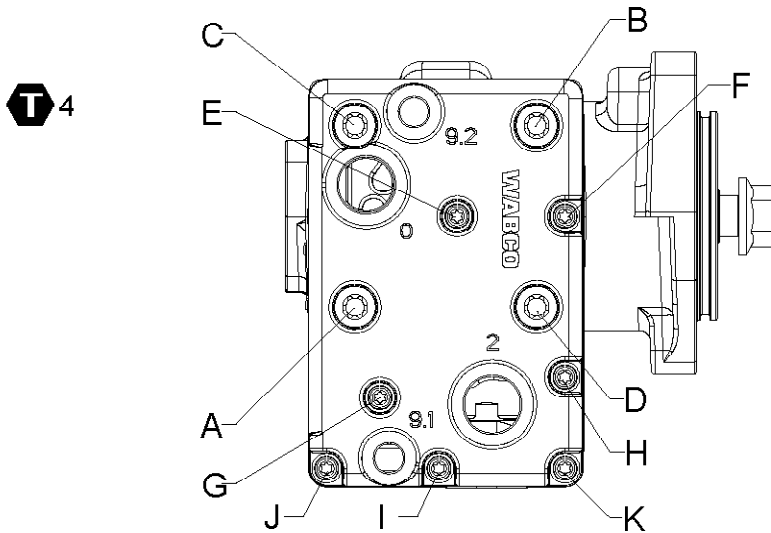

5

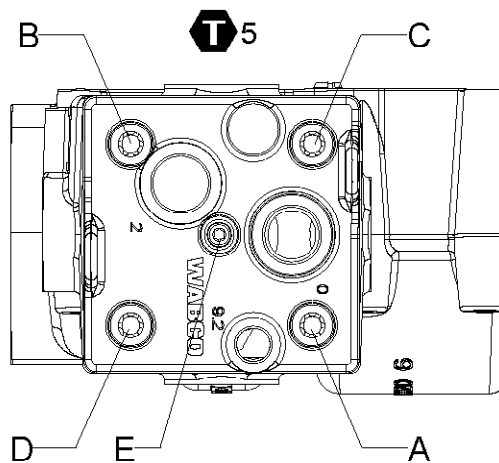



6



## Signalwörter & Symbole

-  **DANGER** GEFAHR Unmittelbar drohende Gefährdung: Schwere Personenschäden oder Tod
-  **WARNING** VORSICHT Mögliche Gefahrensituation: Leichte oder mittelschwere Personenschäden oder Sachschäden als Folge
-  **CAUTION** WARNUNG Mögliche Gefahrensituation: Tod oder schwere Personenschäden als Folge
-  Teile mit Kreis um die Positionsnummer sind im Reparatursatz enthalten.
-  Weiterdrehwinkel.

 Anweisung / Information für eine korrekte Reparatur

 Der Reparatursatz kann für Geräte entsprechend Tabelle verwendet werden.

 Element mit angegebenen Drehmoment bzw. Drehwinkel anziehen.

**NOTE** Anweisung / Information für eine korrekte Reparatur

## Allgemeine Reparaturhinweise

1. Reparaturarbeiten an Geräten eines Fahrzeug-Sicherheitssystems darf nur qualifiziertes Personal einer Fachwerkstatt durchführen.
3. Halten Sie Unfallverhütungsvorschriften des Betriebes sowie nationale Vorschriften ein.
5. Beginnen Sie die Reparatur erst dann, wenn Sie alle Informationen, die für die Reparatur notwendig sind, gelesen und verstanden haben. Zusätzlich benötigte Dokumente: Prüfanweisung, Ersatzteilblatt, Allgemeine Reparatur- und Prüfinweise (815 020 109 3) zu finden auf [www.wabco-auto.com](http://www.wabco-auto.com) mittels Eingabe der Produktnummer des Gerätes bzw. Druckschriftennummer in INFORM.
7. WABCO übernimmt keinerlei Gewährleistung für die Funktion oder Qualität eines reparierten Gerätes
2. Leisten Sie den Vorgaben und Anweisungen des Fahrzeugherstellers unbedingt Folge.
4. Verwenden Sie ausschließlich von WABCO oder vom Fahrzeughersteller freigegebene Ersatzteile.
6. Prüfen Sie jedes reparierte Gerät – gemäß Prüfanweisung – an einer adäquaten Einrichtung auf Funktionstüchtigkeit und Dichtigkeit.





de

## Montage Reihenfolge

Bild	Symbol	Arbeitsschritt	Reihenfolge:	Anzugsdrehmoment:	Weiterdrehwinkel:	Bemerkungen
<b>1+2</b>						für Geräte 912 512 005 0, 912 512 006 0, 912 512 007 0, 912 514 003 0, 912 550 000 0, 912 550 000 2, 912 550 002 0, 912 550 003 0, 912 550 004 0, 912 550 006 0, 912 550 007 0, 912 550 009 0, 912 560 007 0, 912 560 008 0, 912 560 009 0, 912 562 000 0
		1	A, B, C, D, E, F	M = 20 ± 2 Nm		Stellen Sie vor dem nächsten Arbeitsschritt sicher, dass alle Schrauben das richtige Anzugsmoment haben.
		2.1	A, B, C, D, E, F		90° +10° /-5°	
		2.2	A, B, C, D, E, F		90° +10° /-5°	
		3	G, H			Schraube lösen.180°
		4	G, H	M = 7 ± 2 Nm		
		5	G, H		180° + 10° /-5°	
<b>3</b>		1	A, B	M = 6 ± 0.6 Nm		
		2	A, B		70° + 15° /-5°	
<b>4</b>						für Geräte 912 160 002 0
		1	A, B, C, D	M = 20 ± 2 Nm		Stellen Sie vor dem nächsten Arbeitsschritt sicher, dass alle Schrauben das richtige Anzugsmoment haben.
		2	A, B, C, D		90° + 10° /-5°	
		3	E			Schraube lösen.180°
		4	E	M = 7 ± 2 Nm		
		5	E		90° + 10° /-5°	
<b>5</b>						für Geräte 912 160 000 0, 912 116 002 0
		1	A, B, C, D	M = 20 ± 2 Nm		Stellen Sie vor dem nächsten Arbeitsschritt sicher, dass alle Schrauben das richtige Anzugsmoment haben.
		2	A, B, C, D		90° + 10° /-5°	
		3	E, F, G, H, I, J, K			Schraube lösen.180°
		4	E, F, G, H, I, J, K	M = 7 ± 2 Nm		
		5	E, F, G, H, I, J, K		90° + 10° /-5°	
<b>6</b>						für Geräte 912 160 001 0
		1	A, B, C, D	M = 20 ± 2 Nm		Stellen Sie vor dem nächsten Arbeitsschritt sicher, dass alle Schrauben das richtige Anzugsmoment haben.
		2	A, B, C, D		90° + 10° /-5°	
		3	E			Schraube lösen.180°
		4	E	M = 10 ± 1 Nm		
		5	E		90° + 10° /-5°	
<b>1</b>						Einbaulage beachten.

en

## Symbols & Signal Words

-  **DANGER** Imminent hazard situation: serious personal injury or death as a result
-  **WARNING** Possible hazard situation: minor or moderate personal injury or material loss as a result
-  **CAUTION** Possible hazard situation: serious personal injury or death as a result
-  Parts having item numbers with circles are included in the kit.
-  Rotation angle.

 Instruction / Information for a correct repair

 The kit can be used for devices according table.

 Tighten element with specified torque or angle of rotation.





















**NOTE** Instruction / Information for a correct repair

## General Repair Hints

1. Only qualified personnel of a specialist workshop are authorized to perform repair work on a vehicle's security system.
2. Absolutely follow specifications and instructions of vehicle manufacturer.
3. Keep to company's relevant accident prevention regulations and national regulations.
4. Use only spare parts released by WABCO or vehicle manufacturer.
5. Always start repair work only when you have read and understood all information required for repair. Documents additionally needed: Test Instruction, Spare Parts List, General Repair and Test Hints (815 010 109 3) to be found on [www.wabco-auto.com](http://www.wabco-auto.com) by entering product number of the device or the publication number in INFORM.
6. Check each repaired equipment for functional efficiency and tightness on an adequate facility according to the test instruction.
7. WABCO does not accept any liability or responsibility for the quality or functionality of a repaired device





en



## Sequence of assembly

Picture	Symbol	Procedure	Sequence:	Torque:	Rotation angle:	Comments
<b>1+2</b>	 1					for devices 912 512 005 0, 912 512 006 0, 912 512 007 0, 912 514 003 0, 912 550 000 0, 912 550 000 2, 912 550 002 0, 912 550 003 0, 912 550 004 0, 912 550 006 0, 912 550 007 0, 912 550 009 0, 912 560 007 0, 912 560 008 0, 912 560 009 0, 912 562 000 0
		1	A, B, C, D, E, F	M = 20 ± 2 Nm		Ensure accurate torque at all screws before next step.
		2.1	A, B, C, D, E, F		90° +10° /-5°	
		2.2	A, B, C, D, E, F		90° +10° /-5°	
		3	G, H			Unbolt screw.180°
		4	G, H	M = 7 ± 2 Nm		
		5	G, H		180° + 10° /-5°	
<b>3</b>	 2	1	A, B	M = 6 ± 0.6 Nm		
		2	A, B		70° + 15° /-5°	
<b>4</b>	 3					for devices 912 160 002 0
		1	A, B, C, D	M = 20 ± 2 Nm		Ensure accurate torque at all screws before next step.
		2	A, B, C, D		90° + 10° /-5°	
		3	E			Unbolt screw.180°
		4	E	M = 7 ± 2 Nm		
		5	E		90° + 10° /-5°	
<b>5</b>	 4					for devices 912 160 000 0, 912 116 002 0
		1	A, B, C, D	M = 20 ± 2 Nm		Ensure accurate torque at all screws before next step.
		2	A, B, C, D		90° + 10° /-5°	
		3	E, F, G, H, I, J, K			Unbolt screw.180°
		4	E, F, G, H, I, J, K	M = 7 ± 2 Nm		
		5	E, F, G, H, I, J, K		90° + 10° /-5°	
<b>6</b>	 5					for devices 912 160 001 0
		1	A, B, C, D	M = 20 ± 2 Nm		Ensure accurate torque at all screws before next step.
		2	A, B, C, D		90° + 10° /-5°	
		3	E			Unbolt screw.180°
		4	E	M = 10 ± 1 Nm		
		5	E		90° + 10° /-5°	
<b>1</b>						Observe installation position.

hr

## Simboli & Značenja





















-  **DANGER** OPREZ Neposredna rizična situacija: moguće ozbiljno ozljeđivanje ili smrt
-  **WARNING** OPASNOST neposredna rizična situacija: moguće manje ozljeđivanje materijalna šteta
-  **CAUTION** UPOZORENJE Neposredna rizična situacija: moguće ozbiljno ozljeđivanje ili smrt
-  Dijelovi uređaja čiji su brojevi zaokruženi nalaze se u kompletu..
-  Kut zakretanja.

-  Informacija o ispravnom popravku.
-  Set može biti korišten za uređaje prema tabeli.
-  Zategnite element primjenom navedenog zakretnog momenta ili zakretnog kuta.
- NOTE** Informacija o ispravnom popravku.

## Opće upute o popravcima

1. Samo kvalificirane osobe istručnjaci smiju popravljati siguronosne sustave na vozilu.
2. U potpunosti slijedi specifikacije i upute proizvođača vozila.
3. Provodi tvrtkine siguronosne propise kao i nacionalne propise o sigurnosti
4. Koristi rezervne dijelove proizvedene od WABCA ili proizvođača vozila..
5. Popravak počni tek nakon što pročitaš i shvatiš upute o popravku. Potrebni dokumenti: Instrukcije o testiranju, Lista rezervnih dijelova, Opće natuknice o popravku i testiranju (815 010 109 3) mogu se naći na [www.wabco-auto.com](http://www.wabco-auto.com) nakon upisa kataložnog broja proizvoda ili publikacije u INFORM-u.
6. Provjeri svaki popravljani uređaj kako radi i da li je zategnuto sve kako treba prema odgovarajućim uputama o testiranju proizvoda.
7. WABCO ne preuzima odgovornost za rad i kvalitetu popravljenog uređaja.





## Redosljed ugradnje

Slika	Simbol	Postupak	Redosljed:	Zakretni moment:	Kut zakretanja:	Komentar
<b>1+2</b>						za uređaj 912 512 005 0, 912 512 006 0, 912 512 007 0, 912 514 003 0, 912 550 000 0, 912 550 000 2, 912 550 002 0, 912 550 003 0, 912 550 004 0, 912 550 006 0, 912 550 007 0, 912 550 009 0, 912 560 007 0, 912 560 008 0, 912 560 009 0, 912 562 000 0
		1	A, B, C, D, E, F	M = 20 ± 2 Nm		Provjeri da su vijci stegnuti ispravno odgovarajućom silom zatezanja prije slijedećeg koraka
		2.1	A, B, C, D, E, F		90° +10° /-5°	
		2.2	A, B, C, D, E, F		90° +10° /-5°	
		3	G, H			Otpusti vijak180°
		4	G, H	M = 7 ± 2 Nm		
		5	G, H		180° + 10° /-5°	
<b>3</b>		1	A, B	M = 6 ± 0.6 Nm		
		2	A, B		70° + 15° /-5°	
<b>4</b>						za uređaj 912 160 002 0
		1	A, B, C, D	M = 20 ± 2 Nm		Provjeri da su vijci stegnuti ispravno odgovarajućom silom zatezanja prije slijedećeg koraka
		2	A, B, C, D		90° + 10° /-5°	
		3	E			Otpusti vijak180°
		4	E	M = 7 ± 2 Nm		
		5	E		90° + 10° /-5°	
<b>5</b>						za uređaj 912 160 000 0, 912 116 002 0
		1	A, B, C, D	M = 20 ± 2 Nm		Provjeri da su vijci stegnuti ispravno odgovarajućom silom zatezanja prije slijedećeg koraka
		2	A, B, C, D		90° + 10° /-5°	
		3	E, F, G, H, I, J, K			Otpusti vijak180°
		4	E, F, G, H, I, J, K	M = 7 ± 2 Nm		
		5	E, F, G, H, I, J, K		90° + 10° /-5°	
<b>6</b>						za uređaj 912 160 001 0
		1	A, B, C, D	M = 20 ± 2 Nm		Provjeri da su vijci stegnuti ispravno odgovarajućom silom zatezanja prije slijedećeg koraka
		2	A, B, C, D		90° + 10° /-5°	
		3	E			Otpusti vijak180°
		4	E	M = 10 ± 1 Nm		
		5	E		90° + 10° /-5°	
<b>1</b>						Provjeri položaj ugradnje.





nl

## Symbolen & trefwoorden

-  **DANGER** RISICO Direct gevaarlijke situatie: ernstig lichamelijk letsel of dood als gevolg
-  **WARNING** VOORZICHTIG Mogelijk gevaarlijke situatie: licht of middelmatig lichamelijk letsel of verlies van materiaal als gevolg.
-  **CAUTION** WAARSCHUWING Mogelijk gevaarlijke situatie: ernstig lichamelijk letsel of dood als gevolg
-  Componenten met een omcirkeld itemnummer zitten in de reparatieset.
-  Draaihoek.

 Instructie/informatie voor reparatie op de juiste wijze

 De reparatieset kan voor de componenten volgens de tabel worden gebruikt..

 Draai het element met het aangegeven aanhaalmoment resp. de aangegeven draaihoek aan.





















**NOTE** Instructie/informatie voor reparatie op de juiste wijze

## Algemene reparatieaanwijzingen

1. Alleen gekwalificeerd personeel van een gespecialiseerde werkplaats is bevoegd reparatiewerkzaamheden uit te voeren aan componenten van voertuig-veiligheidssystemen.
2. Volg de richtlijnen en aanwijzingen van de voertuigfabrikant onvoorwaardelijk op.
3. Houdt u ter voorkoming van ongevallen aan de voorschriften van zowel het bedrijf als de overheid.
4. Gebruik uitsluitend vervangingsdelen die door WABCO of de voertuigfabrikant zijn vrijgegeven.
5. Begin reparatiewerkzaamheden altijd pas nadat u alle benodigde informatie heeft gelezen en begrepen. Benodigde documenten: Testvoorschriften, onderdelenlijst, algemene reparatie- en testaanwijzingen (815 010 109 3), die u kan vinden op [www.wabco-auto.com](http://www.wabco-auto.com) door het productnummer of publicatienummer in te geven in INFORM
6. Controleer elk gerepareerd component - volgens de testinstructies - op een testbank of soortgelijke installatie op juiste afstelling, werking en dichtheid.
7. WABCO aanvaardt geen aansprakelijkheid of verantwoordelijkheid voor het functioneren en de kwaliteit van een gerepareerd apparaat.





nl

## Volgorde van montage

Afbeelding	Symbol	Procedure	Volgorde:	Aanhaalmoment:	Draaihoek:	Opmerking
<b>1+2</b>						voor componenten 912 512 005 0, 912 512 006 0, 912 512 007 0, 912 514 003 0, 912 550 000 0, 912 550 000 2, 912 550 002 0, 912 550 003 0, 912 550 004 0, 912 550 006 0, 912 550 007 0, 912 550 009 0, 912 560 007 0, 912 560 008 0, 912 560 009 0, 912 562 000 0
		1	A, B, C, D, E, F	M = 20 ± 2 Nm		Controleer voor de volgende stap, dat alle schroeven goed zijn aangedraaid.
		2.1	A, B, C, D, E, F		90° + 10° /-5°	
		2.2	A, B, C, D, E, F		90° + 10° /-5°	
		3	G, H			Draai de schroef los.180°
		4	G, H	M = 7 ± 2 Nm		
		5	G, H		180° + 10° /-5°	
<b>3</b>		1	A, B	M = 6 ± 0.6 Nm		
		2	A, B		70° + 15° /-5°	
<b>4</b>						voor componenten 912 160 002 0
		1	A, B, C, D	M = 20 ± 2 Nm		Controleer voor de volgende stap, dat alle schroeven goed zijn aangedraaid.
		2	A, B, C, D		90° + 10° /-5°	
		3	E			Draai de schroef los.180°
		4	E	M = 7 ± 2 Nm		
		5	E		90° + 10° /-5°	
<b>5</b>						voor componenten 912 160 000 0, 912 116 002 0
		1	A, B, C, D	M = 20 ± 2 Nm		Controleer voor de volgende stap, dat alle schroeven goed zijn aangedraaid.
		2	A, B, C, D		90° + 10° /-5°	
		3	E, F, G, H, I, J, K			Draai de schroef los.180°
		4	E, F, G, H, I, J, K	M = 7 ± 2 Nm		
		5	E, F, G, H, I, J, K		90° + 10° /-5°	
<b>6</b>						voor componenten 912 160 001 0
		1	A, B, C, D	M = 20 ± 2 Nm		Controleer voor de volgende stap, dat alle schroeven goed zijn aangedraaid.
		2	A, B, C, D		90° + 10° /-5°	
		3	E			Draai de schroef los.180°
		4	E	M = 10 ± 1 Nm		
		5	E		90° + 10° /-5°	
<b>1</b>						Let op inbouwpositie.

ru

## Знаки & символы

-  **DANGER** ОПАСНО Прямая угроза аварийной ситуации: влечет за собой смерть или тяжелые повреждения
-  **WARNING** ОСТОРОЖНО Опасная ситуация: последствиями являются легкие повреждения или повреждения средней тяжести, а также материальный ущерб
-  **CAUTION** ПРЕДУПРЕЖДЕНИЕ Опасная ситуация: влечет за собой смерть или тяжелые повреждения
-  Номера частей, обведенные кружком, Вы найдете в ремкомплекте.
-  Угол вращения.

 Указание/информация для проведения надлежащего ремонта

 Ремкомплект может быть использован для приборов соответственно таблице.

 Затянуть элемент с заданным моментом затяжки или на заданный угол поворота.





















**NOTE** Указание/информация для проведения надлежащего ремонта

## Общие указания по ремонту





1. Проведение ремонта приборов данной системы должно производиться только квалифицированным персоналом в специализированной мастерской.
3. Соблюдайте предписания предприятия по технике безопасности, а также национальные нормы.
5. Проводите ремонт только после того, как вы прочитали и поняли все информации, необходимые для данного процесса. Дополнительные документы: инструкция по тестированию, список запасных частей, общие инструкции по ремонту и проведению испытаний (815 080 109 3) Вы найдете на [www.wabco-auto.com](http://www.wabco-auto.com). Для этого необходимо задать номер нужного прибора или номер брошюры в INFORM.
7. Компания WABCO не принимает на себя какую-либо ответственность за работу или качество отремонтированных устройств.
2. Следуйте предписаниям и инструкциям изготовителя транспортного средства.
4. Используйте только запчасти, допущенные к использованию компанией Wabco или производителем транспортного средства.
6. Проконтролируйте каждый отремонтированный прибор- согласно инструкции по тестированию- на работоспособность и герметичность с помощью соответствующего оборудования.



ru

## Порядок действий при монтаже.

Изображение	Символ	Порядок действия	Последовательность:	Момент сопротивления:	Угол вращения:	Замечания
<b>1+2</b>						для приборов 912 512 005 0, 912 512 006 0, 912 512 007 0, 912 514 003 0, 912 550 000 0, 912 550 000 2, 912 550 002 0, 912 550 003 0, 912 550 004 0, 912 550 006 0, 912 550 007 0, 912 550 009 0, 912 560 007 0, 912 560 008 0, 912 560 009 0, 912 562 000 0
		1	A, B, C, D, E, F	$M = 20 \pm 2 \text{ Nm}$		Перед следующим этапом работ убедитесь в том, что для всех винтов применен соответствующий момент затяжки.
		2.1	A, B, C, D, E, F		$90^\circ + 10^\circ / -5^\circ$	
		2.2	A, B, C, D, E, F		$90^\circ + 10^\circ / -5^\circ$	
		3	G, H			отвинтите болт. $180^\circ$
		4	G, H	$M = 7 \pm 2 \text{ Nm}$		
		5	G, H		$180^\circ + 10^\circ / -5^\circ$	
<b>3</b>						
		1	A, B	$M = 6 \pm 0.6 \text{ Nm}$		
		2	A, B		$70^\circ + 15^\circ / -5^\circ$	
<b>4</b>						для приборов 912 160 002 0
		1	A, B, C, D	$M = 20 \pm 2 \text{ Nm}$		Перед следующим этапом работ убедитесь в том, что для всех винтов применен соответствующий момент затяжки.
		2	A, B, C, D		$90^\circ + 10^\circ / -5^\circ$	
		3	E			отвинтите болт. $180^\circ$
		4	E	$M = 7 \pm 2 \text{ Nm}$		
		5	E		$90^\circ + 10^\circ / -5^\circ$	
<b>5</b>						для приборов 912 160 000 0, 912 116 002 0
		1	A, B, C, D	$M = 20 \pm 2 \text{ Nm}$		Перед следующим этапом работ убедитесь в том, что для всех винтов применен соответствующий момент затяжки.
		2	A, B, C, D		$90^\circ + 10^\circ / -5^\circ$	
		3	E, F, G, H, I, J, K			отвинтите болт. $180^\circ$
		4	E, F, G, H, I, J, K	$M = 7 \pm 2 \text{ Nm}$		
		5	E, F, G, H, I, J, K		$90^\circ + 10^\circ / -5^\circ$	
<b>6</b>						для приборов 912 160 001 0
		1	A, B, C, D	$M = 20 \pm 2 \text{ Nm}$		Перед следующим этапом работ убедитесь в том, что для всех винтов применен соответствующий момент затяжки.
		2	A, B, C, D		$90^\circ + 10^\circ / -5^\circ$	
		3	E			отвинтите болт. $180^\circ$
		4	E	$M = 10 \pm 1 \text{ Nm}$		
		5	E		$90^\circ + 10^\circ / -5^\circ$	
<b>1</b>						Обратите внимание на местоположение при монтаже.

**Signalord & symboler**

-  **DANGER** FARA Omedelbar risk: svåra personskador eller dödsfall
-  **WARNING** VARNING Möjlig risk: Lätta eller medelsvåra personskador eller materiella skador
-  **CAUTION** VARNING Möjlig risksituation: Dödsfall eller svåra personskador
-  Delar med inringat positionsnummer ingår i reparationssatsen.
-  Åtdragningsvinkel.





















-  Anvisningar/information för korrekt reparation
-  Reparationssatsen kan användas för apparater enligt tabellen.
-  Dra åt elementet med angivet vridmoment resp. angiven vridvinkel.
- NOTE** Anvisningar/information för korrekt reparation

**Allmänna reparationsanvisningar**

1. Reparationsarbeten på enheter i fordonssäkerhetssystem får endast genomföras av kvalificerad personal på behörig verkstad.
2. Beakta alltid fordonstillverkarens specifikationer och anvisningar.
3. Följ alltid företagets föreskrifter för förebyggande av olycksfall samt gällande nationella föreskrifter.
4. Används endast reservdelar som är godkända av WABCO eller fordonstillverkaren.
5. Börja inte med reparationsarbetena förrän du har läst igenom och förstått all nödvändig information. Nödvändiga extradokument: Kontrollanvisning, reservdelsblad, allmän reparation och kontrollinformation (815 070 109 3). Du hittar dokumenten på [www.wabco-auto.com](http://www.wabco-auto.com) genom att mata in apparatens produktnummer eller dokumentnummer i INFORM.
6. Varje reparerad apparat ska kontrolleras på funktionsduglighet och täthet på en lämplig anordning enligt kontrollanvisningen.
7. WABCO ansvarar inte för reparerade enheters funktion eller kvalitet.

SV

## Ordningsföljd för montering

Bild	Symbol	Arbetssteg	Ordningsföljd:	Åtdragningsmoment:	Åtdragningsvinkel:	Kommentar
<b>1+2</b>						för apparater 912 512 005 0, 912 512 006 0, 912 512 007 0, 912 514 003 0, 912 550 000 0, 912 550 000 2, 912 550 002 0, 912 550 003 0, 912 550 004 0, 912 550 006 0, 912 550 007 0, 912 550 009 0, 912 560 007 0, 912 560 008 0, 912 560 009 0, 912 562 000 0
		1	A, B, C, D, E, F	M = 20 ± 2 Nm		Kontrollera att alla skruvar har rätt åtdragningsmoment innan du går vidare till nästa arbetsmoment.
		2.1	A, B, C, D, E, F		90° + 10° /-5°	
		2.2	A, B, C, D, E, F		90° + 10° /-5°	
		3	G, H			Lossa skruven. 180°
		4	G, H	M = 7 ± 2 Nm		
		5	G, H		180° + 10° /-5°	
<b>3</b>		1	A, B	M = 6 ± 0.6 Nm		
		2	A, B		70° + 15° /-5°	
<b>4</b>						för apparater 912 160 002 0
		1	A, B, C, D	M = 20 ± 2 Nm		Kontrollera att alla skruvar har rätt åtdragningsmoment innan du går vidare till nästa arbetsmoment.
		2	A, B, C, D		90° + 10° /-5°	
		3	E			Lossa skruven. 180°
		4	E	M = 7 ± 2 Nm		
		5	E		90° + 10° /-5°	
<b>5</b>						för apparater 912 160 000 0, 912 116 002 0
		1	A, B, C, D	M = 20 ± 2 Nm		Kontrollera att alla skruvar har rätt åtdragningsmoment innan du går vidare till nästa arbetsmoment.
		2	A, B, C, D		90° + 10° /-5°	
		3	E, F, G, H, I, J, K			Lossa skruven. 180°
		4	E, F, G, H, I, J, K	M = 7 ± 2 Nm		
		5	E, F, G, H, I, J, K		90° + 10° /-5°	
<b>6</b>						för apparater 912 160 001 0
		1	A, B, C, D	M = 20 ± 2 Nm		Kontrollera att alla skruvar har rätt åtdragningsmoment innan du går vidare till nästa arbetsmoment.
		2	A, B, C, D		90° + 10° /-5°	
		3	E			Lossa skruven. 180°
		4	E	M = 10 ± 1 Nm		
		5	E		90° + 10° /-5°	
<b>1</b>						Beakta monteringsläget.

**Semboller&belirti sözleri**

- ⚠ DANGER** TEHLİKE Tehlikeli durum: ciddi personel yaralanması veya ölüm riski.
- ⚠ WARNING** DİKKAT Tehlike riski: hafif personel yaralanması veya maddi zarar.
- ⚠ CAUTION** UYARI Ciddi personel yaralanması veya ölüm riski.
- Yuvarlak içinde numarası belirtilen parça numaraları kit içerisinde bulunur.
- ↺ Dönüş açısı.

**i** Talimat/ Doğru tamir için bilgi

**📄** Tabloda belirtilen parçalar için kit kullanılabilir.

**⚙** Elemanı belirtilen sıkma torku ya da dönme açısı ile sıkın.















**NOTE** Talimat/ Doğru tamir için bilgi

**Genel tamir bilgisi**

1. Araçların güvenlik sistemlerinde tamir işlemlerini yalnızca eğitim almış konusunda uzman personeller gerçekleştirebilir.
2. Araç üretici firma özellikler ve talimatlarına kesinlikle uyunuz.
3. Şirket emniyet kuralları ve ulusal regülasyonlarına uyunuz.
4. Sadece WABCO veya üretici firma tarafından yayınlanan yedek parçaları kullanın.
5. Tamire, tamir işlemi için gerekli olan tüm bilgileri okuyup anladıktan sonra başlayınız. Ayrıca gerekli olan dokümanlar: Test talimatı, yedek parça sayfası, genel tamir ve test bilgileri (815 140 109 3). Tümünü linki altında, online ürün kataloğu INFORM'da cihaza ait ürün numarasını veya baskı numarasını girerek bulabilirsiniz.
6. Tamir edilmiş her cihazı - test talimatına uygun şekilde - uygun bir donanımla işlevsellik ve sızdırmazlık konusunda kontrol edin.
7. WABCO tamir edilmiş bir cihazın işlevselliği veya kalitesi için hiçbir sorumluluk üstlenmemektedir.

tr





### Montaj sırası

Resim	Sembol	Prosedür	Sıra:	Tork:	Dönüş açısı:	Yorumlar
<b>1+2</b>	<b>T</b> 1					Cihazlar için 912 512 005 0, 912 512 006 0, 912 512 007 0, 912 514 003 0, 912 550 000 0, 912 550 000 2, 912 550 002 0, 912 550 003 0, 912 550 004 0, 912 550 006 0, 912 550 007 0, 912 550 009 0, 912 560 007 0, 912 560 008 0, 912 560 009 0, 912 562 000 0
		1	A, B, C, D, E, F	M = 20 ± 2 Nm		Bir sonraki iş adımından önce, tüm cıvataların doğru torka sahip olduklarından emin olun.
		2.1	A, B, C, D, E, F		90° +10° /-5°	
		2.2	A, B, C, D, E, F		90° +10° /-5°	
		3	G, H			Vidayı sökün.180°
		4	G, H	M = 7 ± 2 Nm		
		5	G, H		180° + 10° /-5°	
<b>3</b>	<b>T</b> 2					
		1	A, B	M = 6 ± 0.6 Nm		
		2	A, B		70° + 15° /-5°	
<b>4</b>	<b>T</b> 3					Cihazlar için 912 160 002 0
		1	A, B, C, D	M = 20 ± 2 Nm		Bir sonraki iş adımından önce, tüm cıvataların doğru torka sahip olduklarından emin olun.
		2	A, B, C, D		90° + 10° /-5°	
		3	E			Vidayı sökün.180°
		4	E	M = 7 ± 2 Nm		
		5	E		90° + 10° /-5°	
<b>5</b>	<b>T</b> 4					Cihazlar için 912 160 000 0, 912 116 002 0
		1	A, B, C, D	M = 20 ± 2 Nm		Bir sonraki iş adımından önce, tüm cıvataların doğru torka sahip olduklarından emin olun.
		2	A, B, C, D		90° + 10° /-5°	
		3	E, F, G, H, I, J, K			Vidayı sökün.180°
		4	E, F, G, H, I, J, K	M = 7 ± 2 Nm		
		5	E, F, G, H, I, J, K		90° + 10° /-5°	
<b>6</b>	<b>T</b> 5					Cihazlar için 912 160 001 0
		1	A, B, C, D	M = 20 ± 2 Nm		Bir sonraki iş adımından önce, tüm cıvataların doğru torka sahip olduklarından emin olun.
		2	A, B, C, D		90° + 10° /-5°	
		3	E			Vidayı sökün.180°
		4	E	M = 10 ± 1 Nm		
		5	E		90° + 10° /-5°	
<b>1</b>	<b>i</b>					Montaj konumuna dikkat.





pt

## Símbolos e Significados

-  **DANGER** Perigo! Risco de acidente iminente: lesão corporal grave e/ou risco de morte.
-  **WARNING** Cuidado! Possível situação de acidente: ferimentos leves/moderados e/ou danos materiais.
-  **CAUTION** Atenção! Possível situação de acidente: lesão corporal grave e/ou risco de morte.
-  Componentes que estão marcados com um círculo compõem o jogo de reparo.
-  Ângulo de rotação.

 Instrução/Informação para uma correta reparação.

 O jogo de reparo pode ser utilizado nos produtos relacionados na tabela.

 Apertar o elemento com o binário ou o ângulo de rotação indicado.





















**NOTE** Instrução/Informação para uma correta reparação.

## Dicas Gerais para Reparação

1. Por motivo de segurança, somente pessoas qualificadas devem efetuar reparação nos sistemas de freio do veículo.
2. Siga sempre as recomendações/especificações do fabricante do veículo.
3. Mantenha e siga as orientações de prevenção de acidentes vigentes e/ou impostas pelos órgãos competentes.
4. Use somente peças de reposição aprovadas pela WABCO ou pelo fabricante do veículo.
5. Somente inicie o trabalho de reparação após ler e entender todas as informações necessárias para realizar uma reparação. Documentos adicionais necessários: instrução de teste, lista de peças sobressalentes, dicas gerais de testes e reparação (815 130 109 3) podem ser encontrados no site [www.wabco-auto.com](http://www.wabco-auto.com) ao inserir o número do produto.
6. Verificar cada produto reparado conforme instruções de teste, utilizando os equipamentos necessários e local adequado.
7. A WABCO não assume qualquer responsabilidade pela função ou qualidade de um equipamento reparado.





pt

## Sequência de montagem

Figura	Símbolo	Procedimento	Sequência:	Torque:	Ângulo de rotação:	Comentários
<b>1+2</b>						Para conjuntos 912 512 005 0, 912 512 006 0, 912 512 007 0, 912 514 003 0, 912 550 000 0, 912 550 000 2, 912 550 002 0, 912 550 003 0, 912 550 004 0, 912 550 006 0, 912 550 007 0, 912 550 009 0, 912 560 007 0, 912 560 008 0, 912 560 009 0, 912 562 000 0
		1	A, B, C, D, E, F	M = 20 ± 2 Nm		O manuseamento deste componente requer uma proteção contra a descarga eletrostática (ESD).
		2.1	A, B, C, D, E, F		90° + 10° /-5°	
		2.2	A, B, C, D, E, F		90° + 10° /-5°	
		3	G, H			Desparafusar o parafuso 180°
		4	G, H	M = 7 ± 2 Nm		
		5	G, H		180° + 10° /-5°	
<b>3</b>		1	A, B	M = 6 ± 0.6 Nm		
		2	A, B		70° + 15° /-5°	
<b>4</b>						Para conjuntos 912 160 002 0
		1	A, B, C, D	M = 20 ± 2 Nm		O manuseamento deste componente requer uma proteção contra a descarga eletrostática (ESD).
		2	A, B, C, D		90° + 10° /-5°	
		3	E			Desparafusar o parafuso 180°
		4	E	M = 7 ± 2 Nm		
		5	E		90° + 10° /-5°	
<b>5</b>						Para conjuntos 912 160 000 0, 912 116 002 0
		1	A, B, C, D	M = 20 ± 2 Nm		O manuseamento deste componente requer uma proteção contra a descarga eletrostática (ESD).
		2	A, B, C, D		90° + 10° /-5°	
		3	E, F, G, H, I, J, K			Desparafusar o parafuso 180°
		4	E, F, G, H, I, J, K	M = 7 ± 2 Nm		
		5	E, F, G, H, I, J, K		90° + 10° /-5°	
<b>6</b>						Para conjuntos 912 160 001 0
		1	A, B, C, D	M = 20 ± 2 Nm		O manuseamento deste componente requer uma proteção contra a descarga eletrostática (ESD).
		2	A, B, C, D		90° + 10° /-5°	
		3	E			Desparafusar o parafuso 180°
		4	E	M = 10 ± 1 Nm		
		5	E		90° + 10° /-5°	
<b>1</b>						Observar a posição de montagem

ko

## Symbols & Signal Words

-  **DANGER** 급박한 위험 상황: 심각한 상해 또는 사망에 이르게 할 수도 있습니다.
-  **WARNING** 잠재적 위험 상황: 경미하거나 완화된 부상 또는 물질적 손실을 입을 수 있습니다.
-  **CAUTION** 잠재적 위험 상황: 심각한 상해 또는 사망에 이르게 할 수도 있습니다.
-  본 키트에는 원숫자로 표기된 제품들만 포함되어 있습니다.
-  회전 각도.

 올바른 수리를 위한 설명 / 정보

 표를 참조하여 제품에 대한 키트를 사용할 수 있습니다.

 제시된 토크 및 회전각으로 요소를 조이십시오.

**NOTE** 올바른 수리를 위한 설명 / 정보

1. 자격이 있는 전문 정비사만이 차량의 안전 시스템을 수리하실 수 있습니다.
2. 꼭 차량제조사 사양과 지침서를 따르십시오.
3. 회사의 사고예방 규제와 국내 법적 규제를 지키십시오.
4. 와브코 또는 차량 제조사로부터 제공된 예비부품만을 사용하십시오.
5. 항상 수리에 필요한 모든 정보를 읽고 이해했을 때만 작업을 시작하십시오. 추가적으로 필요한 간행물: 검사지침, 예비부품 리스트, 일반적인 수리 및 검사 참고사항 (815 010 109 3)은 와브코 홈페이지 [www.wabco-auto.com](http://www.wabco-auto.com)의 INFORM으로 들어가셔서 제품번호 또는 간행물 번호를 조회하여 찾으실 수 있습니다.
6. 기능적 효율과 견고함을 위해 검사지침에 따라 각 수리장비들을 적절한 설비위에서 체크해 보시기 바랍니다.
7. 와브코는 수리된 제품의 품질과 기능에 대해 어떠한 책임도 지지 않습니다.

ko

그림	기호	절차	순서:	토크:	회전 각도:	주석
<b>1+2</b>	 1					제품에 한함. 912 512 005 0, 912 512 006 0, 912 512 007 0, 912 514 003 0, 912 550 000 0, 912 550 000 2, 912 550 002 0, 912 550 003 0, 912 550 004 0, 912 550 006 0, 912 550 007 0, 912 550 009 0, 912 560 007 0, 912 560 008 0, 912 560 009 0, 912 562 000 0
		1	A, B, C, D, E, F	M = 20 ± 2 Nm		다음 절차를 실행하기 전에 모든 나사에 정확한 토크가 주어졌는지 확인하십시오.
		2.1	A, B, C, D, E, F		90° + 10° / -5°	
		2.2	A, B, C, D, E, F		90° + 10° / -5°	
		3	G, H			나사를 풀어 주십시오. 180°
		4	G, H	M = 7 ± 2 Nm		
		5	G, H		180° + 10° / -5°	
<b>3</b>	 2	1	A, B	M = 6 ± 0.6 Nm		
		2	A, B		70° + 15° / -5°	
<b>4</b>	 3					제품에 한함. 912 160 002 0
		1	A, B, C, D	M = 20 ± 2 Nm		다음 절차를 실행하기 전에 모든 나사에 정확한 토크가 주어졌는지 확인하십시오.
		2	A, B, C, D		90° + 10° / -5°	
		3	E			나사를 풀어 주십시오. 180°
		4	E	M = 7 ± 2 Nm		
		5	E		90° + 10° / -5°	
<b>5</b>	 4					제품에 한함. 912 160 000 0, 912 116 002 0
		1	A, B, C, D	M = 20 ± 2 Nm		다음 절차를 실행하기 전에 모든 나사에 정확한 토크가 주어졌는지 확인하십시오.
		2	A, B, C, D		90° + 10° / -5°	
		3	E, F, G, H, I, J, K			나사를 풀어 주십시오. 180°
		4	E, F, G, H, I, J, K	M = 7 ± 2 Nm		
		5	E, F, G, H, I, J, K		90° + 10° / -5°	
<b>6</b>	 5					제품에 한함. 912 160 001 0
		1	A, B, C, D	M = 20 ± 2 Nm		다음 절차를 실행하기 전에 모든 나사에 정확한 토크가 주어졌는지 확인하십시오.
		2	A, B, C, D		90° + 10° / -5°	
		3	E			나사를 풀어 주십시오. 180°
		4	E	M = 10 ± 1 Nm		
		5	E		90° + 10° / -5°	
<b>1</b>						장착 위치를 준수 하십시오.