

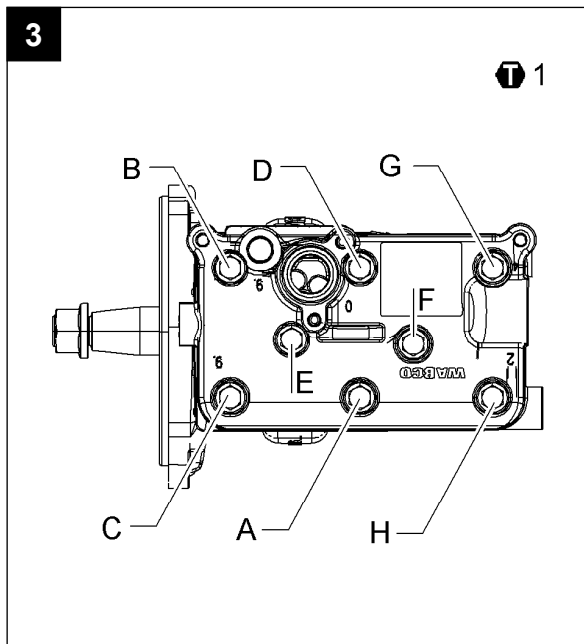

- 912 112 001 0
- 912 112 002 0
- 912 142 001 0
- 912 142 002 0
- 912 151 000 0
- 912 151 001 0
- 912 512 008 0
- 912 512 014 0
- ↓
- 912 512 017 0
- 912 512 021 0
- 912 512 023 0
- 912 512 024 0
- 912 512 026 0
- 912 512 027 0
- 912 512 029 0
- 912 514 004 0
- 912 514 009 0
- 912 542 002 0
- 912 542 007 0
- 912 551 002 0

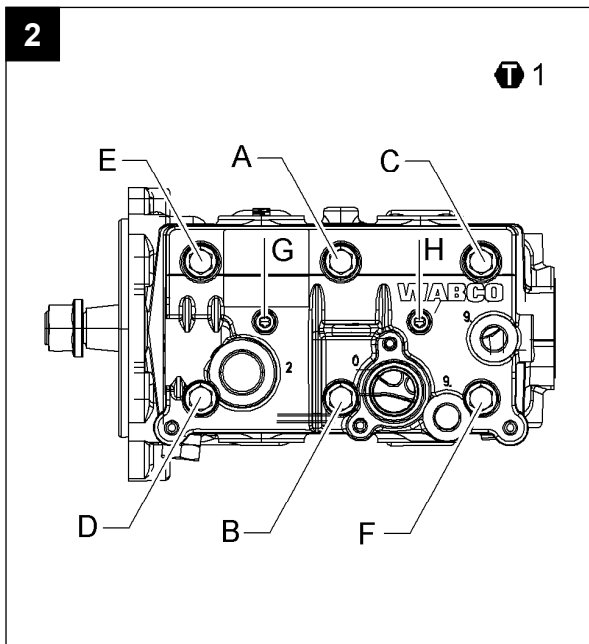

## Signální slova a symboly

-  **DANGER** NEBEZPEČÍ Bezprostředně hrozící nebezpečí: těžká újma na zdraví nebo smrt
-  **WARNING** POZOR Možná nebezpečná situace: jako následek lehká nebo středně těžká újma na zdraví nebo poškození majetku
-  **CAUTION** VÝSTRAHA Možná nebezpečná situace: jako následek těžká újma na zdraví nebo smrt
-  Díly, které mají číslo pozice v kroužku, jsou obsažené v opravárenské sadě.

 Instrukce / informace ke správnému provedení opravy

 Opravárenskou sadu je možné použít pro přístroje uvedené v tabulce.











 Součástku utáhněte uvedeným momentem.

**NOTE** Instrukce / informace ke správnému provedení opravy

## Všeobecné pokyny k opravám





1. Opravárenské práce na přístrojích systému, který má vliv na bezpečnost vozidla, smí provádět pouze kvalifikovaný personál odborné servisní dílny.
3. Dodržujte předpisy BOZP podniku a národní předpisy.
5. S opravou začněte teprve tehdy, až všechny informace nutné pro opravu přečtete a porozumíte jim. Další potřebné dokumenty: zkušební postup, list náhradních dílů, všeobecné pokyny pro opravu a kontrolu (815 150 109 3) naleznete na internetových stránkách: [www.wabco-auto.com](http://www.wabco-auto.com), když v databázi INFORM zadáte produktové číslo přístroje nebo číslo dokumentu.
2. Postupujte bezpodmínečně podle pokynů a instrukcí výrobce vozidla.
4. Používejte výhradně náhradní díly od firmy WABCO nebo díly schválené výrobcem vozidla.
6. Na adekvátním zařízení přezkoušejte – podle zkušebního postupu – každý opravený přístroj na funkčnost a těsnost.

## Postup montáže

Obrázek	Symbol	Pozice	Pořadí:	Utahovací moment:	Úhel pootočení pro dotažení:	Poznámky
<b>1</b>	 2	6	A, B	6 ± 0,6 Nm		
			A, B		70° + 15° / - 5°	
	 3	9		270 ± 20 Nm		
	 1	6				Dbejte na správnost montážní polohy.
	 2	7				Nasadte s lepidlem.: Loctite 648, Euro-Lock A 64.80
<b>1+2</b>	 1	2	A, B, C, D, E, F	20 ± 2 Nm		pro přístroje: 912 512 008 0, ... 014 0 - ... 017 0, ... 021 0, ... 023 0, ... 024 0, ... 026 0, ... 027 0, ... 029 0, 912 514 004 0, ... 009 0, 912 542 002 0, ... 007 0, 912 551 002 0, 912 562 000 0
			A, B, C, D, E, F		90° + 10° / - 5°	(25 ± 2 Nm)
			A, B, C, D, E, F		90° + 10° / - 5°	
<b>1+3</b>	 1	2	E, F, G, H	10 ± 2 Nm		pro přístroje: 912 112 001 0, 912 142 001 0, 912 151 000 0
			A, B, C, D	25 ± 2 Nm		
			A, B, C, D		90° + 10° / - 5°	
			E, F, G, H		120° + 10° / - 10°	(10 Nm)

de

## Signalwörter & Symbole

-  **DANGER** GEFAHR Unmittelbar drohende Gefährdung: Schwere Personenschäden oder Tod
-  **WARNING** VORSICHT Mögliche Gefahrensituation: Leichte oder mittelschwere Personenschäden oder Sachschäden als Folge
-  **CAUTION** WARNUNG Mögliche Gefahrensituation: Tod oder schwere Personenschäden als Folge
-  Teile mit Kreis um die Positionsnummer sind im Reparatursatz enthalten.

 Anweisung / Information für eine korrekte Reparatur

 Der Reparatursatz kann für Geräte entsprechend Tabelle verwendet werden.















 Element mit angegebenen Drehmoment anziehen.

**NOTE** Anweisung / Information für eine korrekte Reparatur

## Allgemeine Reparaturhinweise





1. Reparaturarbeiten an Geräten eines Fahrzeug-Sicherheitssystems darf nur qualifiziertes Personal einer Fachwerkstatt durchführen.
3. Halten Sie Unfallverhütungsvorschriften des Betriebes sowie nationale Vorschriften ein.
5. Beginnen Sie die Reparatur erst dann, wenn Sie alle Informationen, die für die Reparatur notwendig sind, gelesen und verstanden haben. Zusätzlich benötigte Dokumente: Prüfanweisung, Ersatzteilblatt, Allgemeine Reparatur- und Prüfinweise (815 020 109 3) zu finden auf [www.wabco-auto.com](http://www.wabco-auto.com) mittels Eingabe der Produktnummer des Gerätes bzw. Druckschriftennummer in INFORM.
2. Leisten Sie den Vorgaben und Anweisungen des Fahrzeugherstellers unbedingt Folge.
4. Verwenden Sie ausschließlich von WABCO oder vom Fahrzeughersteller freigegebene Ersatzteile.
6. Prüfen Sie jedes reparierte Gerät – gemäß Prüfanweisung – an einer adäquaten Einrichtung auf Funktionstüchtigkeit und Dichtigkeit.

## Montage Reihenfolge

Bild	Symbol	Position	Reihenfolge:	Anzugsdrehmoment:	Weiterdrehwinkel:	Bemerkungen
	 2	6	A, B	6 ± 0,6 Nm		
			A, B		70° + 15° / - 5°	
	 3	9		270 ± 20 Nm		
	 1	6				Einbaulage beachten.
	 2	7				Mit Klebemittel einsetzen: Loctite 648, Euro-Lock A 64.80
	 1	2	A, B, C, D, E, F	20 ± 2 Nm		für Geräte: 912 512 008 0, ... 014 0 - ... 017 0, ... 021 0, ... 023 0, ... 024 0, ... 026 0, ... 027 0, ... 029 0, 912 514 004 0, ... 009 0, 912 542 002 0, ... 007 0, 912 551 002 0, 912 562 000 0
			A, B, C, D, E, F		90° + 10° / - 5°	(25 ± 2 Nm)
			A, B, C, D, E, F		90° + 10° / - 5°	
	 1	2	E, F, G, H	10 ± 2 Nm		für Geräte: 912 112 001 0, 912 142 001 0, 912 151 000 0
			A, B, C, D	25 ± 2 Nm		
			A, B, C, D		90° + 10° / - 5°	
			E, F, G, H		120° + 10° / - 10°	(10 Nm)

en

## Symbols & Signal Words

-  **DANGER** Imminent hazard situation: serious personal injury or death as a result
-  **WARNING** Possible hazard situation: minor or moderate personal injury or material loss as a result
-  **CAUTION** Possible hazard situation: serious personal injury or death as a result
-  Parts having item numbers with circles are included in the kit.

 Instruction / Information for a correct repair

 The kit can be used for devices according table.

 Fasteners must be tightened to a specific torque.











**NOTE** Instruction / Information for a correct repair

en

## General Repair Hints





1. Only qualified personnel of a specialist workshop are authorized to perform repair work on a vehicle's security system.
2. Absolutely follow specifications and instructions of vehicle manufacturer.
3. Keep to company's relevant accident prevention regulations and national regulations.
4. Use only spare parts released by WABCO or vehicle manufacturer.
5. Always start repair work only when you have read and understood all information required for repair. Documents additionally needed: Test Instruction, Spare Parts List, General Repair and Test Hints (815 010 109 3) to be found on [www.wabco-auto.com](http://www.wabco-auto.com) by entering product number of the device or the publication number in INFORM.
6. Check each repaired equipment for functional efficiency and tightness on an adequate facility according to the test instruction.



## Sequence of assembly

Picture	Symbol	Item	Sequence:	Torque:	Rotation angle:	Comments
<b>1</b>		2	6	A, B	6 ± 0,6 Nm	
			A, B		70° + 15° / - 5°	
		3	9		270 ± 20 Nm	
		1	6			Observe installation position.
		2	7			Assembled with adhesive: Loctite 648, Euro-Lock A 64.80
<b>1+2</b>		1	2	A, B, C, D, E, F	20 ± 2 Nm	for devices: 912 512 008 0, ... 014 0 - ... 017 0, ... 021 0, ... 023 0, ... 024 0, ... 026 0, ... 027 0, ... 029 0, 912 514 004 0, ... 009 0, 912 542 002 0, ... 007 0, 912 551 002 0, 912 562 000 0
			A, B, C, D, E, F		90° + 10° / - 5°	(25 ± 2 Nm)
			A, B, C, D, E, F		90° + 10° / - 5°	
<b>1+3</b>		1	2	E, F, G, H	10 ± 2 Nm	for devices: 912 112 001 0, 912 142 001 0, 912 151 000 0
			A, B, C, D	25 ± 2 Nm		
			A, B, C, D		90° + 10° / - 5°	
			E, F, G, H		120° + 10° / - 10°	(10 Nm)

es

## Símbolos & Palabras de aviso

-  **DANGER** PELIGRO Situación de peligro inminente: Pueden ocasionarse daños personales graves o incluso mortales
-  **WARNING** CUIDADO Posible situación de peligro: Pueden ocasionarse daños personales leves o moderados o pérdidas materiales
-  **CAUTION** ADVERTENCIA Posible situación de peligro: Pueden ocasionarse daños personales graves o incluso mortales
-  Los componentes incluidos en el kit son los números que aparecen con círculo.











-  Instrucciones/Información para una correcta reparación
-  El kit puede ser utilizado en los equipos que aparecen en la tabla.
-  Los cierres deben apretarse con un par de apriete determinado.
- NOTE** Instrucciones/Información para una correcta reparación

es

## Consejos generales de reparación





- Sólo el personal cualificado de un taller especializado está autorizado para realizar las tareas de reparación en los sistemas de seguridad de los vehículos.
- Atenerse exactamente a las indicaciones e instrucciones del fabricante del vehículo.
- Siga las regulaciones y normas acerca de prevención de riesgos laborales de su empresa y de su país.
- Utilice piezas de repuesto suministradas por WABCO o el fabricante del vehículo.
- Comience la reparación sólo cuando haya leído y comprendido las instrucciones de reparación. Documentos adicionales necesarios: Instrucciones de comprobación, listas de despiece, consejos generales de comprobación y reparación (815 040 109 3), los cuales pueden encontrarse en [www.wabco-auto.com](http://www.wabco-auto.com), introduciendo la referencia del aparato o la referencia de la publicación en la aplicación INFORM.
- Compruebe la eficacia de funcionamiento y de ajuste de cada equipo reparado en unas instalaciones adecuadas según las instrucciones de comprobación.



## Montaje sucesión

Dibujo	Símbolo	Posición	Secuencia de serraggio:	Par de apriete:	Ángulo de rotación:	Observaciones
<b>1</b>	 2	6	A, B	6 ± 0,6 Nm		
			A, B		70° + 15° / - 5°	
	 3	9		270 ± 20 Nm		
	 1	6				Prestar atención a la posición de instalación.
	 2	7				Montado con adhesivo: Loctite 648, Euro-Lock A 64.80
<b>1+2</b>	 1	2	A, B, C, D, E, F	20 ± 2 Nm		para aparatos: 912 512 008 0, ... 014 0 - ... 017 0, ... 021 0, ... 023 0, ... 024 0, ... 026 0, ... 027 0, ... 029 0, 912 514 004 0, ... 009 0, 912 542 002 0, ... 007 0, 912 551 002 0, 912 562 000 0
			A, B, C, D, E, F		90° + 10° / - 5°	(25 ± 2 Nm)
			A, B, C, D, E, F		90° + 10° / - 5°	
<b>1+3</b>	 1	2	E, F, G, H	10 ± 2 Nm		para aparatos: 912 112 001 0, 912 142 001 0, 912 151 000 0
			A, B, C, D	25 ± 2 Nm		
			A, B, C, D		90° + 10° / - 5°	
			E, F, G, H		120° + 10° / - 10°	(10 Nm)

fr

## Symboles & Significations

-  **DANGER** DANGER Situation de danger imminent : Danger de mort ou de dommage corporel sérieux.
-  **WARNING** ATTENTION Situation de danger probable : Risque de dommage corporel mineur ou modéré ou perte de matériel.
-  **CAUTION** AVERTISSEMENT Situation de danger de danger probable : Danger de mort ou de dommages corporel sérieux
-  Les composants avec repères entourés sont inclus dans le kit.

-  Instruction/Information pour une réparation correcte
-  Le kit peut être utilisé pour les appareils indiqués sur le Feuille.
-  Les fixations doivent être serrées à un couple spécifique.
- NOTE** Instruction/Information pour une réparation correcte

fr

## Conseils généraux de réparation

- Uniquement le personnel qualifié d'un atelier agréé WABCO est autorisé à effectuer la réparation sur les systèmes de sécurité d'un véhicule.
- Respecter toujours les prescriptions et instructions du constructeur du véhicule.
- Veillez aux règlements de prévention des accidents indiqués par votre société et aux règlements nationaux.
- Employez seulement les pièces de rechange WABCO ou du constructeur du véhicule.
- Commencez toujours le travail de réparation seulement après avoir lu et compris toutes les informations indiquées pour la réparation. Documentation complémentaire nécessaire : Instruction d'essai, liste des pièces détachées, instructions de réparation et conseils d'essai (815 030 109 3) en tapant la référence du produit ou le numéro de la publication dans INFORM sur internet : [www.wabco-auto.com](http://www.wabco-auto.com)
- Examinez chaque appareil réparé pour s'assurer de l'efficacité fonctionnelle et de l'étanchéité selon l'instruction d'essai.

## Les montages ordre

Image	Symbole	Position	Sequence:	Couple de serrage:	Angle de rotation:	Remarques
	2	6	A, B	6 ± 0,6 Nm		
			A, B		70° + 15° / - 5°	
	3	9		270 ± 20 Nm		
	1	6				Faire attention à la position de montage.
	2	7				Assembler avec de la colle: Loctite 648, Euro-Lock A 64.80
	1	2	A, B, C, D, E, F	20 ± 2 Nm		pour appareils: 912 512 008 0, ... 014 0 - ... 017 0, ... 021 0, ... 023 0, ... 024 0, ... 026 0, ... 027 0, ... 029 0, 912 514 004 0, ... 009 0, 912 542 002 0, ... 007 0, 912 551 002 0, 912 562 000 0
			A, B, C, D, E, F		90° + 10° / - 5°	(25 ± 2 Nm)
			A, B, C, D, E, F		90° + 10° / - 5°	
	1	2	E, F, G, H	10 ± 2 Nm		pour appareils: 912 112 001 0, 912 142 001 0, 912 151 000 0
			A, B, C, D	25 ± 2 Nm		
			A, B, C, D		90° + 10° / - 5°	
			E, F, G, H		120° + 10° / - 10°	(10 Nm)

hr

## Simboli & Značenja

- DANGER** OPREZ Neposredna rizična situacija: moguće ozbiljno ozljeđivanje ili smrt
- WARNING** OPASNOST neposredna rizična situacija: moguće manje ozljeđivanje materijalna šteta
- CAUTION** UPOZORENJE Neposredna rizična situacija: moguće ozbiljno ozljeđivanje ili smrt
- Dijelovi uređaja čiji su brojevi zaokruženi nalaze se u kompletu..

Informacija o ispravnom popravku.

Set može biti korišten za uređaje prema tabeli.

Spone moraju biti stegnute prema specifičnim silama zatezanja.







**NOTE** Informacija o ispravnom popravku.

## Opće upute o popravcima

- Samo kvalificirane osobe istručnjaci smiju popravljati sigurnosne sustave na vozilu.
- U potpunosti slijedi specifikacije i upute proizvođača vozila.
- Provodi tvrtkine sigurnosne propise kao i nacionalne propise o sigurnosti
- Koristi rezervne dijelove proizvedene od WABCA ili proizvođača vozila..
- Popravak počni tek nakon što pročitaš i shvatiš upute o popravku. Potrebni dokumenti: Instrukcije o testiranju, Lista rezervnih dijelova, Opće natuknice o popravku i testiranju (815 010 109 3) mogu se naći na [www.wabco-auto.com](http://www.wabco-auto.com) nakon upisa kataložnog broja proizvoda ili publikacije u INFORM-u.
- Provjeri svaki popravljeni uređaj kako radi i da li je zategnuto sve kako treba prema odgovarajućim uputama o testiranju proizvoda.





hr



## Redosljijed ugradnje

Slika	Simbol	Pojedin- ost	Redosljijed:	Zakretni moment:	Kut zakretanja:	Komentar
<b>1</b>	 2	6	A, B	6 ± 0,6 Nm		
			A, B		70° + 15° / - 5°	
	 3	9		270 ± 20 Nm		
	 1	6				Provjeri položaj ugradnje.
	 2	7				Sklopljeno ljepljenjem.: Loctite 648, Euro-Lock A 64.80
<b>1+2</b>	 1	2	A, B, C, D, E, F	20 ± 2 Nm		za uređaj: 912 512 008 0, ... 014 0 - ... 017 0, ... 021 0, ... 023 0, ... 024 0, ... 026 0, ... 027 0, ... 029 0, 912 514 004 0, ... 009 0, 912 542 002 0, ... 007 0, 912 551 002 0, 912 562 000 0
			A, B, C, D, E, F		90° + 10° / - 5°	(25 ± 2 Nm)
			A, B, C, D, E, F		90° + 10° / - 5°	
<b>1+3</b>	 1	2	E, F, G, H	10 ± 2 Nm		za uređaj: 912 112 001 0, 912 142 001 0, 912 151 000 0
			A, B, C, D	25 ± 2 Nm		
			A, B, C, D		90° + 10° / - 5°	
			E, F, G, H		120° + 10° / - 10°	(10 Nm)

it

## Simboli e Segnali

-  **DANGER** PERICOLO Imminente situazione di rischio: serie ferite personali fino anche alle morte
-  **WARNING** PRUDENZA Possibili situazioni di pericolo: possibili lievi ferite o perdita di materiale
-  **CAUTION** AVVERTENZA Possibili situazioni di pericolo: serie ferite personali fino anche alle morte
-  I componenti indicati con un numero cerchiato, sono inclusi nel kit.











-  Istruzioni/Informazioni per unacorretta riparazione
-  Il kit può essere usato per gli articoli secondo la tabella.
-  I fissaggi devono essere stretti ad una coppia di serraggio specifica.
- NOTE** Istruzioni/Informazioni per unacorretta riparazione

## Suggerimenti per la riparazione

1. Soltanto il personale qualificato delle officine specializzate è autorizzato ad effettuare le riparazioni sui sistemi di sicurezza dei veicoli.
2. E' assolutamente necessario seguire le istruzioni e le specifiche del costruttore del veicolo.
3. Attenersi alle norme nazionali e aziendali in merito alla prevenzione degli infortuni.
4. Usare solo ricambi originali WABCO o del costruttore del veicolo.
5. Effettuare la riparazione solamente dopo aver letto e capito tutte le informazioni richieste per la riparazione. Ulteriori informazioni necessarie: istruzioni di collaudo, catalogo dei ricambi, cenni generali sulla riparazione e test (815 050 109 3) possono essere trovati sul sito [www.wabco-auto.com](http://www.wabco-auto.com) alla voce INFORM entrando per codice del dell'apparecchio o per numero della pubblicazione.
6. Controllare la funzionalità e l'efficienza di ogni apparecchiatura riparata secondo le istruzioni riportate nel manuale di collaudo.





it

## Sequenza di montaggio

Figura	Simbolo	Particol- are	Sequenza:	Coppia di serraggio:	Angolo di rotazione:	Note
<b>1</b>	 2	6	A, B	6 ± 0,6 Nm		
			A, B		70° + 15° / - 5°	
	 3	9		270 ± 20 Nm		
	 1	6				Osservare la posizione di montaggio.
	 2	7				Usare adesivo per il montaggio: Loctite 648, Euro-Lock A 64.80
<b>1+2</b>	 1	2	A, B, C, D, E, F	20 ± 2 Nm		per apparecchi: 912 512 008 0, ... 014 0 - ... 017 0, ... 021 0, ... 023 0, ... 024 0, ... 026 0, ... 027 0, ... 029 0, 912 514 004 0, ... 009 0, 912 542 002 0, ... 007 0, 912 551 002 0, 912 562 000 0
			A, B, C, D, E, F		90° + 10° / - 5°	(25 ± 2 Nm)
			A, B, C, D, E, F		90° + 10° / - 5°	
<b>1+3</b>	 1	2	E, F, G, H	10 ± 2 Nm		per apparecchi: 912 112 001 0, 912 142 001 0, 912 151 000 0
			A, B, C, D	25 ± 2 Nm		
			A, B, C, D		90° + 10° / - 5°	
			E, F, G, H		120° + 10° / - 10°	(10 Nm)

pl

## Hasła ostrzegawcze i symbole

-  **DANGER** NIEBEZPIECZEŃSTWO Bezpośrednie zagrożenie ciężkimi obrażeniami bądź śmiercią.
-  **WARNING** UWAGA! Niebezpieczeństwo grożące lekkimi bądź średnimi obrażeniami.
-  **CAUTION** OSTRZEŻENIE Niebezpieczeństwo grożące śmiercią bądź ciężkimi obrażeniami.
-  Części oznaczone kółkiem wokół numeru pozycji należą do zestawu naprawczego.

 Wskazówki / Informacje dotyczące poprawnej naprawy.

 Zestaw naprawczy może być używany do urządzeń według tabeli.

 Dokręcić element podanym momentem obrotowym.

**NOTE** Wskazówki / Informacje dotyczące poprawnej naprawy.

## Ogólne porady naprawcze

1. Prace naprawcze w obrębie urządzeń układu bezpieczeństwa pojazdu mogą być wykonane jedynie przez wykwalifikowany personel specjalistycznego warsztatu.
3. Należy przestrzegać zakładowych i krajowych przepisów BHP.
5. Naprawę należy rozpocząć dopiero wówczas, gdy wszystkie potrzebne do niej informacje zostaną przeczytane i zrozumiane. Dokumenty potrzebne dodatkowo: instrukcja kontrolna, tabela części zamiennych, ogólne wskazówki dotyczące naprawy i kontroli (815 020 109 3) znajdują Państwo na stronie internetowej [www.wabco-auto.com](http://www.wabco-auto.com), podając numer urządzenia bądź numer publikacji w bazie INFORM.
2. Należy koniecznie postępować według wytycznych i wskazówek producenta pojazdu.
4. Należy używać wyłącznie części zamiennych dopuszczonych przez firmę WABCO bądź przez producenta pojazdu.
6. Na odpowiednim urządzeniu należy sprawdzić każde naprawiane urządzenie - zgodnie z instrukcją kontrolną - pod kątem sprawności działania i szczelności.



pl

## Kolejność montażu

Obraz	Symbol	Pozycja	Kolejność:	Moment dokręcania:	Kąt obrotu:	Komentarz
<b>1</b>		6	A, B	6 ± 0,6 Nm		
			A, B		70° + 15° / - 5°	
		9		270 ± 20 Nm		
		6				Zwrócić uwagę na położenie montażowe.
		7				Złożone z klejem.: Loctite 648, Euro-Lock A 64.80
<b>1+2</b>		2	A, B, C, D, E, F	20 ± 2 Nm		do urządzeń: 912 512 008 0, ... 014 0 - ... 017 0, ... 021 0, ... 023 0, ... 024 0, ... 026 0, ... 027 0, ... 029 0, 912 514 004 0, ... 009 0, 912 542 002 0, ... 007 0, 912 551 002 0, 912 562 000 0
			A, B, C, D, E, F		90° + 10° / - 5°	(25 ± 2 Nm)
			A, B, C, D, E, F		90° + 10° / - 5°	
<b>1+3</b>		2	E, F, G, H	10 ± 2 Nm		do urządzeń: 912 112 001 0, 912 142 001 0, 912 151 000 0
			A, B, C, D	25 ± 2 Nm		
			A, B, C, D		90° + 10° / - 5°	
			E, F, G, H		120° + 10° / - 10°	(10 Nm)

ru

## Знаки & символы

- DANGER** ОПАСНО Прямая угроза аварийной ситуации: влечет за собой смерть или тяжелые повреждения
- WARNING** ОСТОРОЖНО Опасная ситуация: последствием являются легкие повреждения или повреждения средней тяжести, а также материальный ущерб
- CAUTION** ПРЕДУПРЕЖДЕНИЕ Опасная ситуация: влечет за собой смерть или тяжелые повреждения
- Номера частей, обведенные кружком, Вы найдете в ремкомплекте.

- Указание/информация для проведения надлежащего ремонта
- Ремкомплект может быть использован для приборов соответственно таблице.
- Элемент необходимо подтянуть с помощью заданного момента сопротивления.
- NOTE** Указание/информация для проведения надлежащего ремонта

## Общие указания по ремонту

1. Провождение ремонта приборов данной системы должно производиться только квалифицированным персоналом в специализированной мастерской.
2. Следуйте предписаниям и инструкциям изготовителя транспортного средства.
3. Соблюдайте предписания предприятия по технике безопасности, а также национальные нормы.
4. Используйте только запчасти, допущенные к использованию компанией Wabco или производителем транспортного средства.
5. Проводите ремонт только после того, как вы прочитали и поняли все информации, необходимые для данного процесса. Дополнительные документы: инструкция по тестированию, список запасных частей, общие инструкции по ремонту и проведению испытаний (815 080 109 3) Вы найдете на [www.wabco-auto.com](http://www.wabco-auto.com). Для этого необходимо задать номер нужного прибора или номер брошюры в INFORM.
6. Проконтролируйте каждый отремонтированный прибор- согласно инструкции по тестированию- на работоспособность и герметичность с помощью соответствующего оборудования.





ru



## Порядок действий при монтаже.

Изображение	Символ	Позиция	Последовательность:	Момент сопротивления:	Угол вращения:	Замечания
<b>1</b>	 2	6	A, B	6 ± 0,6 Nm		
			A, B		70° + 15° / - 5°	
	 3	9		270 ± 20 Nm		
	 1	6				Обратите внимание на местоположение при монтаже.
	 2	7				При сборке склеить.: Loctite 648, Euro-Lock A 64.80
<b>1+2</b>	 1	2	A, B, C, D, E, F	20 ± 2 Nm		для приборов: 912 512 008 0, ... 014 0 - ... 017 0, ... 021 0, ... 023 0, ... 024 0, ... 026 0, ... 027 0, ... 029 0, 912 514 004 0, ... 009 0, 912 542 002 0, ... 007 0, 912 551 002 0, 912 562 000 0
			A, B, C, D, E, F		90° + 10° / - 5°	(25 ± 2 Nm)
			A, B, C, D, E, F		90° + 10° / - 5°	
<b>1+3</b>	 1	2	E, F, G, H	10 ± 2 Nm		для приборов: 912 112 001 0, 912 142 001 0, 912 151 000 0
			A, B, C, D	25 ± 2 Nm		
			A, B, C, D		90° + 10° / - 5°	
			E, F, G, H		120° + 10° / - 10°	(10 Nm)

SV

## Signalord & symboler

-  **DANGER** FARA Omedelbar risk: svåra personskador eller dödsfall
-  **WARNING** VARNING Möjlig risk: Lätta eller medelsvåra personskador eller materiella skador
-  **CAUTION** VARNING Möjlig risksituation: Dödsfall eller svåra personskador
-  Delar med inringat positionsnummer ingår i reparationsssatsen.

-  Anvisningar/information för korrekt reparation
-  Reparationsssatsen kan användas för apparater enligt tabellen.
-  Dra åt elementet med angivet åtdragningsmoment.











**NOTE** Anvisningar/information för korrekt reparation

## Allmänna reparationsanvisningar



1. Reparationsarbeten på enheter i fordonssäkerhetssystem får endast genomföras av kvalificerad personal på behörig verkstad.
3. Följ alltid företagets föreskrifter för förebyggande av olycksfall samt gällande nationella föreskrifter.
5. Börja inte med reparationsarbetena förrän du har läst igenom och förstått all nödvändig information. Nödvändiga extradokument: Kontrollanvisning, reservdelsblad, allmän reparation och kontrollinformation (815 070 109 3). Du hittar dokumenten på [www.wabco-auto.com](http://www.wabco-auto.com) genom att mata in apparatens produktnummer eller dokumentnummer i INFORM.
2. Beakta alltid fordonstillverkarens specifikationer och anvisningar.
4. Används endast reservdelar som är godkända av WABCO eller fordonstillverkaren.
6. Varje reparerad apparat ska kontrolleras på funktionsduglighet och täthet på en lämplig anordning enligt kontrollanvisningen.



## SV

### Ordningsföljd för montering

Bild	Symbol	Position	Ordningsföljd:	Åtdragningsmoment:	Åtdragningsvinkel:	Kommentar
<b>1</b>	 2	6	A, B	6 ± 0,6 Nm		
			A, B		70° + 15° / - 5°	
	 3	9		270 ± 20 Nm		
	 1	6				Beakta monteringsläget.
	 2	7				Sätt i med lim: Loctite 648, Euro-Lock A 64.80
<b>1+2</b>	 1	2	A, B, C, D, E, F	20 ± 2 Nm		för apparater: 912 512 008 0, ... 014 0 - ... 017 0, ... 021 0, ... 023 0, ... 024 0, ... 026 0, ... 027 0, ... 029 0, 912 514 004 0, ... 009 0, 912 542 002 0, ... 007 0, 912 551 002 0, 912 562 000 0
			A, B, C, D, E, F		90° + 10° / - 5°	(25 ± 2 Nm)
			A, B, C, D, E, F		90° + 10° / - 5°	
<b>1+3</b>	 1	2	E, F, G, H	10 ± 2 Nm		för apparater: 912 112 001 0, 912 142 001 0, 912 151 000 0
			A, B, C, D	25 ± 2 Nm		
			A, B, C, D		90° + 10° / - 5°	
			E, F, G, H		120° + 10° / - 10°	(10 Nm)







## zh

-  **DANGER** 危险! 直接危险: 导致个人严重伤害或死亡
-  **WARNING** 小心! 可能危险: 导致较小或一般程度人员伤害或物品损失
-  **CAUTION** 警告! 可能危险: 导致个人严重伤害或死亡
- 修包中包含号码带有圆圈的零件。

-  用于正确维修的指导和信息。
-  根据表格所示, 修包可以用于相应的总成维修。
-  紧固件必须根据所指定的力矩上紧。
- NOTE** 用于正确维修的指导和信息。





1. 只有在专业维修店的有资质的人员被授权执行车辆安全系统的维修工作。
2. 完全遵循车辆制造商的规格和安装指导。
3. 遵循公司的相关事故预防条例和国家法规。
4. 仅使用于由威伯科公司或整车制造商发布的备件产品。
5. 当你已经阅读并已理解维修所需要的所有信息后, 才能开始维修工作。此外需要的信息: 试验指导, 备件清单, 通用维修和试验提示 (815 010 109 3) 可以在 [www.wabco-auto.com](http://www.wabco-auto.com) 找到。只需在其上键入产品号码或INFORM中的出版物号码。
6. 根据试验要求在适当的设备上, 检测每个维修设备的功效和紧密性。

zh

图片	符号	零件	顺序:	扭矩:	旋转角度:	注释
<b>1</b>	 2	6	A, B	6 ± 0,6 Nm		
			A, B		70° + 15° / - 5°	
	 3	9		270 ± 20 Nm		
	 1	6				观察安装位置。
	 2	7				用粘结剂装入: Loctite 648, Euro-Lock A 64.80
<b>1+2</b>	 1	2	A, B, C, D, E, F	20 ± 2 Nm		用于产品: 912 512 008 0, ... 014 0 - ... 017 0, ... 021 0, ... 023 0, ... 024 0, ... 026 0, ... 027 0, ... 029 0, 912 514 004 0, ... 009 0, 912 542 002 0, ... 007 0, 912 551 002 0, 912 562 000 0
			A, B, C, D, E, F		90° + 10° / - 5°	(25 ± 2 Nm)
			A, B, C, D, E, F		90° + 10° / - 5°	
<b>1+3</b>	 1	2	E, F, G, H	10 ± 2 Nm		用于产品: 912 112 001 0, 912 142 001 0, 912 151 000 0
			A, B, C, D	25 ± 2 Nm		
			A, B, C, D		90° + 10° / - 5°	
			E, F, G, H		120° + 10° / - 10°	(10 Nm)

tr

## Semboller&amp;belirti sözleri

-  **DANGER** TEHLİKE Tehlikeli durum: ciddi personel yaralanması veya ölüm riski.
-  **WARNING** DİKKAT Tehlike riski: hafif personel yaralanması veya maddi zarar.
-  **CAUTION** UYARI Ciddi personel yaralanması veya ölüm riski.
-  Yuvarlak içinde numarası belirtilen parça numaraları kit içerisinde bulunur.

 Talimat/ Doğru tamir için bilgi

 Tabloda belirtilen parçalar için kit kullanılabilir.

 Vidalar özel tork değerine kadar sıkılmalıdır.











**NOTE** Talimat/ Doğru tamir için bilgi

## Genel tamir bilgisi

- Araçların güvenlik sistemlerinde tamir işlemlerini yalnızca eğitim almış konusunda uzman personeller gerçekleştirebilir.
- Şirket emniyet kuralları ve ulusal regülasyonlarına uyunuz.
- Tamire, tamir işlemi için gerekli olan tüm bilgileri okuyup anladıktan sonra başlayınız. Ayrıca gerekli olan dokümanlar: Test talimatı, yedek parça sayfası, genel tamir ve test bilgileri (815 140 109 3). Tümünü linki altında, online ürün kataloğu INFORM'da cihaza ait ürün numarasını veya baskı numarasını girerek bulabilirsiniz.
- Araç üretici firma özellikler ve talimatlarına kesinlikle uyunuz.
- Sadece WABCO veya üretici firma tarafından yayınlanan yedek parçaları kullanın.
- Tamir edilmiş her cihazı - test talimatına uygun şekilde - uygun bir donanımla işlevsellik ve sızdırmazlık konusunda kontrol edin.





tr



### Montaj sırası

Resim	Sembol	Parça	Sıra:	Tork:	Dönüş açısı:	Yorumlar
<b>1</b>		2	6	A, B	6 ± 0,6 Nm	
				A, B		70° + 15° / - 5°
		3	9		270 ± 20 Nm	
		1	6			Montaj konumuna dikkat.
		2	7			Yapıştırıcı ile yerleştirin: Loctite 648, Euro-Lock A 64.80
<b>1+2</b>		1	2	A, B, C, D, E, F	20 ± 2 Nm	Cihazlar için: 912 512 008 0, ... 014 0 - ... 017 0, ... 021 0, ... 023 0, ... 024 0, ... 026 0, ... 027 0, ... 029 0, 912 514 004 0, ... 009 0, 912 542 002 0, ... 007 0, 912 551 002 0, 912 562 000 0
				A, B, C, D, E, F		90° + 10° / - 5° (25 ± 2 Nm)
				A, B, C, D, E, F		90° + 10° / - 5°
<b>1+3</b>		1	2	E, F, G, H	10 ± 2 Nm	Cihazlar için: 912 112 001 0, 912 142 001 0, 912 151 000 0
				A, B, C, D	25 ± 2 Nm	
				A, B, C, D		90° + 10° / - 5°
				E, F, G, H		120° + 10° / - 10° (10 Nm)

pt

### Símbolos e Significados

-  **DANGER** Perigo! Risco de acidente iminente: lesão corporal grave e/ou risco de morte.
-  **WARNING** Cuidado! Possível situação de acidente: ferimentos leves/moderados e/ou danos materiais.
-  **CAUTION** Atenção! Possível situação de acidente: lesão corporal grave e/ou risco de morte.
-  Componentes que estão marcados com um círculo compõem o jogo de reparo.

-  Instrução/Informação para uma correta reparação.
-  O jogo de reparo pode ser utilizado nos produtos relacionados na tabela.
-  Parafusos/porcas devem ser montados de acordo com o torque especificado.
- NOTE** Instrução/Informação para uma correta reparação.

### Dicas Gerais para Reparação

1. Por motivo de segurança, somente pessoas qualificadas devem efetuar reparação nos sistemas de freio do veículo.
2. Mantenha e siga as orientações de prevenção de acidentes vigentes e/ou impostas pelos órgãos competentes.
3. Somente inicie o trabalho de reparação após ler e entender todas as informações necessárias para realizar uma reparação. Documentos adicionais necessários: instrução de teste, lista de peças sobressalentes, dicas gerais de testes e reparação (815 130 109 3) podem ser encontrados no site [www.wabco-auto.com](http://www.wabco-auto.com) ao inserir o número do produto.
4. Siga sempre as recomendações/especificações do fabricante do veículo.
5. Use somente peças de reposição aprovadas pela WABCO ou pelo fabricante do veículo.
6. Verificar cada produto reparado conforme instruções de teste, utilizando os equipamentos necessários e local adequado.

pt

## Sequência de montagem

Figura	Símbolo	Item	Sequência:	Torque:	Ângulo de rotação:	Comentários
<b>1</b>		2	6	A, B	6 ± 0,6 Nm	
			A, B		70° + 15° / - 5°	
		3	9		270 ± 20 Nm	
		1	6			Observar a posição de montagem
		2	7			Montado com adesivo.: Loctite 648, Euro-Lock A 64.80
<b>1+2</b>		1	2	A, B, C, D, E, F	20 ± 2 Nm	Para conjuntos: 912 512 008 0, ... 014 0 - ... 017 0, ... 021 0, ... 023 0, ... 024 0, ... 026 0, ... 027 0, ... 029 0, 912 514 004 0, ... 009 0, 912 542 002 0, ... 007 0, 912 551 002 0, 912 562 000 0
			A, B, C, D, E, F		90° + 10° / - 5°	(25 ± 2 Nm)
			A, B, C, D, E, F		90° + 10° / - 5°	
<b>1+3</b>		1	2	E, F, G, H	10 ± 2 Nm	Para conjuntos: 912 112 001 0, 912 142 001 0, 912 151 000 0
			A, B, C, D	25 ± 2 Nm		
			A, B, C, D		90° + 10° / - 5°	
			E, F, G, H		120° + 10° / - 10°	(10 Nm)

ro

## Simboluri și cuvinte pentru avertizare

- DANGER** Situație de pericol iminentă: poate rezulta vătămare corporală gravă sau deces.
- WARNING** Posibilă situație de pericol: pot rezulta vătămări corporale minore sau medii sau pagube materiale
- CAUTION** Posibilă situație de pericol: poate rezulta vătămare corporală gravă sau deces
- Pieșele cu numărul de articol încercuit sunt incluse în kit.











- Instrucțiuni / Informare pentru o reparare corectă
- Kitul poate fi folosit pentru dispozitive, conform tabelului.
- Elementele de fixare trebuie să fie strânse la un moment specific.
- NOTE** Instrucțiuni / Informare pentru o reparare corectă

## Instrucțiuni generale referitoare la reparație

1. Numai personalul calificat al unui atelier de service specializat este autorizat să efectueze lucrări de reparații pe sistemul de siguranță al vehiculului.
2. Respectați obligatoriu instrucțiunile date de producătorul vehiculului.
3. Respectați prevederile firmei și cele naționale pentru prevenirea accidentelor.
4. Utilizați exclusiv piese de schimb autorizate de WABCO sau de producătorul autovehiculului.
5. Întotdeauna începeți lucrările de reparații numai după ce ați citit și înțeles toate informațiile necesare pentru reparație. Documente suplimentare necesare: Instrucțiuni de testare, Lista pieselor de schimb, Instrucțiuni generale pentru reparare și testare (815 110 109 3) pot fi găsite pe [www.wabco-auto.com](http://www.wabco-auto.com) introducând codul dispozitivului în INFORM.
6. Verifică eficiența funcțională și etanșeitatea fiecărui echipament reparat pe o instalație adecvată în conformitate cu instrucțiunile de testare.





ro



## Secvența asamblării

Imagine	Simbol	Articol	Secvență:	Moment de torsiune:	Unghi de rotire:	Comentarii
<b>1</b>	 2	6	A, B	6 ± 0,6 Nm		
			A, B		70° + 15° / - 5°	
	 3	9		270 ± 20 Nm		
	 1	6				Observați poziția de instalare.
	 2	7				Asamblat cu adeziv: Loctite 648, Euro-Lock A 64.80
<b>1+2</b>	 1	2	A, B, C, D, E, F	20 ± 2 Nm		pentru dispozitive: 912 512 008 0, ... 014 0 - ... 017 0, ... 021 0, ... 023 0, ... 024 0, ... 026 0, ... 027 0, ... 029 0, 912 514 004 0, ... 009 0, 912 542 002 0, ... 007 0, 912 551 002 0, 912 562 000 0
			A, B, C, D, E, F		90° + 10° / - 5°	(25 ± 2 Nm)
			A, B, C, D, E, F		90° + 10° / - 5°	
<b>1+3</b>	 1	2	E, F, G, H	10 ± 2 Nm		pentru dispozitive: 912 112 001 0, 912 142 001 0, 912 151 000 0
			A, B, C, D	25 ± 2 Nm		
			A, B, C, D		90° + 10° / - 5°	
			E, F, G, H		120° + 10° / - 10°	(10 Nm)

ko

&

-  **DANGER** 급박한 위험 상황: 심각한 상해 또는 사망에 이르게 할 수도 있습니다.
-  **WARNING** 잠재적 위험 상황: 경미하거나 완화된 부상 또는 물질적 손실을 입을 수 있습니다.
-  **CAUTION** 잠재적 위험 상황: 심각한 상해 또는 사망에 이르게 할 수도 있습니다.
-  본 키트에는 원숫자로 표기된 제품들만 포함되어 있습니다.

-  올바른 수리를 위한 설명 / 정보
-  표를 참조하여 제품에 대한 키트를 사용하실 수 있습니다.
-  체결품들은 명시된 토크값으로 체결되어야 합니다.

**NOTE** 올바른 수리를 위한 설명 / 정보

1. 자격이 있는 전문 정비사만이 차량의 안전 시스템을 수리하실 수 있습니다.
2. 꼭 차량제조사의 사양과 지침서를 따르십시오.
3. 회사의 사고예방 규제와 국내 법적 규제를 지키십시오.
4. 와브코 또는 차량 제조사로부터 제공된 예비부품만을 사용하십시오.
5. 항상 수리에 필요한 모든 정보를 읽고 이해했을 때만 작업을 시작하십시오. 추가적으로 필요한 간행물: 검사지침, 예비부품 리스트, 일반적인 수리 및 검사 참고사항 (815 010 109 3)은 와브코 홈페이지 [www.wabco-auto.com](http://www.wabco-auto.com)의 INFORM으로 들어가셔서 제품번호 또는 간행물 번호를 조회하여 찾으실 수 있습니다.
6. 기능적 효율과 견고함을 위해 검사지침에 따라 각 수리장비들을 적절한 설비위에서 체크해 보시기 바랍니다.

ko

그림	기호	품목	순서:	토크:	회전 각도:	주석
<b>1</b>	 2	6	A, B	6 ± 0,6 Nm		
			A, B		70° + 15° / - 5°	
	 3	9		270 ± 20 Nm		
	 1	6				장착 위치를 준수 하십시오.
	 2	7				접착제를 사용하여 조립됨.: Loctite 648, Euro-Lock A 64.80
<b>1+2</b>	 1	2	A, B, C, D, E, F	20 ± 2 Nm		제품에 한함.: 912 512 008 0, ... 014 0 - ... 017 0, ... 021 0, ... 023 0, ... 024 0, ... 026 0, ... 027 0, ... 029 0, 912 514 004 0, ... 009 0, 912 542 002 0, ... 007 0, 912 551 002 0, 912 562 000 0
			A, B, C, D, E, F		90° + 10° / - 5°	(25 ± 2 Nm)
			A, B, C, D, E, F			90° + 10° / - 5°
<b>1+3</b>	 1	2	E, F, G, H	10 ± 2 Nm		제품에 한함.: 912 112 001 0, 912 142 001 0, 912 151 000 0
			A, B, C, D	25 ± 2 Nm		
			A, B, C, D		90° + 10° / - 5°	
			E, F, G, H		120° + 10° / - 10°	(10 Nm)