

# TEBS E

## Retrofit Instructions



**WABCO**



# **TEBS E**

## **Retrofit Instructions**

For Semi & Centre Axle Trailers  
with air suspension

Edition 1

This publication is not subject to any update service  
You will find the latest version in INFORM at  
[www.wabco-auto.com](http://www.wabco-auto.com)

© 2009 WABCO

**WABCO**

The right of amendment is reserved.

Version 1/03.2009(en)

815 010 172 3

1	Preparation	5
2	Wheel Sensors & Pole Wheels	5
3	Removing the old system	5
4	Checking of all new components	5
5	Positioning of components for the Roll Stability Support function (RSS)	7
6	Installing the Modulator	7
7	Pneumatic pipe connections	8
8	Pneumatic Extension Module (PEM)	9
9	Electrical connections	9
10	Fitting a Park Release Emergency Valve (PREV)	10
11	Commissioning	11
12	Approval of system	11
13	Annex	12

### Symbols Used

**CAUTION**

Potential hazard situations that can cause minor or moderate to severe injury, or material loss, if the safety instruction is not observed.



Important instructions, information or tips.

- List
- Step
- ➔ Consequence of an action

### Purpose of this publication

The Trailer Electronic Braking System E (TEBS E) with Pneumatic Extension Module (PEM) Retrofit Kit 480 102 932 2 is the ideal way of making sure your trailer braking system is fitted with the most up to date technology, while the PEM contains an Anti Compounding Valve (Double Check Valve) and Charging Valve, so updating part of your conventional braking system.

The following fitting instructions contain information advising you how to fit the 480 102 932 2 Retrofit kit and also about having it approved/signed off upon fitment completion. If you have WABCO Diagnostic Software and have completed an official TEBS E WABCO training course, and have a License Letter giving you access to a PIN number then you can sign off the system yourself.

If you do not have the Software and have not had the training then please contact WABCO Technical on 0113 251 2600 who will advise you of your nearest Service Centre who will sign off the system for you.

## 1 Preparation

Before commencing the installation of WABCO TEBS E on your trailer, it is important to ensure that you have completed and submitted a brake calculation questionnaire and received a finished brake calculation. This calculation contains information needed to program the installed TEBS E system.

**!** If you have any queries you should contact the WABCO technical department on 0113 251 2600.  
"Questionnaire for Trailers fitted with EBS" see annex for copy or contact the technical department.

## 2 Wheel Sensors & Pole Wheels

It is also important to establish which type of ABS sensor and pole wheel is fitted to the vehicle. The WABCO TEBS E system only operates with machined type toothed wheels, the number of teeth depending on the size of wheels used. The pressed steel exciter rings, found on some very early ABS system cannot be used. These components must be replaced with pole wheels with the correct number of teeth, usually 100 teeth for an axle with super single tyres.

Please check the tyre data table in the WABCO diagnostic software help menu for further details. The correct Pole Wheels can be purchased from the axle manufacturer, along with WABCO wheel speed sensors.

Kit number 441 032 921 2 should be ordered which contains the sensor, locating bush and grease.

## 3 Removing the old system

– Before you remove any pipes from the existing system, label them.  
→ This will avoid problems later as some of the existing pipe work can be reused. A good selection of pipe fittings may be required to carry out the installation of the new system.

All ports on the WABCO TEBS E system are either M 16x1.5 or M 22x1.5 thread.

- Remove the old unit and all relevant pipes and cables, including the green headboard warning lamp and its cable (if fitted).
- Also at this point make a note of the location of the electrical junction box from where the TEBS E system can pick up brake light power.

## 4 Checking of all new components

The new WABCO TEBS E system comes pre-packed as a kit – part number 480 102 932 2. This kit contains all the components of a 2S/2M system (2 sensors / 2 modulators). This system is suitable for most 1-2 & 3 axle semi-trailers and also 1-2 & 3 axle centre-axle drawbar trailers.

**!** Self-steer axles: The WABCO preferred solution for trailers with a self-steer axle is to fit a 4S/3M (4 sensors / 3 modulators) system.  
If a 2S/2M or 4S/2M system is to be fitted please contact WABCO technical department for additional information.

- Unpack the system and check all components.
- Once you are satisfied that all the components are correct you can continue with the installation.

The kit should contain the following components:

Kit Content	Part Number	Quantity
TEBS E modulator with PEM (Premium) 	480 102 064 0	1
Park Release Emergency Valve (PREV) 	971 002 900 0	1
ISO 7638 supply cable (12 m) 	449 173 120 0	1
ISO 1185 (24N) cable (10 m) 	449 349 100 0	1
Sensor extension cable (2.3 m) 	449 723 023 0	2
Publication for Kit	815 010 172 3	1
TEBS E label	813 000 008 3	1
Adhesive label	899 200 922 4	1

## 5 Positioning of components for the Roll Stability Support function (RSS)

The RSS function depends on the accuracy of the parameter settings for the tyre circumference, number of pole wheel teeth and other data in the brake calculation. With inaccurate data the function will not work properly. The diagrams below show the mounting limits for the modulator to allow correct functioning of the RSS.

The RSS system detects the installation position of the modulator automatically when driving.

- Additionally you may also calibrate the installation position with the diagnostic program, for this, the vehicle must be parked on a flat, level surface (deviation from horizontal <math>< 1^\circ</math>).

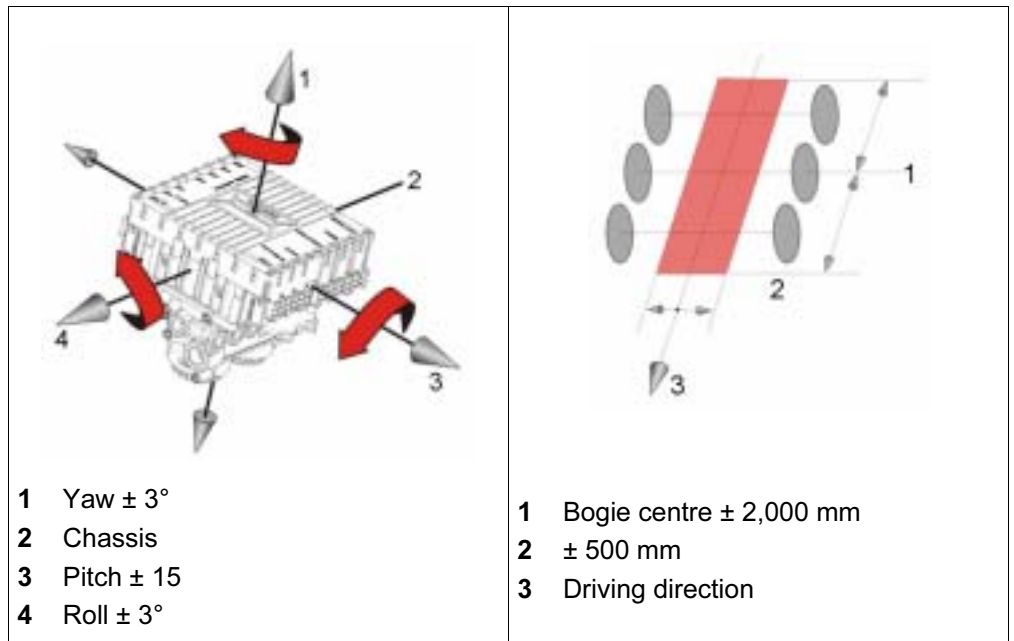

## 6 Installing the Modulator

- Fasten the Modulator to a suitable bracket (not supplied by WABCO) or chassis cross member.

If a bracket is used, it should be strong enough to support the weight of the unit, and the connected pipe work. WABCO recommend a bracket of at least 4 mm thickness.

The unit can be mounted facing forwards or backwards. This does not affect the performance of the system. The modulator position should be such that it is possible to make the brake chamber pipes all similar in length, however this need not be exact. Small variations in length are acceptable.

- Connect the pneumatic pipes and hoses. Connect first the pipes or hoses that feed the brake actuators.

It is critical to the operation of the TEBS E system that these are connected to the correct ports.

If the Modulator is mounted facing forwards the actuators on the nearside of the vehicle should be connected to ports 22 and the actuators on the offside should be connected ports 21.

If the ECU is facing towards the rear, reverse the above. These output ports are M 16x1.5 thread. Hoses, pipes and fittings with good flow characteristics should be used. The existing pipe work may be used if suitable.

## 7 Pneumatic pipe connections

The next pneumatic connection is to port 4 of the unit. The pipe that connects to port 4 is the signal pipe from the output port of the PREV (port 21) or relay emergency valve (port 2). A signal from an air suspension bellows must be connected to port 5 of the unit. This must not come from the bellows on a lifting axle.

Please refer to the detailed picture for the location of all ports and electrical connections.



- 1 Supply: PREV (Port 1-2), reservoir - braking
- 2.1 Brake actuators
- 4 Control: PREV (Port 21)
- 5 Suspension bellows pressure



- 2.2 Brake actuators



## 8 Pneumatic Extension Module (PEM)

This TEBS E kit comes complete with a PEM. This product replaces other valves which are required as part of the trailer braking system. If the PEM, TEBS E modulator and PREV are used no other valves are required for the braking system.

The valves replaced by the PEM are the anti compounding valve (double check valve) and also the charging valve. The PEM also acts as a manifold (ports 1.1), which can supply compressed air to other components on the vehicle, e.g. the auxiliary reservoir, lift axle valve etc. Output ports are also supplied for connection to the spring brake chambers (ports 2.3). If the spring brakes are connected in this manner an additional quick release valve is not required.

All ports on the PEM are either M 22x1.5, or M 16x1.5 thread.

The PEM is bolted to the TEBS E modulator at the factory. It can, however, be removed and changed individually, without the need to change the modulator.



**1(a)** Connection to reservoir, 18x2 mm diameter pipe

**1(b)** Pipe from port 1-2 of PREV

**1.1** Manifold for additional components

**2.3** Connection to spring brake chambers

**2.4** Plug or test points (brake control pressure)

**4.2** Pipe from port 22 of PREV

## 9 Electrical connections

– Connect the sensor extension cables to the ends of the sensors. It is important to connect the extension cables to the ECU at the correct channels. If your trailer has a 2 sensor system only sensor inputs ABS-c and ABS-d will be used. The positions of all the electrical inputs are marked on the top of the modulator.

If your modulator is facing forwards, the nearside (L/H) wheel sensor cable **must** go to position ABS-c, the offside (R/H) to position ABS-d. Reverse this if the modulator is facing backwards.

- To connect the sensors to the ECU, prise the yellow retaining clip outwards, by approximately 12 mm.
- Then locate the sensor plug in the socket and push it upwards.
- Once the sensor plug is in place, push the clip inwards to secure the plug. The ECU has two sensor connections for each side of the vehicle.

**CAUTION** Damage of ECU

- On a 2S/2M system sensors e and f will be blanked off. It is important that these blanking plugs are left in place. Failure to observe this may cause water to enter the ECU, invalidating the warranty.

If a SmartBoard is to be fitted, the cable should be connected to the socket SUBSYSTEMS.

If an external component is required e.g. a lift axle valve, or RTR valve, an additional cable can be purchased and connected to one of the GIO ports.



Please contact WABCO technical for details.

- An ISO 7638 power cable is provided in the kit. Route it carefully along the chassis and connect to the ECU at the socket marked POWER.
- When making this connection it is important that the cable is not pulled tight, causing stress, at the connection. A small length of excess cable will help to avoid this. A bracket is provided on the modulator, to which the power cable can be secured with a cable tie.
- Connect the 24N cable (449 349 100 0) to the input marked IN/OUT.
  - From this cable, connect the blue wire to pin 4 (brake lamp feed) of the 24N, and the brown wire to pin1 (ground).

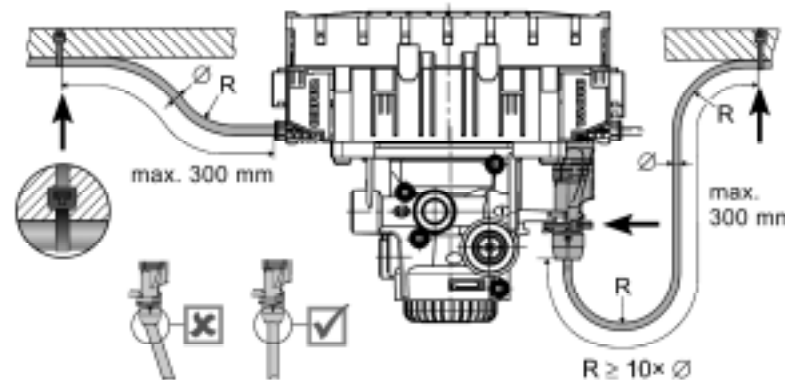

## 10 Fitting a Park Release Emergency Valve (PREV)

The PREV valve recommended by WABCO is 971 002 900 0.

The valve has five ports – all the ports are M 16x1.5 thread and are connected as follows:

- Port 1 - Energy supply. This pipe comes from the red coupling (emergency).

- Port 21 - This is the output from the PREV and feeds air to Port 4 of the EBS modulator.
- Port 22 – This pipe goes to port 42 of the PEM.
- Port 1-2 - This pipe feeds port 1 of the PEM.
- Port 4 - The pipe connected to this port comes from the yellow coupling (service) diameter.

After connecting all pipes to the PREV, the system can be charged with air.

- Check for leaks and correct function.
- Test the operation of the PREV by disconnecting the red coupling and checking that the service brakes apply.
- Also check correct operation of shunt button.

## 11 Commissioning

- Use WABCO diagnostic software for programming the system. Enter the data from brake calculation, along with other parameters, and a sign off test carried out.
- Power up the system, using ISO 7638 power.
- ➔ After a few seconds four clicks will be heard from the modulator – this is the system checking itself. The dashboard warning lamp will come on with the ignition switch and will go out after the vehicle has moved at more than 7kph. This is to check the function of the wheel speed sensors. When the system is next powered up, and every time thereafter, the lamp will go out after approximately two seconds and will only come back on if a fault occurs.

The system must now be tested using the alternative power supply (24N).

- Disconnect the ISO 7638 cable.
- Depress the footbrake.
- Then switch on the ignition.
- ➔ The self check clicks will be heard.



For additional information on WABCO Trailer EBS E and its functions please request a free copy of brochure 815 000 420 3 from WABCO technical.

## 12 Approval of system

After installation and checking of the system the VTG10 form must be completed and the Vehicle & Operator Services Agency (VOSA) informed to make sure the installation is correct.

This can be done two ways:

1. If the customer has the appropriate WABCO diagnostic software and has completed a official TEBS E WABCO training course, and has a License Letter giving them access to a PIN number then they can sign off the system themselves, then once the installation is complete, It will produce a system sign off certificate. This is evidence of a successful installation of the EBS system.

– Attach the certificate to the VTG10 form and send it to VOSA.

2. If diagnostic software is not available, then contact WABCO technical for a list of approved WABCO service centres.

– Contact your nearest service centre who will travel to your vehicle and sign off the EBS system.

The customer will be issued with a sign off certificate which can be attached to the VTG10 and sent to VOSA.

Form VTG10 can be obtained from VOSA - see annex.

13 Annex

Questionnaire for Trailers fitted with EBS



# Questionnaire for trailers fitted with TEBS

Submit by Email

Reset Form

Print Form

Trailer Manufacturer

Trailer Model

Chassis Number(s)



TEBS-D



TEBS-E

comments:

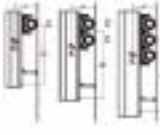
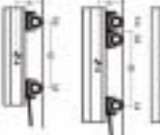
	laden		unladen
<b>centre axle trailer</b>	maximum mass	P kg	
	axle load - axle 1	P1 kg	
	axle load - axle 2	P2 kg	
	axle load - axle 3	P3 kg	
	suspension pressure	Sp bar	
<b>semi-trailer</b>	maximum mass	P kg	
	axle load - axle 1	P1 kg	
	axle load - axle 2	P2 kg	
	axle load - axle 3	P3 kg	
	axle load - axle 4	P4 kg	
	axle load - axle 5	P5 kg	
	C of G height	h m	
	wheelbase	Er m	max
	suspension pressure	Sp bar	
<b>full trailer</b>	maximum mass	P kg	
	axle load - axle 1	P1 kg	
	axle load - axle 2	P2 kg	
	axle load - axle 3	P3 kg	
	axle load - axle 4	P4 kg	
	axle load - axle 5	P5 kg	
	C of G height	h m	
	wheelbase	Er m	max
	suspension pressure	Sp bar	

	disc or drum?				
axle	1	2	3	4	5
Actuator size					
cam lever length	mm				
brake factor					
threshold torque	Nm				
tyre size					
brake manufacturer					
brake reference					
brake approval number					

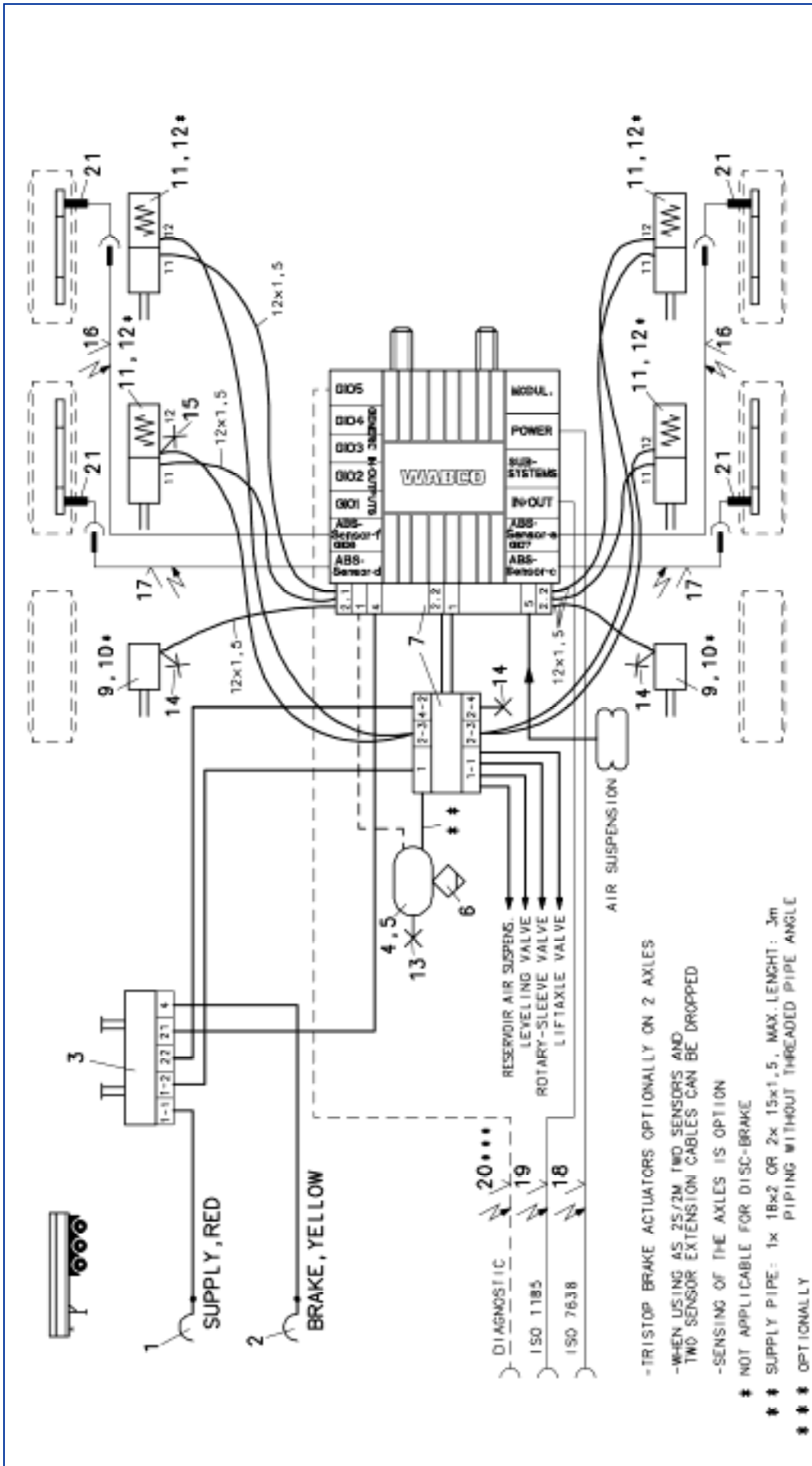

-TRISTOP BRAKE ACTUATORS OPTIONALLY ON 2 AXLES  
 -WHEN USING AS 25/2M TWO SENSORS AND TWO SENSOR EXTENSION CABLES CAN BE DROPPED  
 -SENSING OF THE AXLES IS OPTION  
 \* NOT APPLICABLE FOR DISC-BRAKE  
 \*\* SUPPLY PIPE: 1x 18x2 OR 2x 15x1.5, MAX. LENGTH: 3m  
 PIPING WITHOUT THREADED PIPE ANGLE  
 \*\*\* OPTIONALLY

DATE		SIGNATURE		<b>WABCO</b>	
08-12-04		AP17HY		TRAILER - EBS E	
06-12-04		GRUSSK		FOR 3-AXLES-SEMITRAILER	
STANDARDIZATION		45/2M DR 25/2M		-WITH EXTENSION MODUL-	
T.B.1.		PRODUCT IDENTIFICATION NO.		BOOK FOR DOCUMENT SHEET	
171		841 701 110 0		402 01	
A 3		CODE FOR FUNCTION		REV. OR IMP.	
3124		REV. OR IMP.		DATE	
13	1	TEST CONNECTION	463 703 115 0		
12	4	K11	423 903 532 2		
11	4	TRISTOP BRAKE ACT.	925 .....		
10	2	K11	423 000 ... 2		
9	2	BRAKE CHAMBER	423 10 ... 0		
8	..	..	480 102 ... 0	21	4
7	1	TRAIL -MODULATOR W. EXTENSION MOD.	934 300 001 019	1	24N-CABLE
6	1	DRAIN VALVE	451 999 ... 218	1	SUPPLY(POWER)-CABLE
5	2	HOSE CLAMP	950 .....	017	2
4	1	AIR RESERVOIR	871 001 8... 016	2	EXTENSION CABLE FOR SENSOR
3	1	PARK-RELEASE-EMERG.- VALVE (PREV)	942 201 003 015	1	TEST CONNECTION
2	1	COUPLING HEAD W. INT. LINE FILTER	952 201 002 014	3	TEST CONNECTION
1	1	COUPLING HEAD W. INT. LINE FILTER	952 201 002 014	3	TEST CONNECTION









WABCO Vehicle Control Systems is one of the world's leading providers of electronic braking, stability, suspension and transmission automation systems for heavy duty commercial vehicles. Customers include the world's leading commercial truck, trailer, and bus manufacturers. Founded in the U.S. in 1869 as Westinghouse Air Brake Company, WABCO was acquired by American

Standard in 1968 and spun off in 2007. Headquartered in Brussels, Belgium, WABCO employs more than 7,700 people in 31 countries worldwide. In 2007, WABCO's total sales were \$2.4 billion. WABCO is a publicly traded company and is listed on the New York Stock Exchange with the stock symbol WBC.

**[www.wabco-auto.com](http://www.wabco-auto.com)**



**WABCO**