



Valvola controllo asse sollevabile (LACV II)



463 084 031 0
463 084 041 0 con raccordi a innesto rapido

Valvola livellatrice



464 006 002 0
464 006 100 0 con fine corsa integrato
464 006 102 0 con raccordi a innesto rapido

Leveraggio
433 401 003 0

Giunto d'accoppiamento pneumatico con filtro di linee integrato

automatico
952 201 012 0
952 201 015 0 con raccordi a innesto rapido

Moderabile
952 201 011 0
952 201 014 0 con raccordi a innesto rapido + raccordo di prova

Valvola relè di emergenza e parcheggio (PREV)

Numero del prodotto	raccordi a innesto rapido	Targhetta	Raccordo di prova
971 002 900 0	X	✓	X
971 002 902 0	X	X	X
971 002 910 0	✓	X	X
971 002 911 0	✓	X	X
971 002 912 0	✓	✓	✓

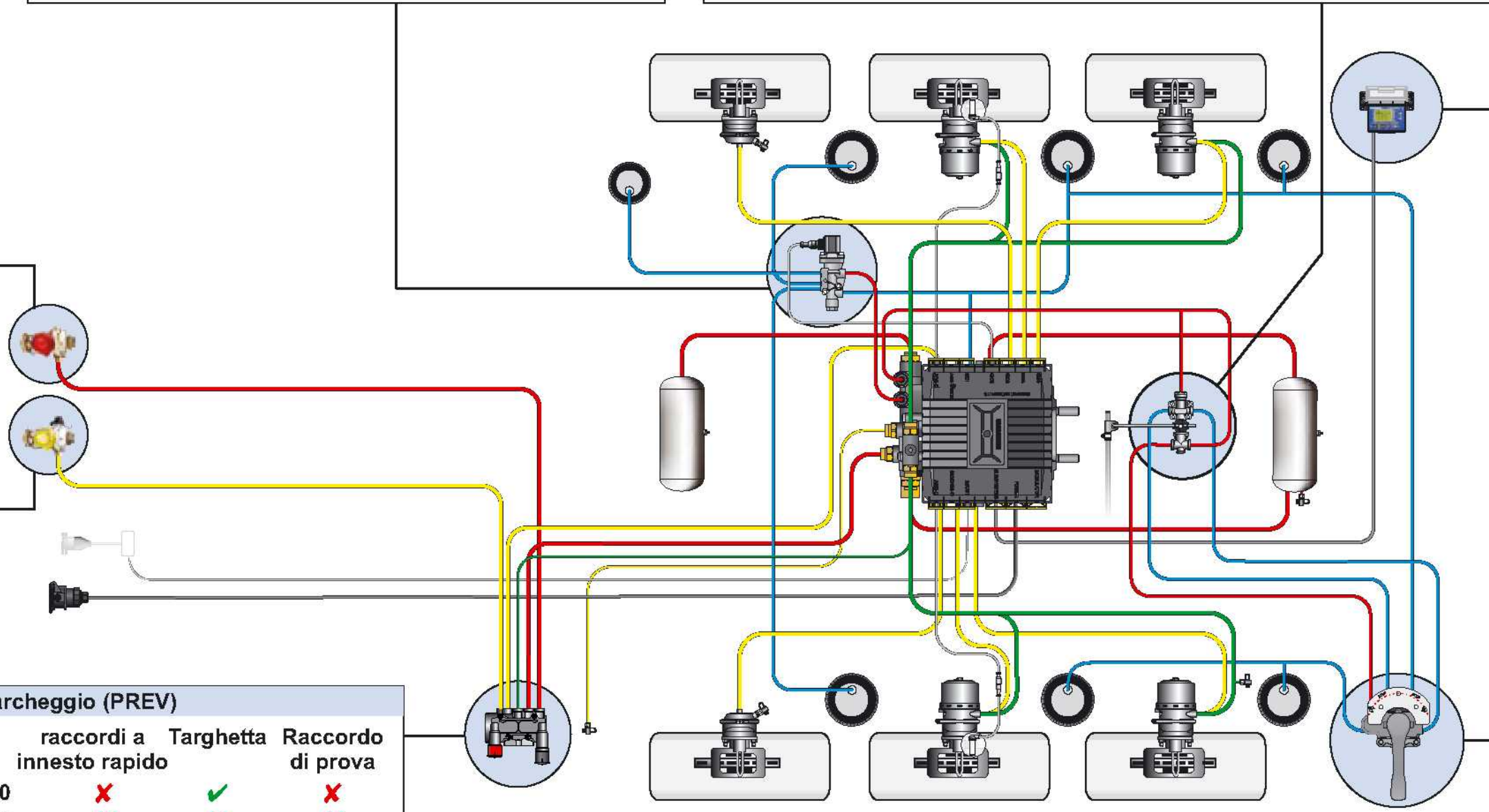

Sistema di rilevamento informazioni



SmartBoard
446 192 110 0

Sistema di controllo delle sospensioni



Rubinetto a cassetto rotativo
463 032 020 0
463 032 220 0 con raccordi a innesto rapido

Standard con sospensione ad aria convenzionale

Modulatore Trailer EBS E	Numero del Prodotto	Sistema	Supporto sospens. mech.	Controllo sospens. pneum. integrata	Numero di GIOs	PEM	Raccordi a innesto rapido	Dimensioni del tubo automatico	Sosp. pneum.
 con PEM (Pneumatic Extension Module)	480 102 030 0	Standard, 2S/2M	X	X	4	X	X		
	480 102 031 0	Standard, 2S/2M	X	X	4	✓	✓	∅ 16 x 2	∅ 8 x 1
	480 102 032 0	Standard, 2S/2M	X	X	4	X	✓		
	480 102 033 0	Standard, 2S/2M	X	X	4	✓	✓	∅ 15 x 1.5	∅ 12 x 1.5
	480 102 034 0	Standard, 2S/2M	X	X	4	✓	X		
	480 102 060 0	Premium, max 4S/3M	✓	✓	7	X	X		
	480 102 061 0	Premium, max 4S/3M	✓	✓	7	✓	✓	∅ 16 x 2	∅ 8 x 1
	480 102 062 0	Premium, max 4S/3M	✓	✓	7	X	✓		
	480 102 063 0	Premium, max 4S/3M	✓	✓	7	✓	✓	∅ 15 x 1.5	∅ 12 x 1.5
	480 102 064 0	Premium, max 4S/3M	✓	✓	7	✓	X		

Diagnosi del Trailer EBS E

 Interfaccia di diagnosi con porta USB 446 301 022 0	 Cavo di diagnosi 446 300 361 0	 Adattatore per connessione a presa ISO 7638 con attacco CAN 446 300 360 0
Opzione 2  Interfaccia di diagnosi con porta seriale 446 301 021 0	 Convertitore CAN 446 300 470 0	 Adattatore per connessione a presa ISO 7638 con attacco CAN 446 300 360 0
Opzione 3  Interfaccia di diagnosi USB o seriale	 Cavo di diagnosi 446 300 348 0	 Presa di diagnosi con cappuccio giallo (Solo ECU Premium) 449 611 ... 0

Premium con sospensione pneumatica elettronica

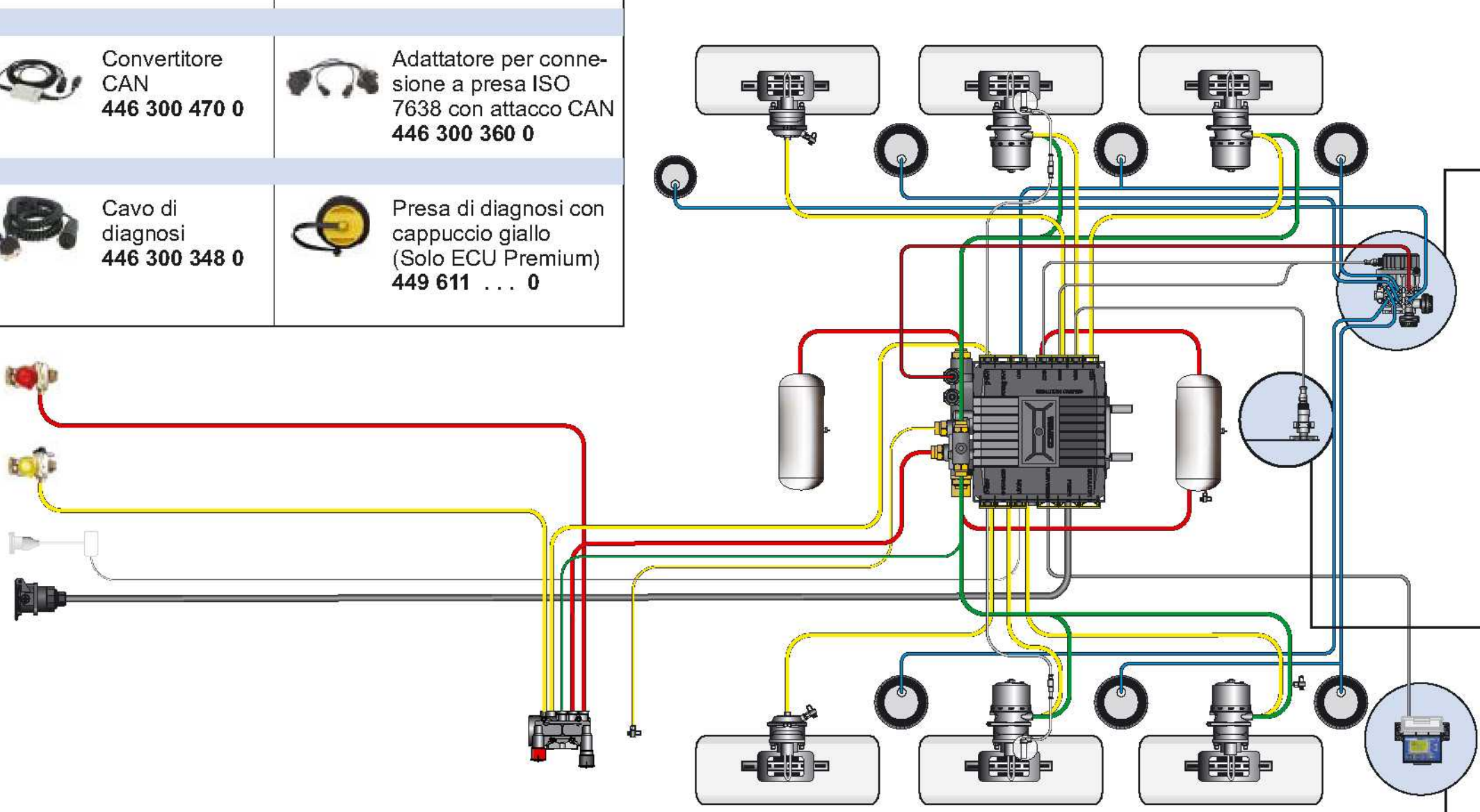

Elettrovalvola ECAS



472 880 030 0 con controllo assale



472 905 114 0 con controllo assale + asse sollev.

Sensore ECAS



Sensore d'altezza
441 050 100 0



Asta
441 050 718 2



Leveraggio
433 401 003 0

Controllo della sospensione



Telecomando
446 056 25 . 0
controllo Trattore/motrice e rimorchiato - da cabina - necessita centralina WABCO CAN2



Pulsantiera di controllo ECAS
446 156 010 0 con controllo assale
446 156 011 0 con controllo assale + asse sollev.



Telecomando ECAS
446 056 116 0 con controllo assale
446 056 117 0 con controllo assale + asse sollev.



SmartBoard
446 192 110 0

© 2007 WABCO. All Rights reserved. 815 050 143 3 / 07.2007