

Handbremsventil

Hand Brake Valve

961 702

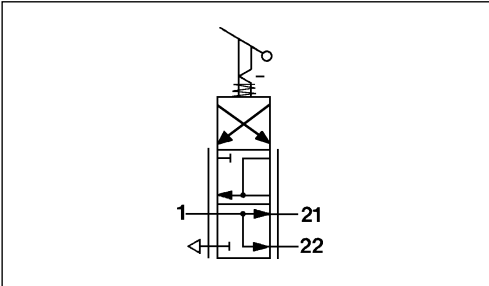
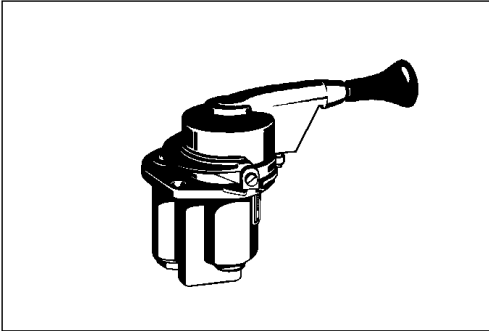

Technische Daten / Technical Data:

Betriebsdruck Operating pressure	max. 8 bar	
Zulässiges Medium Permissible medium	Luft / air	
Therm. Anwendungsbereich Operating temperature range	siehe Tabelle see table	
Nennweite Nominal diameter	Anschluß 21 Port 21	Ø 8 mm
	Anschluß 22 Port 22	Ø 5 mm

Einbaumaße / Installation:

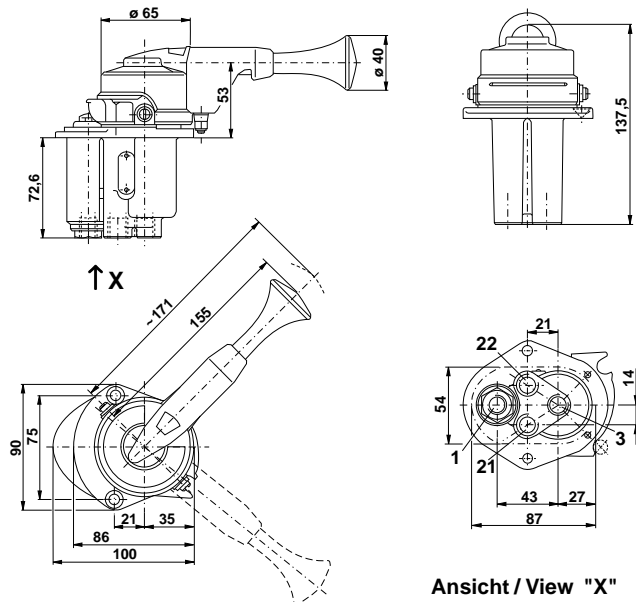

Ansicht / View "X"

Anschlüsse / Ports:

- | | | |
|------|----------|---|
| 1 = | M 14x1,5 | Energiezufuß / Energy supply |
| 21 = | M 14x1,5 | Federspeicher / Spring brake actuator |
| 22 = | M 14x1,5 | Anhänger-Steuerventil / Trailer control valve |
| 3 = | M 14x1,5 | Entlüftung / Exhaust |

Zweck:

Feinfühlig abstufbare Betätigung der Hilfsbremse sowie Betätigung der Feststellbremse in Verbindung mit Federspeicherzylindern.

Einbauempfehlung:

Das Handbremsventil ist mit 2 Senkschrauben M6 im Armaturenbrett zu befestigen.

Purpose:

Sensitive graduated operation of the auxiliary brake and operation of the parking brake in conjunction with spring brake actuator.

Installation Requirement:

The hand brake valve should be mounted on a panel with two M6 countersunk screws.

Handbremsventil

Hand Brake Valve











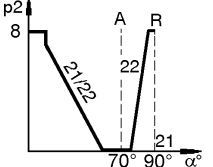
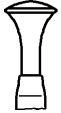
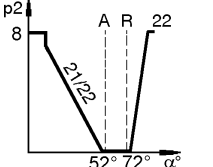

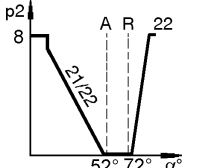
961 702

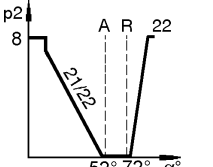
Erläuterungen / Explanations:

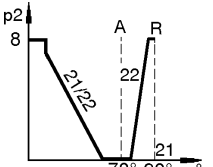
Betätigungsbereich / Operating range:

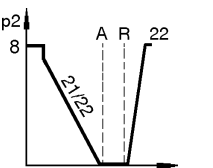
A= Anschlag / Stop

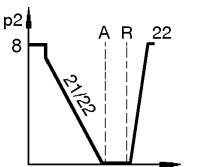
R= Raststellung / Locked position





Bestellnummer Part Number	Charakteristik und Drehrichtung Characteristic and direction of rotation	Griffform Handle	Thermischer Anwendungsbereich Operating temperature range	Bemerkungen Comments
961 702 001 0	 <p>rechtsdrehend / clockwise</p>		-40°C bis/to +80°C	
961 702 004 0	 <p>rechtsdrehend / clockwise</p>		-10°C bis/to +120°C	
961 702 005 0	 <p>rechtsdrehend / clockwise</p>		-40°C bis/to +80°C	
961 702 006 0	 <p>rechtsdrehend / clockwise</p>		-10°C bis/to +120°C	
961 702 011 0	 <p>linksdrehend / anti-clockwise</p>		-40°C bis/to +80°C	
961 702 014 0	 <p>linksdrehend / anti-clockwise</p>		-10°C bis/to +120°C	
961 702 015 0	 <p>linksdrehend / anti-clockwise</p>		-40°C bis/to +80°C	

Erläuterungen / Explanations:

Betätigungsbereich / Operating range:

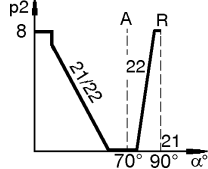
A= Anschlag / Stop

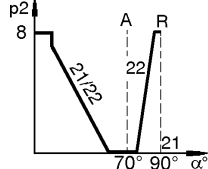
R= Raststellung / Locked position

Bestellnummer Part Number	Charakteristik und Drehrichtung Characteristic and direction of rotation	Griffform Handle	Thermischer Anwendungsbereich Operating temperature range	Bemerkungen Comments
961 702 030 0	 <p>rechtsdrehend / clockwise</p>		-10°C bis/to +120°C	
961 702 031 0	 <p>linksdrehend / anti-clockwise</p>		-40°C bis/to +80°C	