

Tristop® - Zylinder

Tristop® - Brake Actuator

925 371

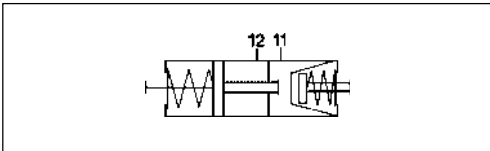
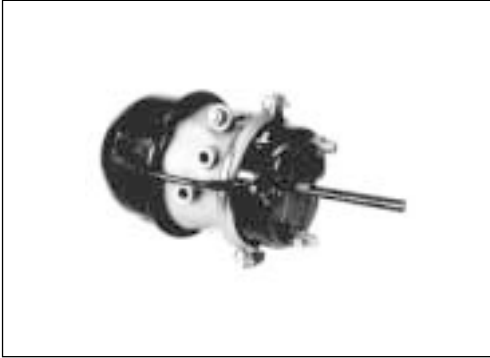

Zweck und Einbauanleitung:
Siehe 925 320

Purpose and Installation Requirement:
See 925 320

Technische Daten / Technical Data:		
Bestellnummer Part Number	ohne Gabelgelenk without yoke	925 371 300 0
	mit Gabelgelenk with yoke	925 371 307 0
Type	24 / 30	
Betriebsdruck Operating Pressure	8,5 bar	
Zulässiges Medium Permissible Medium	Luft / air	
Therm. Anwendungsbereich Operating temperature range	-40°C bis/to +80°C	
Gesamthub Overall stroke	Membranzylinder Brake chamber	75 mm
	Federspeicherzylinder Spring brake actuator	75 mm
Druckstangenauslenkung Piston rod deflection	allseitig max. 3° 3° max. all round	
Gewinde der Leitungsanschlüsse Thread of pipe connection	M16x1,5	

Einbaumaße / Installation:

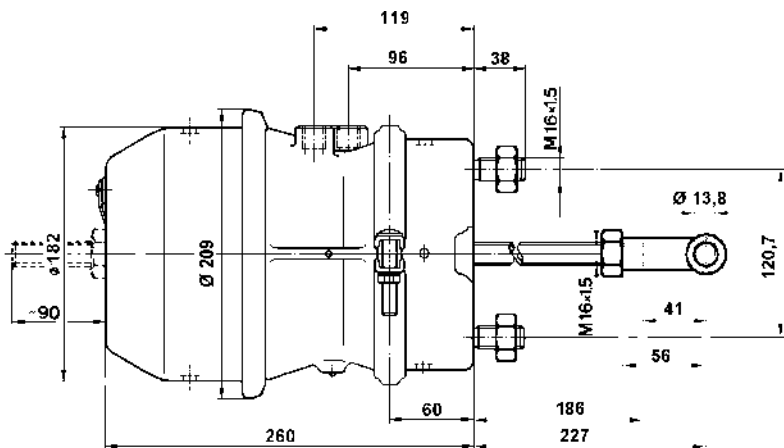
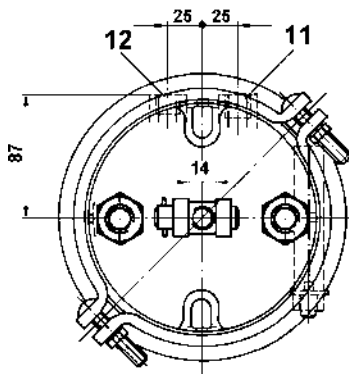

Charakteristik / Characteristic:

Kraftabgabe der Betriebsbremse
Output force of service brake
bei/at 6,5 bar

Kraftabgabe des Federspeichers
Lösedruck 4,6 bar
Output force of spring brake
Release Pressure 4,6 bar

Rückstellfederkraft des Betriebs
bremsteiles
Force of return spring of service
brake part

