



Zweck:

Das Magnetventil dient zur Ansteuerung von pneumatischen Komponenten in Nutzfahrzeugen und Bussen.

Einbauempfehlung:

Das Magnetventil wird je nach Bauart mit 2 bzw 4 Schrauben M8 befestigt.

Purpose:

The solenoid valve is used to actuate pneumatic components in commercial vehicles and buses

Installation Requirements:

Depending on the variant used, these solenoid control valves are fastened with 2 or 4 screws M8.

Technische Daten / Technical Data:

Betriebsdruck Operating pressure	max. 10 bar
Zulässiges Medium Permissible medium	Luft / air
Thermischer Anwendungsbereich Operating temperature range	siehe Tabelle see table
	I = -40°C bis/to +100°C II = -40°C bis/to +70°C III = -20°C bis/to +70°C IV = -40°C bis/to +80°C V = -20°C bis/to +80°C VI = -40°C bis/to +65°C
Betriebsart Operation	siehe Tabelle see table
Stromart Current	Gleichstrom D.C.
Anschlüsse Ports	M 12x1,5*

*) Abweichungen siehe Bemerkungen

*) For deviations see table



**Lage der Anschlüsse 1 und 3:
Position of ports 1 and 3:**

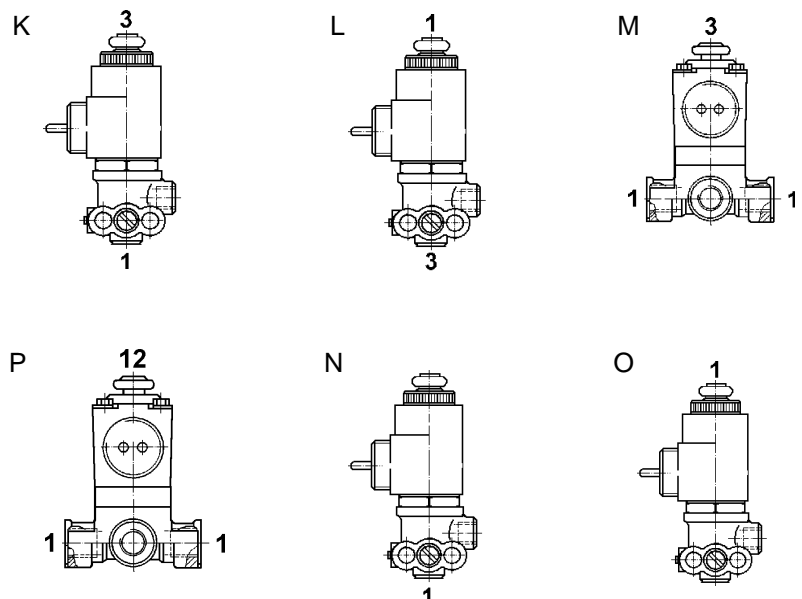

Magnetventil

Solenoid Valve

472 ...

Symbol:

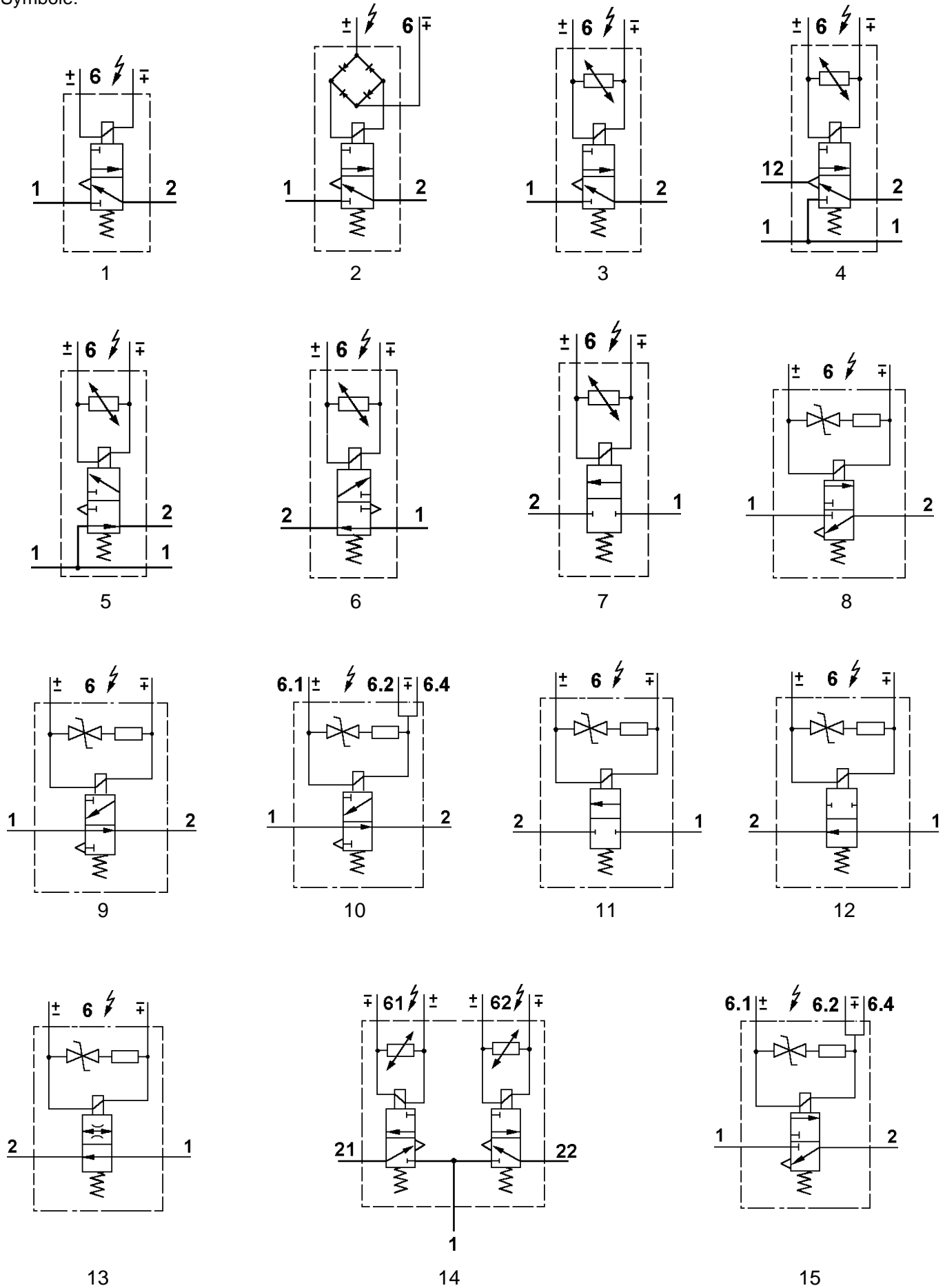

Magnetventil

Solenoid Valve

472 ...

TYPE (Magnetstellung / Position of Solenoid):

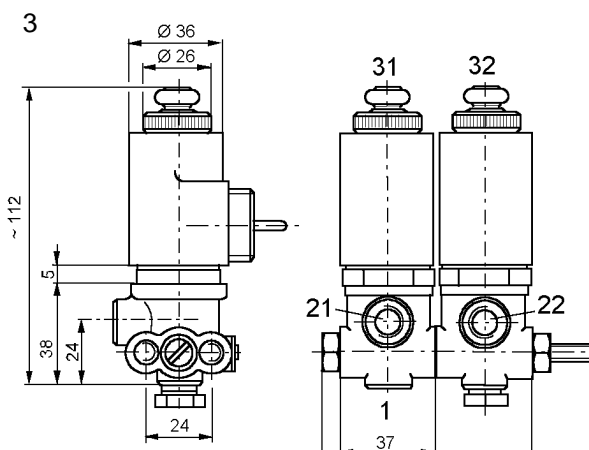
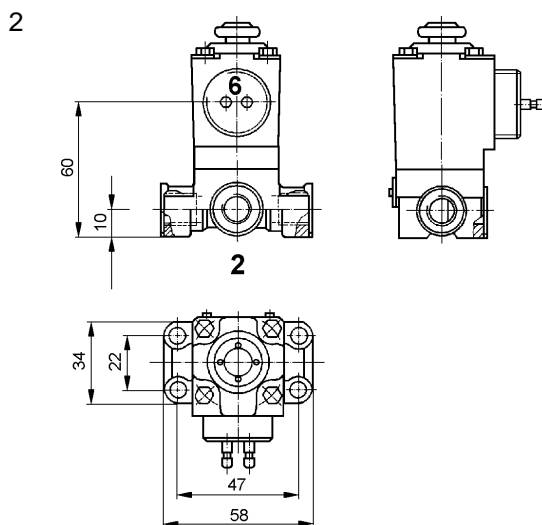
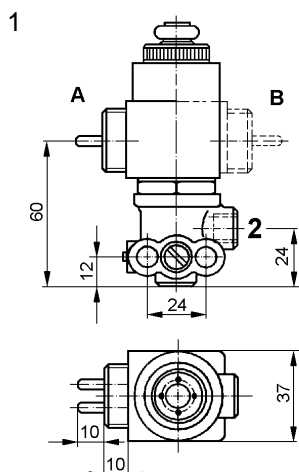

Anschlüsse / Ports:

- 1 = Energiezufuß / Energy supply
- 2 = Energieabfluß / Energy delivery
- 6(4) = Elt. Steueranschluß / Electrical Control
- 61 (41) = Elt. Steueranschluß / Electrical Control
- 62 (42) = Elt. Steueranschluß / Electrical Control
- 63 (43) = Elt. Steueranschluß / Electrical Control
- 64 (44) = Elt. Steueranschluß / Electrical Control

Alte Anschlußbezeichnungen in Klammern
Old port markings in brackets

4

Elektrischer Steueranschluß 6: Electrical Control Port 6:

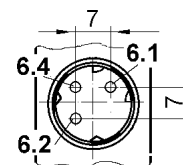
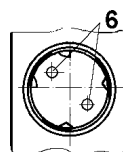
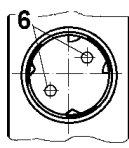
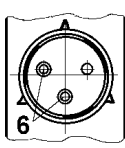
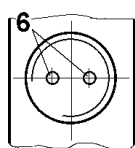

M 24x1
M 27x1

Ba
Bajonett
Bayonet

Bajonett / Bayonet
DIN 72585-A1-2.1-Sn/k1

Bajonett / Bayonet
DIN 72585-A1-2.1-Sn/k2

Bajonett / Bayonet
DIN 72585-A1-3.2-Sn/k1

Detail:

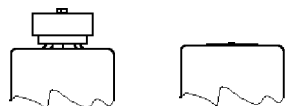

S

S1

M 12x1,5 (innen/internal)

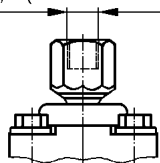

T

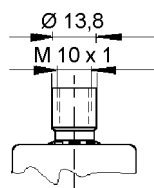

V

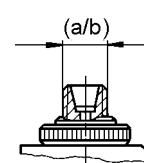

Y

Ya = M 12x1,5 Ø 6
Yb = M 14x1,5 Ø 8

Magnetventil

Solenoid Valve

472 ...

Bestellnummer Part Number	Ersatzgerät Replaced by	Type	Anschlußlage Position of ports	Detail	Anschluß 6 Port 6	Nennspannung Voltage V	Nennweite Nominal Diameter Ø mm	Nennstrom Rated Current mA	Betr. Druck Oper. Pressure bar	Therm. Anw. Bereich Oper. temp. range	Symbol	ED %
472 070 628 0	-	1.B	K	S	3.2 Sn/K1	24	4/4	690	13	IV	15	100
472 070 639 0 2)	-	1.B	K	S	2.1 Sn/K2	24	4/4	690	13	IV	8	100
472 072 628 0	-	1.B	K	S	3.2 Sn/K1	24	2,2/3	410	12,5	I	15	100
472 072 639 0 2)	-	1.B	K	S	2.1 Sn/K2	24	2,2/3	410	13	IV	8	100
472 106 108 0	-	2	M	-	M27x1	24	2/2	320	10	I	5	100
472 111 708 0	-	2	P	T	M27x1	24	2/2	320	8,5	I	4	100
472 123 107 0	-	1.A	K	-	M 27x1	12	2,2/3	860	10	I	3	100
472 123 108 0	472 172 600 0	1.A	K	-	M 27x1	24	2,2/3	430	10	I	3	100
472 123 112 0	-	1.A	K	-	M 24x1	24	2,2/3	430	10	I	1	100
472 123 198 0	-	1.B	K	-	M 27x1	24	2,2/3	430	10	I	3	100
472 123 706 0	-	1.B	K	-	M 27x1	24	2,2/3	480	10	I	2	100
472 124 108 0	472 170 600 0	1.A	K	-	M 27x1	24	4/4	650	10	III	3	100
472 125 707 0	-	1.A	L	Ya	M 27x1	12	4/4	1300	8	III	6	100
472 125 708 0	472 173 700 0	1.A	L	Ya	M 27x1	24	4/4	650	8	III	6	100
472 126 108 0	472 170 600 0	1.A	K	-	M 27x1	24	4/4	650	11	II	3	30
472 126 708 0	472 170 700 0	1.A	K	Ya	M 27x1	24	4/4	650	10	V	3	30
472 128 758 0	472 171 704 0	1.A	L	Ya	Ba	24	2,2/2,2	430	10	I	6	100
472 128 908 0	472 171 000 0 472 171 700 0	1.A	L	Yb	M 27x1	24	2,2/2,2	430	10	I	6	100
472 132 158 0	472 172 604 0 472 172 704 0	1.A	K	-	Ba	24	2,2/3	430	10	I	3	100
472 132 198 0	-	1.B	K	-	Ba	24	2,2/3	430	10	I	3	100
472 133 158 0	472 170 604 0	1.A	K	-	Ba	24	4/4	650	11	II	3	100
472 137 132 0	-	1.A	K	Volvo		24	4/4	1600	11	IV	1	30
472 160 708 0	-	1.A	K	Yb	M 27x1	24	1,2/2,2	430	13	VI	3	100
472 162 108 0	-	1.A	K	-	M 27x1	24	2,5/3	650	13	VI	3	100
472 162 508 0	472 174 500 0	1.A	N	-	M 27x1	24	2,5	650	13	II	7	100
472 162 558 0	472 174 504 0	1.A	N	-	Ba	24	2,5	1300	13	II	7	100
472 164 758 0	472 173 204 0	1.A	L	T	Ba	24	3/3	650	11	IV	6	30
472 166 158 0	472 170 604 0	1.A	K	-	Ba	24	4/4	650	11	IV	3	30
472 166 558 0	472 174 504 0	1.A	N	-	Ba	24	4	1600	13	VI	7	30

Bestellnummer Part Number	Ersatzgerät Replaced by	Type	Anschlußlage Position of ports	Detail	Anschluß 6 Port 6	Nennspannung Voltage V	Nennweite Nominal Diameter Ø mm	Nennstrom Rated Current mA	Betr. Druck Oper. Pressure bar	Therm. Anw. Bereich Oper. temp. range	Symbol	ED %
472 170 600 0	-	1.A	K	S	M 27x1	24	4/4	690	13	IV	8	100
472 170 604 0	-	1.A	K	S	Ba	24	4/4	690	13	IV	8	100
472 170 700 0	-	1.A	K	Ya	M 27x1	24	4/4	690	13	IV	8	100
472 171 000 0	-	1.A	L	Yb	M 27x1	24	2,2/2,2	410	13	I	9	100
472 171 428 0	-	1.B	L	V	3.2-Sn/k1	24	2,2/2,2	410	13	I	10	100
472 171 700 0	-	1.A	L	Ya	M 27x1	24	2,2/2,2	410	13	I	9	100
472 171 704 0	-	1.A	L	Ya	Ba	24	2,2/2,2	410	16	I	9	100
472 171 726 0	-	1.B	L	Ya	2.1-Sn/k1	24	2,2/2,2	410	16	I	9	100
472 172 600 0	-	1.A	K	S	M 27x1	24	2,2/3	410	12,5	I	8	100
472 172 604 0	-	1.A	K	S	Ba	24	2,2/3	410	12,5	I	8	100
472 172 626 0	-	1.B	K	S	2.1-Sn/k1	24	2,2/3	410	12,5	I	8	100
472 172 704 0	-	1.A	L	Ya	Ba	24	2,2/3	410	12,5	I	8	100
472 172 724 0	-	1.B	K	Ya	Ba	24	2,2/3	410	12,5	II	8	100
472 172 726 0	-	1.B	K	Ya	2.1-Sn/k1	24	2,2/2,2	410	12,5	I	8	100
472 172 784 0	-	1.A*	K	Ya	Ba	24	2,2/2,2	410	12,5	I	8	100
472 173 204 0	-	1.A	L	T	Ba	24	4/4	690	13	IV	9	100
472 173 428 0	-	1.B	L	V	3.2-Sn/k1	24	4/4	690	13	IV	10	100
472 173 700 0	-	1.A	L	Ya	M 27x1	24	4/4	690	13	IV	9	100
472 173 704 0	-	1.A	L	Ya	Ba	24	4/4	690	13	IV	9	100
472 174 500 0	-	1.A	N	S1	M 27x1	24	4	690	13	IV	11	100
472 174 504 0	-	1.A	N	S1	Ba	24	4	690	13	IV	11	100
472 174 524 0	-	1.B	N	S1	Ba	24	4	690	13	IV	11	100
472 175 424 0	-	1.B	O	V	Ba	24	4	690	16	IV	12	100
472 175 494 0	-	1.B	O	V	Ba	24	**)	690	16	IV	13	100
472 175 794 0	-	1.B	O	Ya	Ba	24	**)	690	16	IV	13	100
472 223 108 0	-	3	K	-	M 27x1	24	2,2	430	10	IV	14	100
472 124 108 0	-	3	K	-	M 27x1	24	4	650	10	III	14	100

2) Anschlüsse / Ports M 16x1,5 f. Voss

*) Magnet um 90° gedreht / Solenoid turned by 90°

***) Ø4 = ungedrosselte Stellung, Ø 0,4 = gedrosselte Stellung

***) Ø4 = unthrottled position, Ø 0,4 = throttled position