

# Einzylinder-Kompressor

## Single Cylinder Air Compressor

# 411 053

# 1

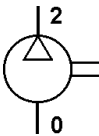
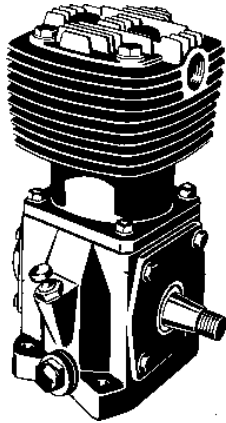

### Technische Daten / Technical Data:

Type	NDR
Bohrung Bore	Ø 90 mm
Hub Stroke	46 mm
Hubvolumen Swept volume	293 cm <sup>3</sup>
Betriebsdruck Operating pressure	max. 8 bar
Kühlung Cooling	Luft air
Betriebsdrehzahl Normal speed	max. 2800 U/min
Schmierart Type of lubrication	TH
Gewicht Weight	14,0 kg

### Zweck:

Erzeugung von Druckluft in Fahrzeugen.

### Einbauempfehlung:

siehe Broschüre 826 001 099 3

### Purpose:

To generate compressed air in vehicles.

### Installation Requirement:

see brochure 826 001 099 3

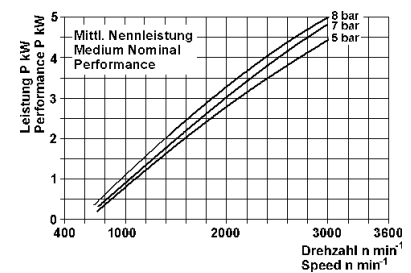
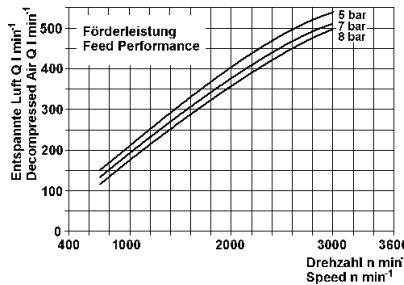

### Einbaumaße / Installation:

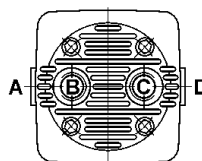
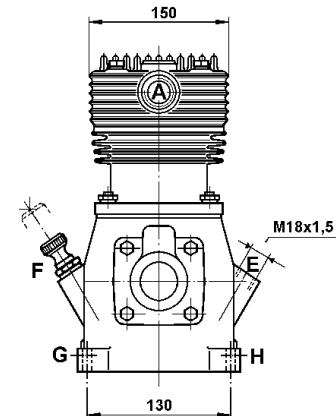
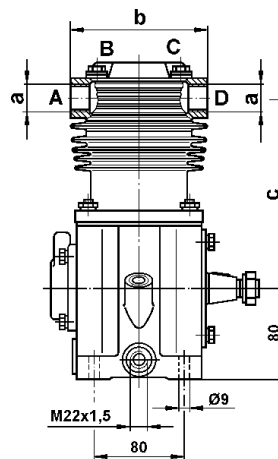

Bestellnummer Part Number	Anschlüsse / Ports								Maße / Dimensions			Bemerkungen Comments
	A	B	C	D	E	F	G	H	a	b	c	
411 053 000 0	0	-	-	2	8	8*	82*	82*	M 26x1,5	150	174	

\* mit Stopfen verschlossen / closed with plug