

ELM

Electronic Levelling Module 474 100 001 0
Operating Instructions



WABCO



Operating Instructions

**Electronic Levelling Module (ELM)
474 100 001 0**



Version: June 2001

This publication is not subject to any update service.
New versions are available in INFORM at
www.wabco-auto.com



© Copyright WABCO 2001

WABCO

Vehicle Control Systems

The right of amendment is reserved.

Version 06.2001(en)

815 010 040 3

General

The Electronic Levelling Module (ELM) 474 100 001 0 was developed for commercial vehicles – especially for Semi-Trailers.

An air suspension system equipped with an ELM has functions superior to a conventional air suspension system:

- Control of ride height while the vehicle is moving.
- Raising and lowering of the superstructure while the vehicle is standing still via a control unit so that loading and unloading operations are made easier.

The following functions are also available:

- Regulation of the superstructure height over the axle while the vehicle is moving only in relatively long time intervals (60 s), as consequence of undesired disturbances.
- Automatic control in normal level, and blocking of commands from the remote control unit, when an input speed limit has been exceeded (20 km/h).
- Control of any desired level in loading and unloading mode, selected by raising or lowering.
- Storing and requesting two preferred levels via the remote control unit (memory function).
- Termination of height changes by releasing the control button.

In order to fully utilise the capacity of the ELM and to put the system into operation, a remote control unit, like the one employed in ECAS systems must be used (preferably 446 056 116 0).

Module assemblies and interfaces

The following assemblies are integrated into ELM:

- A height sensor with lever for determining the distance between chassis and axle.
 - Electronics ...
 - ... for monitoring and converting the incoming height sensor signals
 - ... to the desired value required by energising solenoid valves and from saved data (calibration levels, memory levels).
 - 2 solenoid valves for accentuating the air suspension carrier bellows, whereby a 3/2-way valve carries out inflating and de-flating and a 2/2-way valve blocks/opens the connections to the connected air suspension bellows.
- ELM has 4 pneumatic and 2 electrical connections and a mechanical connection. These mean individually:
- Pneumatic connection 1: inlet of the pneumatic supply line from the air reservoir to the air suspension system.
 - Pneumatic connection 2.1: output to the air suspension bellows of the right side of the vehicle.

- Pneumatic connection 2.2: output to the air suspension bellows on the left side of the vehicle.
- Pneumatic connection 3: Bellow exhaust.
- Electrical connection 6.1 - "POWER/SIGNAL": connection of cable coming from VCS or EBS to the voltage supply and to receive data (speed), as well as output of information to an info-master.
- Electrical connection 6.2 - "REMOTE CONTROL": connection of the control unit cable.
- Mechanical connection: connecting rod from the axle to determining the distance between axle - frame.

Installation

Installing onto vehicles

The Electronic Levelling Module (ELM) is installed onto the vehicle frame over the axles. The installation location corresponds to that of the air suspension valve in conventional air suspension systems. Short pneumatic lines make

possible quick reaction times for the system. The installation location for the ELM must be selected so that the electrical plug is pointing downward, to avoid malfunctions due to humidity. The two sites shown are permitted. The lever is simply turned in the other direction:

Preferred installation site

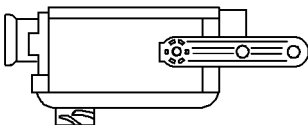

Alternative installation site

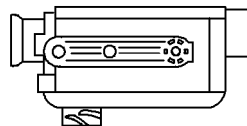

The maximum permitted tightening torque for the bolts, which are used to fasten the ELM to the vehicle frame is 7 Nm.

Mechanical linking

The linking angle of the lever of the ELM, based on the installation site, cannot be more than $\pm 60^\circ$ from the horizontal, the lever of the ELM may have to be lengthened so that the entire suspension path of the vehicle is covered.

Lever lengths between the measuring range of the ELM and the linking point of rod fastened to the axle are recommended between 150 to 300 mm. For this purpose, the lever **441 050 718 2** should be used, which is fastened by means of two bolts M6x16 and two self-locking nuts to the lever of the ELM.

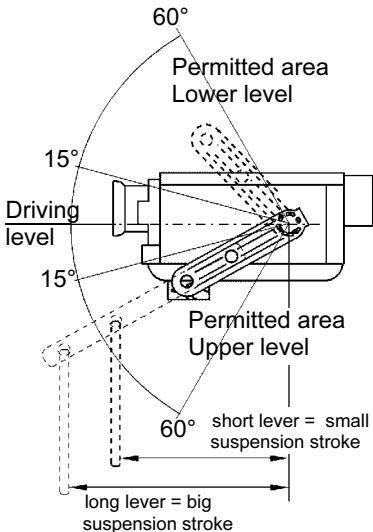

The optimum lever length is horizontal when the lever is in the normal level. The minimum angle of the ELM lever based on the normal lever must be

$\pm 15^\circ$. Smaller linking areas are associated with unsuccessful calibration. Optimum regulation is only possible when the lever angle is completely used.

Short levers are associated with the risk that the suspension path of the vehicle is not completely covered and the permitted measuring range is exceeded. This can result in measurement inaccuracies in the final positions and even destruction of the ELM.

Longer lever lengths reduce utilisation of the measured range. As the measuring resolution worsens, repetition accuracy drops and the risk of swinging increases.

Electrical supply

Finished, ready-for-use, sprayed cables are used for the electrical supply to the VCS or EBS. The ELM recognises the connected system by means of which pin the POWER/SIGNAL socket of the supply voltage is on.

For vehicles with VCS, a variant of the Y-cable **449 354 ... 0** is connected to the diagnosis socket of the VCS electronics. The diagnosis socket for VCS is on one of the outgoing lines, the ELM is on the other. The pins of the 7-pole Bayonet socket are occupied as follows:

1. Terminal 30
2. Terminal 31
3. Ignition (signal "terminal 15" transmitted via diagnosis line)
4. Not occupied
5. C3 signal

6. Infomaster
7. Not occupied

For vehicles with EBS, a deviation of the Y-cable **449 344 ... 0** is connected to the diagnosis/ISS output of the EBS modulator. The diagnosis socket for EBS is on one of the outgoing lines, the ELM is on the other. The pins of the 7-pole bayonet socket of the ELM are occupied as follows:

1. Not occupied
2. Terminal 31
3. Not occupied
4. 24V supply
5. ILS-signal
6. Infomaster
7. Not occupied

Connection remote control unit

For linking the socket to the remote control unit, a variant of the cable **449 633 ... 0** is used. It must be ensured that the plug connection to the cable of the remote control unit is in an area protected from splashing water (for example protective housing).

The remote control unit **446 056 116 0** should be used. Using another ECAS

control units is possible but this is the most suitable.

Putting into operation

Other systems connected to the ELM

First, EBS or VCS must be started, to make sure that there is voltage supply for the ELM.

There are no special instructions with respect to putting the VCS into operation.

When putting the EBS into operation, the ELM option must be activated when parameters are set. This is possible with TEBS Diagnosis Program 446 301 540 0 from version 3.0 or higher. (EBS-Modulator: device counter > 32.000)

Note:

ELM cannot be put into operation for EBS with diagnosis software versions of 2.0 and below.

Emergency Operation Mode, delivery state

Raising/Lowering possible, no regulation

ELM Calibration

After the ELM has been installed and the EBS or VCS have been put into operation, the ELM must be put into operation by calibrating the internal height sensor. For carrying out this, putting the ELM into operation mode, a control unit is essential.

In delivered state, the ELM is in an emergency operation mode, i.e. RAISE/LOWER with the help of the control unit is possible, but there is no level regulation. To get into the calibration mode, you must simultaneously press the RAISE and LOWER buttons while already pressing on the STOP button. You must press these three buttons for at least one second.

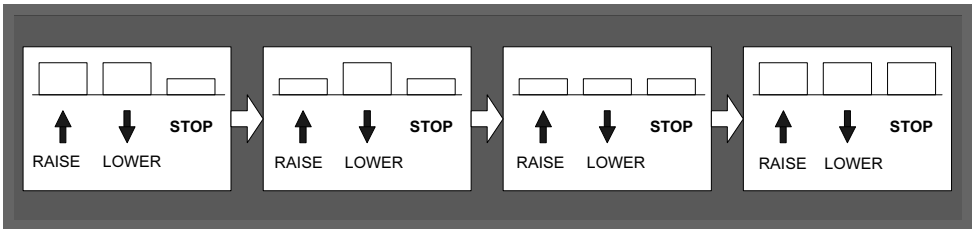

ELM acknowledges that you have successfully entered the calibration mode by means of 2 valve clicks.

The calibration of the upper, lower and driving level is not linked to any stipulat-

ed procedure. For example, two or more levels can be calibrated. As long as you are in the calibration mode, the calibration of individual levels can be repeated in any order. A level is calibrated as follows:

Calibration of a level

Press the axle pre-selection "rear axle" button. As control, the corresponding lamp should come on on the remote control unit.

Move to the level to be calibrated by pressing the button RAISE or LOWER.

Press the STOP button and while keeping it pressed ...

... Press on the driving level button for at least 1 second to **calibrate the driving level** => ELM confirms that the driving level has been successfully calibrated by one valve click.

... Press the RAISE button for at least 1 second in order to **calibrate the upper level** => the ELM confirms that the upper level has been successfully calibrated by one valve click.

... Press the LOWER button for at least 1 second in order to **calibrate the lower level** => the ELM confirms that the lower level has been successfully calibrated by one valve click.

After calibration move to a new level or leave the calibration mode.

To leave the calibration mode, you must press the STOP button on the remot control unit for at least 3 seconds. ELM acknowledges that you have successfully quit the calibration mode by means of three valve clicks.

When you leave the calibration mode, there is a calibration error examination during the three seconds: if there are calibration errors, there is no confirmation via the three valve clicks. In this case, the ELM is in emergency mode corresponding to the delivered state.

Calibration errors can arise due to:

- voltage is too low

- installation site for the ELM is not correct, i.e. the electrical connections do not point to the bottom
- calibrated levels are too close to each other - basic principle for the calibration:
there must be at least 15° between levels!

When ignition is OFF or when the vehicle starts to move ($V > 0\text{km/h}$) the calibration mode is automatically left.

After successful calibration via button "driving level" the chassis will be moved to the driving level.

You can calibrate again at any time.

Driving mode

Press the driving level button => you move to driving level

Memory Levels

Saving memory levels:

The ELM can save two memory levels. After pre-selecting the rear axle by pressing the corresponding axle pre-selection button on the remote control unit, which is confirmed by the fact that the axle pre-selection lamp comes on, you can put the assembly in the desired level by pressing the RAISE or LOWER button.

To save the set level as memory 1 or memory 2 level, you must press the corresponding M1 or M2 button while continuing to press on the STOP button on the remote control unit.

Calling up the memory levels:

In order to recall the saved level as memory 1 or memory 2 level, you must now press the corresponding M1 or M2 button on the remote control unit. The saved memory values are kept even after the ignition is OFF. They are only removed when you change the values for the M1 or M2 buttons.

Preconditions for functioning

- For raising the chassis, there must be enough pressure in the air reservoir.
- For regulating the height of the chassis, the ELM must be parameterised.
- The connected EBS cannot indicate any errors, and the ELM option must be parameterised.
- The ABS plug must be connected with the tractor unit and the ignition must be turned on.



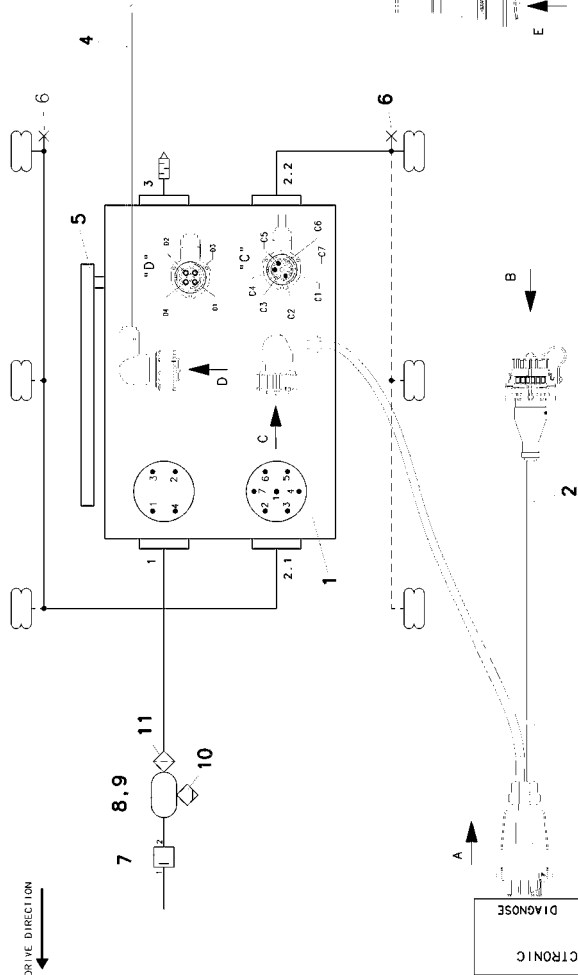
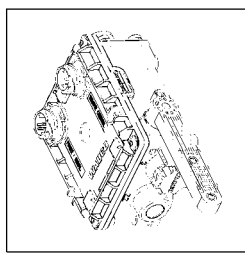

CHAMBER	CHAMBER
D1	E1
D2	E2
D3	E3
D4	E4

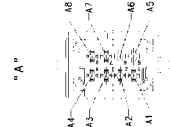

CHAMBER	CHAMBER
A1	B4
A2	B1
A3	B7
A4	C4
A5	
A6	
A7	C2
A8	C5

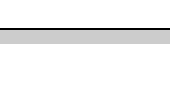

CHAMBER	CHAMBER
D1	E1
D2	E2
D3	E3
D4	E4

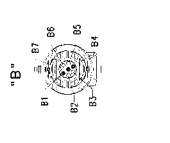
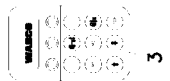

DATE	07-10-03	DATE	07-10-03
CONTRACT NO.		CONTRACT NO.	
DRIVE	DRIVE	DRIVE	DRIVE
WABCO	WABCO	WABCO	WABCO
CREATED	1-2-3	CREATED	1-2-3
TRAMM	1-2-3	TRAMM	1-2-3
SYMBOLENZUHL	1-2-3	SYMBOLENZUHL	1-2-3
FOR EBS		FOR EBS	
PRODUCT IDENTIFICATION NO.	841 801 790 0	PRODUCT IDENTIFICATION NO.	841 801 790 0
SIZE	CODE FOR	SIZE	CODE FOR
171	402 01	171	402 01
078429 A 01-11-06	078429 A 01-11-06	078429 A 01-11-06	078429 A 01-11-06
REVISION NO.	REVISION NO.	REVISION NO.	REVISION NO.
0407	0407	0407	0407

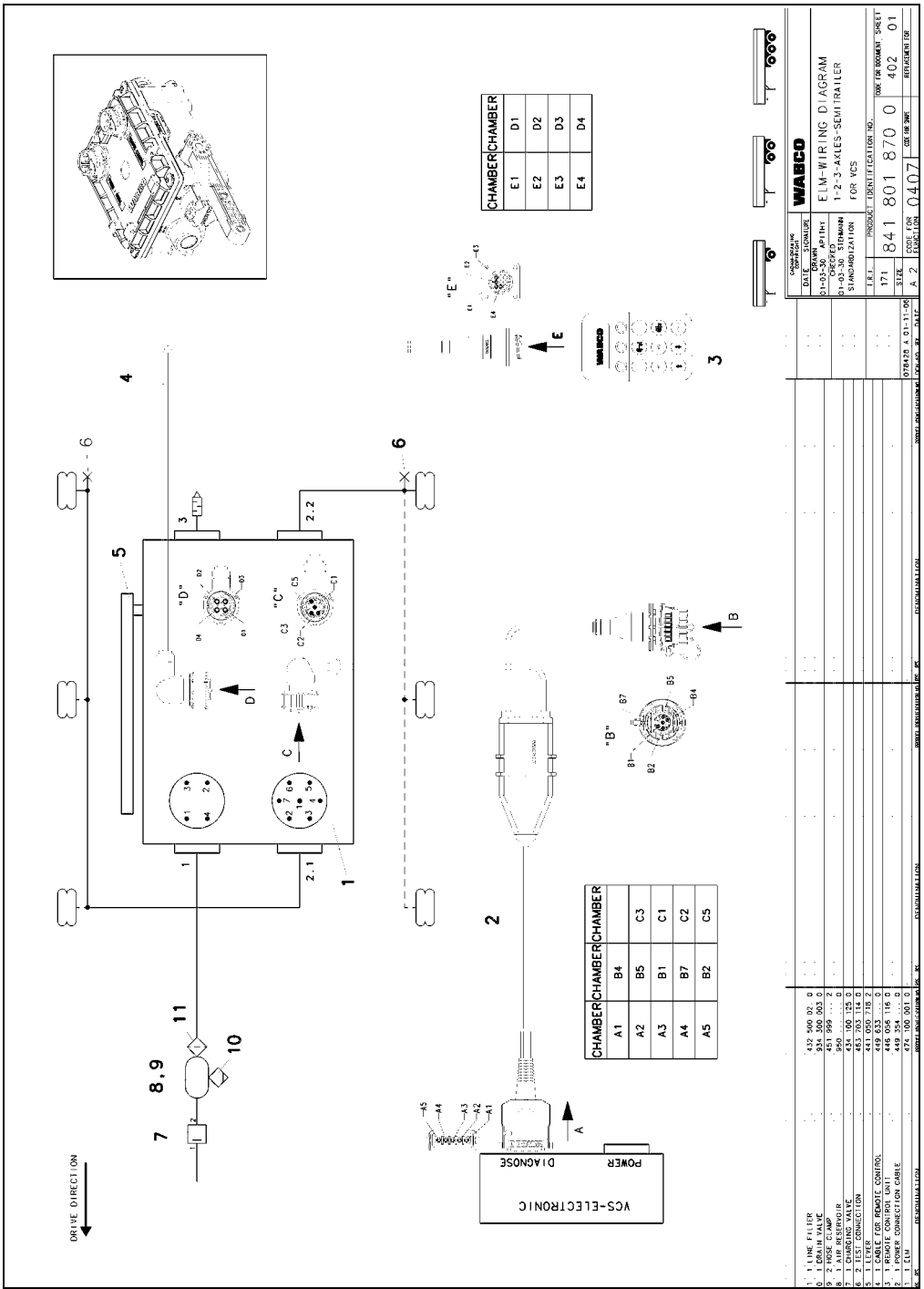





WABCO Vehicle Control Systems (NYSE: WBC) is a leading supplier of safety and control systems for commercial vehicles. For over 140 years, WABCO has pioneered breakthrough electronic, mechanical and mechatronic technologies for braking, stability, and transmis-

sion automation systems supplied to the world's leading commercial truck, trailer, and bus manufacturers. WABCO is headquartered in Brussels, Belgium.

For more information, visit www.wabco-auto.com

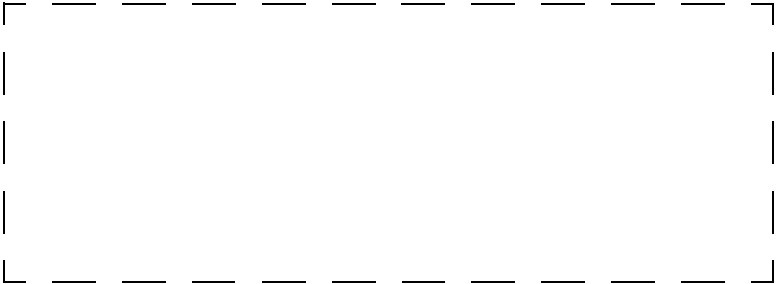

WABCO