

Test Report

No.: TUEH - TB 2007 - 019.02

on the basis of Test Instructions

98/91/EG, ECE-R 105

and chapter 9.2.2 Annex B, part 9 ADR 2011

TÜV Technische Überwachung Hessen GmbH

Automotive



Type : **Trailer EBS E**
Manufacturer : **Wabco GmbH**

Page: 1

Test report No.: TUEH - TB 2007 - 019.02

In accordance with the Directive of the European Council
Relating to the
Technical unit

Trailer EBS E 98/91/EG dated 14.12.1998 ECE-R 105 including amendment 05 and Chapter 9.2.2 ADR 2011

Approval status		
EEC	Approval number / Test Report	Date
	e1*72/245*2006/28*4868*00 e1*72/245*2006/28*4868*01 e1*72/245*2006/28*4868*02 e1*72/245*2006/28*4868*03 (EMC approval)	15.12.2006 11.01.2007 <u>04.03.2010</u> <u>28.07.2011</u>
EEC / ECE	Trailer ALD, category A 71/320*EEC annex X subclause 6.3.2 ECE-R 13 annex 13 subclause 6.3.2 Approval Report No.: EB 123.10E (attestation by Kraftfahrt-Bundesamt ¹)	<u>09.09.2011</u> <u>23.09.2011</u>
EWG / ECE	Braking system with electrical control transmission device 71/320*EEC annex XIV ECE-R 13 annex 19 Approval Report No.: EB 124.6E (attestation by Kraftfahrt-Bundesamt ¹)	<u>14.12.2010</u> <u>12.08.2011</u>

Name and address of the test laboratory : TÜV Technische Überwachung Hessen GmbH
-Automotive-
Werner-von-Siemens-Str. 35
D-64319 Pfungstadt
Telefon: 06157 9875 220
Telefax: 06157 9875 100
Email: helmut.preiss@tuevhessen.de

Name and address of applicant : WABCO GmbH
Am Lindener Hafen 21
DE-30453 Hannover
<http://www.wabco-auto.com>

¹ German Federal Motor Vehicle Approval Agency



Type : **Trailer EBS E**
Manufacturer : **Wabco GmbH**

Page: 2

0. General

- 0.1. Make
(trade name of the manufacturer) : **WABCO**
- 0.2. Type : **Trailer EBS E**
Commercial description : **Trailer EBS E**
Trailer EBS E with TCE
- 0.3. Marking of type, if present on the
separate technical unit (b); : [480 102 030 0 – 480 102 058 0](#)
[480 102 030 7 – 480 102 058 7](#)
[480 102 030 R – 480 102 058 R](#)
[480 102 060 0 – 480 102 079 0](#)
[480 102 060 7 – 480 102 079 7](#)
[480 102 060 R – 480 102 079 R](#)
[480 102 080 0 – 480 102 088 0](#)
[480 102 080 7 – 480 102 088 7](#)
[480 102 080 R – 480 102 088 R](#)
- 0.4. Location of that marking : **On the identification plate**
- 0.5. Name and address of the manufacturer : **WABCO GmbH**
Am Lindener Hafen 21
D-30453 Hannover
Germany
- 0.6. Description of the system : **System Specification 400 200 220 0 / doc. 535**
- 0.7. Location of EEC type approval mark,
method of applying the mark : **Raised on a recessed background, on the connector
frame side**
- 0.8. Modifications : **- Updating of the attracted approvals**
- Updating of means of identification of type
- Updating the applied directives



Type : **Trailer EBS E**
Manufacturer : **Wabco GmbH**

Page: 3

1. Vehicle part

1.1. Description

1.1.1.. **Modulator: variants** : [480 102 030 0 - 480 102 058 0](#) Standard
[480 102 030 7 – 480 102 058 7](#)
[480 102 030 R – 480 102 058 R](#)

[480 102 060 0 - 480 102 079 0](#) Premium
[480 102 060 7 – 480 102 079 7](#)
[480 102 060 R – 480 102 079 R](#)

[480 102 080 0 - 480 102 088 0](#) MultiVoltage
[480 102 080 7 – 480 102 088 7](#)
[480 102 080 R – 480 102 088 R](#)

1.1.2 **Connections, pneumatic:** : 1 Supply reservoir
2.X Brake actuator
3 Discharge
4 Control pressure
5 Air suspension bellows

1.1.3 **Connector locations, electrical:** : Modulator
Power
Subsystems
In/Out
ABS e/GIO 7
ABS c
ABS d
ABS f/GIO 6
GIO 1-5

1.1.4 **Connecting cable:** : Coat isolation of power cable (bulk stock) made out of PUR or optionally of PVC
Further description see appendix 1

1.1.6 **Installation instructions:** [480 102 089 0 / doc. 653](#)
[400 200 220 0 / doc. 535](#)
[449 000 000 0 / doc. 611](#)



Type : **Trailer EBS E**
Manufacturer : **Wabco GmbH**

Page: 4

2. Testing protocol

2.1. Test results

- 2.1.1. General : Taking into account the directives stated above, the **EBS Modulator** was tested for its suitability for trailers permitted for the transportation of dangerous goods. The scope of testing also includes the connecting cables stated above, installed in the relevant connections. IP54 is the minimum degree of protection demanded for electrical plug connections in ADR vehicles (GGVS (Act Governing the Road Haulage of Hazardous Materials (Germany))).
- 2.1.2. Tests on vehicle : The applicant presented the above-mentioned **EBS Modulator** in a braking-system model.

2.2. Scope

- 2.2.1. Trailer specification : All **O₃** and **O₄** trailers requiring a Registration Certificate for the transport of certain dangerous goods (see clause 2.2.3.).
- 2.2.2. Designation of vehicle body according to 9.1.1.2 directive ADR 2011 : Vehicle **EX/II** or **EX/III**
Vehicle **FL**
Vehicle **OX**
Vehicle **AT**
Vehicle **MEMU**
- 2.2.3. Definition of O₃ and O₄ trailers (for point 2.2.1.) : In accordance with Framework Directive 2007/46/EG, annex II, clause A, subclause 3 :
- Vehicle category O Trailers (including semi-trailers).
- 2.2.3.1. Vehicle category O₃ : Trailers with a maximum permitted mass exceeding 3,5 tonnes but not exceeding 10 tonnes.
- 2.2.3.2. Vehicle category O₄ : Trailers with a maximum permitted mass exceeding 10 tonnes.



Type : **Trailer EBS E**
Manufacturer : **Wabco GmbH**

Page: 5

2.2.4. In accordance with ADR 2011, part 9, chapter 9.1, subclause 9.1.1.2

2.2.4.1. vehicle EX/II or EX/III : A vehicle intended for the carriage of explosives or objects including explosive material (class 1)

2.2.4.2. vehicle FL : a) A vehicle intended for the carriage of liquids with a flashpoint of not more than 60 °C (with the exception of Diesel fuels according to the standard EN 590:2004, gas oil or heating oil (light) – UN number 1202 – with a flashpoint according to standard EN 590:2004) in fixed tanks or mountable tanks having a volumetric capacity of more than 1 m³ or in tank containers or portable tanks having a volumetric capacity of more than 3 m³ per single reservoir
or
b) A vehicle intended for the carriage of flammable gases in fixed tanks or mountable tanks having a volumetric capacity of more than 1 m³ or in tank containers or portable tanks or MEGC having a volumetric capacity of more than 3 m³ per single reservoir
or
c) A battery-vehicle with a total capacity of more than 1 m³ for the carriage of flammable gases.

2.2.4.3. vehicle OX : A vehicle intended for the carriage of hydrogen peroxide, stabilized, or of hydrogen peroxide, aqueous solution, stabilized with more than 60 % hydrogen peroxide (class 5.1 UN number 2015) in fixed tanks or mountable tanks having a volumetric capacity of more than 1 m³ or in portable tanks having a volumetric capacity of more than 3 m³ per single reservoir.

2.2.4.4. vehicle AT : a) A vehicle other than those of type EX/III, FL or OX intended for the carriage of dangerous goods in fixed tanks or mountable tanks having a volumetric capacity of more than 1 m³ or in tank containers, portable tanks or MEGC having a volumetric capacity of more than 3 m³ per single reservoir
or
b) A battery vehicle having a volumetric capacity of more than 1 m³ which is not a vehicle FL.

2.2.4.5. vehicle MEMU : A vehicle which complies with the definition "Mobile unit for the production of explosive substances or objects containing explosive materials " given in section 1.2.1.



Type : **Trailer EBS E**
Manufacturer : **Wabco GmbH**

Page: 6

2.2.5. Definition of the zones supplements to the vehicles FL according to 2.2.4.2. : In its subclause 9.7.8.2, the ADR gives an explanation of the classification of zones 0 and 1. Together with the application of the relevant explosion protection regulations and their instructions for implementation, these explanations are the basis for the general indications stated here.

2.2.5.1. Zone 0 : Zone 0 comprises areas in which an explosive atmosphere is present continuously or for long periods. In case of tank trucks, vehicles having tanks and battery vehicles, this is, for instance,
- the internal of the tanks, armatures and lines used for filling or delivering and for gas return

2.2.5.2. Zone 1 : Zone 1 comprises areas in which an explosive atmosphere is likely to occur in normal operation. In case of tank trucks, vehicles having tanks and battery vehicles, this is, for instance,
- the internal of closed armature boxes
- within a radius of 0.5 m around the armatures
- within a radius of 0.5 m around the venting equipment which cannot be shut off and is open under normal operating conditions (such as tipping valve)
- within a radius of 0.5 m around the safety valves

2.2.5.3. Zone 2 : Zone 2 comprises areas in which an explosive atmosphere is not likely to occur in normal operation and, if it does occur, is likely to do so only infrequently and will exist for a short period only.

2.3. Conditions

2.3.1. Ground return line : When fitting and installing an **EBS modulator** into a trailer having the ADR certificate, **the ground return line must not be routed via vehicle frame.** The maximum intensity of current must not exceed the device-specific permitted current of the line and connection.



Type : **Trailer EBS E**
Manufacturer : **Wabco GmbH**

Page: 7

- 2.3.2. Installation position of the EBS : The suitable location on the trailer has to be decided first. The installation has to be done in accordance with system documentation (Installation Instruction). The installation in FL vehicles has to be made outside the areas of zone 0 and 1 (according to chapter 2.2.5.)! Additional batteries in trailers have to be operable by means of a disconnection switch (Emergency OFF) in ADR-vehicles.
- 2.3.3. Fixation of cables : In order to prevent any vibration transfer to connectors or connector sealings, the free cable length between connector and cable clip shall not exceed 30 cm (except the cable ensuring the connection to the towing vehicle). Fastening of cables shall be such as to prevent any chafing.
- 2.3.4. Load room of EX/III vehicles : If the load room of EX/III vehicles is provided or permitted for goods of the compatible group J (= *objects that contain both explosive materials and flammable liquids, or flammable gel*), there are only electrical equipment parts in the load room allowed, corresponding at least the protection degree IP65.
- 2.4. Summary of assessment** : **From the technical point of view, there are no objections to the installation of the EBS modulator in trailers which according to ADR 2011 are subject to the special rules defined for the transport of dangerous goods, if the installation complies with the conditions stated above.**
- 2.5. General indications**
- Date of testing : 16 May, 2012



Type : **Trailer EBS E**
Manufacturer : **Wabco GmbH**

Page: 8

3. Appendices

1. : Connecting cables on positions of the EBS E modulator
2. : Illustration of the system connections
3. : Arrangement of the EBS E trailer modulator in combination with a semi-trailer
4. : Arrangement of the EBS E trailer modulator in combination with a draw-bar trailer
5. : Trailer EBS E system nameplate [example]

4. Statement of conformity

The system description given in section No. 0.6. and the vehicle part stated in this description -
- comply - with the directives stated above

This report includes pages 1 to 8 and the appendices.

Duplication and publishing in extracts of the Test Report is allowed only by written permission of the Test Laboratory.

TEST LABORATORY
- Automotive -
TÜV Technische Überwachung Hessen GmbH
ECE-R 105
designated by designation authority of **Kraftfahrt-Bundesamt,**
Federal Republic of Germany
under the registration number:
KBA-P 00005-95





64319 Pfungstadt, 21.05.2012
42469304





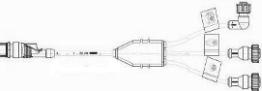

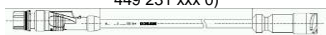

Dipl.-Ing. Preiss



Type : **Trailer EBS E**
Manufacturer : **Wabco GmbH**

Slot	Device plugs/ device sockets Interface plugs	Degree of pro- tection	Possible connecting cables (Product-Identification-No.:)	Termination device plug/ device socket Disconnecting plug	Degree of pro- tection	Cable end / Requirements <small>[Installation instructions for cables see 449 000 000 0/doc 653]</small>
Modulator	Connector housing 8-pole Cod. B Table drawing 894 101 801 2	IP 6K9K	449 436 XXX 0 Modulator cable EBS relay valve 480 207 001 0 	4 -pole DIN bayonet ISO 15170-B1-3.1-Sn/K1	IP 6K9K	3x 1.0mm ²
		IP 6K9K	449 429 XXX 0 Modulator cable ABS relay valve 472 195 037 0 	4 -pole DIN bayonet ISO 15170-BI-2.1-Sn/K1	IP 6K9K	2x 1.5mm ²
				4 -pole DIN bayonet ISO 15170-B1-3.1-Sn/K1		3x 0.5mm ²
4 -pole DIN bayonet ISO 15170-B1-3.1-Sn/K1	3x 1.0mm ²					
POWER	Connector housing 8-pole Cod. A Table drawing 894 101 801 2	IP 6K9K	449 173 XXX 0 Power cable for semi-trailer ¹⁾ 	ISO 7638 7-pole Socket	IP 54	7-core supply line to ISO 7638
		IP 6K9K	449 273 XXX 0 Power cable for drawbar trailer ¹⁾ 	7-pole ISO 7638 Socket	IP 54	7-core supply line to ISO 7638
		IP 6K9K	449 347 XXX 0 Power cable for intermediate connector ¹⁾ (further cable 449 133 xxx 0 a.a. 449 233 xxx 0) 	7-pole Bayonet connector	IP 6K9K	7-core supply line to ISO 7638 Tightness in combination with WABCO mating connector.
		IP 6K9K	449 353 XXX 0 Power cable for intermediate con- nector ¹⁾ (further cable 449 135 xxx 0 a.a. 449 231 xxx 0) 	7-pole Bayonet connector	IP 6K9K	7-core supply line to ISO 7638 Tightness in combination with WABCO mating connector.

Type : **Trailer EBS E**
Manufacturer : **Wabco GmbH**

Slot	Device plugs/ device sockets Interface plugs	Degree of pro- tection	Possible connecting cables (Product-Identification-No.:)	Termination device plug/ device socket Disconnecting plug	Degree of pro- tection	Cable end / Requirements [Installation instruc- tions for cables see 449 000 000 0/doc 653]
POWER	Connector housing 8-pole Cod. A Table drawing 894 101 801 2	IP 6K9K	449 371 XXX 0 Power cable with open end ¹⁾ 	7-core cable with open ends	--	7-core supply line to ISO 7638/ ISO 4141-3 Suitable ADR instal- lation required, min. IP54!
	Subsystem	Connector housing 8-pole Cod. C Table drawing 894 101 801 2	IP 6K9K	449 303 XXX 0 Supply voltage ELEX ¹⁾ 446 122 079 0 	Connector housing 8 pol. Cod. E Table drawing 894 100 005 2	IP 6K9K
		IP 6K9K	449 437 XXX 0 8-pole Universal with open ends 	8-core sheathed ca- ble with open ends	--	5x 1.0mm ² 3x 0.5mm ² Suitable ADR instal- lation required, min. IP54!
		IP 6K9K	449 627 XXX 0 EACS control box 446 156 01X 0 	7-pole Bayonet connector [4 assigned]	IP 6K9K	4x 0.5mm ²
		IP 6K9K	449 628 XXX 0 EACS control unit 446 056 xxx 0 	9 pole CPC connector [4 assigned]	IP 6K9K	4x 0.5mm ² Suitable ADR instal- lation required, min. IP54!
		IP 6K9K	449 911 XXX 0 Smartboard 446 192 11x 0 	7-pole Bayonet connector [5 assigned]	IP 6K9K	5x 0.5mm ²

Appendix 1 to Test Report

No.: TUEH - TB 2007 - 019.02

on the basis of Test Instructions

98/91/EG, ECE-R 105

and chapter 9.2.2 Annex B, part 9 ADR 2011





TÜV Technische Überwachung Hessen GmbH

Automotive

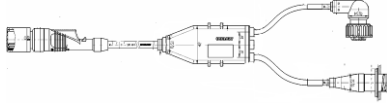

Type : **Trailer EBS E**
 Manufacturer : **Wabco GmbH**

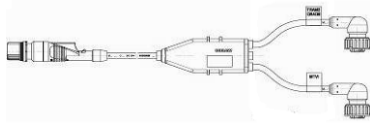



Page: 3

Slot	Device plugs/ device sockets Interface plugs	Degree of pro- tection	Possible connecting cables (Product-Identification-No.:)	Termination device plug/ device socket Disconnecting plug	Degree of pro- tection	Cable end / Requirements [Installation instruc- tions for cables see 449 000 000 0/doc 653]
sSubsystem	Connector housing 8-pole Cod. C Table drawing 894 101 801 2	IP 6K9K	449 912 XXX 0 Smartboard / Remotecontrol 446 192 11x 0 	7-pole Bayonet connector [5 assigned]	IP 6K9K	5x 0.5mm ²
		IP 6K9K	449 913 XXX 0 IVTM 446 220 01x 0 	7-pole Bayonet connector [4 assigned]	IP 6K9K	2x 1.0mm ² 2x 0.5mm ²
		IP 6K9K	449 914 XXX 0 Telematics 	4-pole DIN bayonet [4 assigned] ISO 15170-B1-4.1- Sn/K1	IP 6K9K	2x 1.0mm ² 2x 0.5mm ²
		IP 6K9K	449 916 XXX 0 Smartboard plus IVTM 446 192 11x 0 446 220 01x0 	7-pole Bayonet connector [5 assigned]	IP 6K9K	5x 0.5mm ²
IP 6K9K	449 917 xxx 0 Telematics 446 290 1xx 0 	6-pole Connector, [5 assigned]	IP 67	5x 0.5mm ²		

**Appendix 1
to Test Report**
No.: **TUEH - TB 2007 - 019.02**
on the basis of Test Instructions
98/91/EG, ECE-R 105
and chapter **9.2.2 Annex B, part 9 ADR 2011**



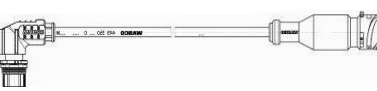

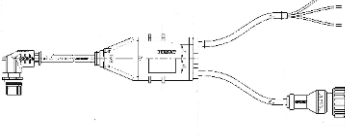

Type : **Trailer EBS E**
Manufacturer : **Wabco GmbH**

Slot	Device plugs/ device sockets Interface plugs	Degree of pro- tection	Possible connecting cables (Product-Identification-No.:.)	Termination device plug/ device socket Disconnecting plug	Degree of protection	Cable end / Require- ments [Installation instruc- tions for cables see 449 000 000 0/doc 653]
In/Out	Connector housing 4-pole Cod. C Table drawing 894 101 812 2	IP 6K9K	449 348 XXX 0 Supply voltage cable over TCE 446 122 001 0 	TCE Slot X22	IP 6K9K	2x 1.5mm ² 2x 0.5mm ²
		IP 6K9K	449 349 XXX 0 Supply voltage with open cable neds 24N 	2-core sheathed ca- ble with open ends	--	2x 1.5mm ² Suitable ADR in- stallation required, min. IP54!
		IP 6K9K	449 350 XXX 0 Supply voltage with coupling 24N 	4-pole DIN bayonet connector, ISO 15170-B1-2.1- Sn/K1	IP 6K9K	2x 1.5mm ² Degree of protection in combination with mating WABCO connector.
GIO1 GIO3-4	Connector housing 4-pole Cod. B Table drawing 894 101 812 2	IP 6K9K	449 813 XXX 0 Universal 2-core with open end 	2-core sheathed cable with open ends	---	2x 0.75mm ² Suitable ADR in- stallation required, min. IP54!
GIO1	Connector housing 4-pole Cod. B Table drawing 894 101 812 2	IP 6K9K	449 626 XXX 0 Traction help / unloading level / distance sensor 	3-core sheathed cable with open ends 3	---	3x 1.0mm ² Suitable ADR in- stallation required, min. IP54!
				4-pole DIN bayonet ISO 15170-B1-2.1- Sn/K1	IP 6K9K	2x 1.0mm ²

**Appendix 1
to Test Report**
No.: **TUEH - TB 2007 - 019.02**
on the basis of Test Instructions
98/91/EG, ECE-R 105
and chapter **9.2.2 Annex B, part 9 ADR 2011**

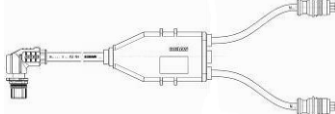

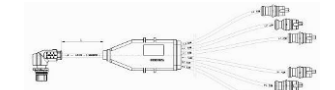



Type : **Trailer EBS E**
Manufacturer : **Wabco GmbH**

Slot	Device plugs/ device sockets Interface plugs	Degree of pro- tection	Possible connecting cables (Product-Identification-No.:.)	Termination device plug/ device socket Disconnecting plug	Degree of protection	Cable end / Require- ments [Installation instruc- tions for cables see 449 000 000 0/doc 653]
G101-4	Connector housing 4-pole Cod. B Table drawing 894 101 812 2	IP 6K9K	449 629 XXX 0 GIO Y-distributor 	3-pole	IP 68	3x 1.0mm ² Degree of protection in combination with mating WABCO connector.
				3-pole	IP 68	3x 1.0mm ² Degree of protection in combination with mating WABCO connector.
G101-7		IP 6K9K	449 443 XXX 0 Lift axle, RTR 463 084 xxx 0 	4-polig DIN bayonet [2 assigned] ISO 15170-B1-2.1- Sn/K1	IP 6K9K	2x 1.0mm ²
			449 535 XXX 0 Universal 4-pole with open ends 	4-core sheathed cable with open ends	---	4x 1.5mm ² Suitable ADR in- stallation required, min. IP54!
			449 816 XXX 0 Brake-lining wear sensors 	6 x 3-pole	IP 68	6x 2-core 2x 0.6mm ² Degree of protection in combination with mating WABCO connector
			449 819 XXX 0 BVA connecting cable connector 441 032 310 2 	2-pole	IP 68	2x 0.75mm ² Degree of protection in combination with mating WABCO connector



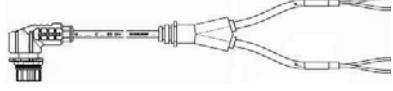

**Appendix 1
to Test Report**
No.: **TUEH - TB 2007 - 019.02**
on the basis of Test Instructions
98/91/EG, ECE-R 105
and chapter **9.2.2 Annex B, part 9 ADR 2011**

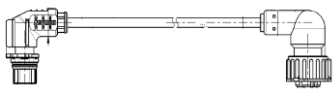
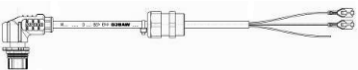

Type : **Trailer EBS E**
Manufacturer : **Wabco GmbH**

Slot	Device plugs/ device sockets Interface plugs	Degree of pro- tection	Possible connecting cables (Product-Identification-No.:	Termination device plug/ device socket Disconnecting plug	Degree of protection	Cable end / Require- ments [Installation instruc- tions for cables see 449 000 000 0/doc 653]
GIO1 GIO3-4	Connector housing 4-pole Cod. B Table drawing 894 101 812 2	IP 6K9K	449 812 XXX 0 Pressure sensor 441 040 015 0 441 044 002 0 	4-pole DIN bayonet [3-assigned] ISO 15170-B1-3.1- Sn/K1	IP 6K9K	3x 1.0mm ²
			449 815 XXX 0 3-pole Traction help + forced lowering (or unloading levl switch) 	2-core sheathed cable with open ends	---	2x 1.0mm ² Suitable ADR in- stallation required, min. IP54!
			449 811 XXX 0 Distance sensor 441 050 100 0 	2-core sheathed cable with open ends	--	2x 1.0mm ² Suitable ADR in- stallation required, min. IP54!
GIO1 GIO4	Connector housing 4-pole Cod. B Table drawing 894 101 812 2	IP 6K9K	449 811 XXX 0 Distance sensor 441 050 100 0 	4-polig DIN bayonet [2-assigned] ISO 15170-B1-2.1- Sn/K1	IP 6K9K	2x 1.0mm ²
GIO1-3	Connector housing 4-pole Cod. B Table drawing 894 101 812 2	IP 6K9K	449 445 XXX 0 ECAS valves 472 905 114 0 472 880 xxx 0 	4-pole DIN bayonet [3 assigned] ISO 15170-B1-3.1- Sn/K1	IP 6K9K	3x 1.0mm ²
GIO2	Connector housing 4-pole Cod. B Table drawing 894 101 812 2	IP 6K9K	449 439 XXX 0 (connection ECAS-block) 	4 pole DIN bayonet ISO 15170-B1-4.1- Sn/K1	IP 6K9K	4x 1.5mm ²



Type : **Trailer EBS E**
 Manufacturer : **Wabco GmbH**

Slot	Device plugs/ device sockets Interface plugs	Degree of pro- tection	Possible connecting cables (Product-Identification-No.:.)	Termination device plug/ device socket Disconnecting plug	Degree of protection	Cable end / Require- ments [Installation instruc- tions for cables see 449 000 000 0/doc 653]
G103	Connector housing 4-pole Cod. B Table drawing 894 101 812 2	IP 6K9K	449 519 XXX 0 ELM (connection electronic levelling module) 474 100 001 0 	7-pole byonet connector [3 assigned]	IP 6K9K	3x 1.0mm ²
G104	Connector housing 4-pole Cod. B Table drawing 894 101 812 2	IP 6K9K	449 438 XXX 0 EACS external with open ends 446 120 0xx 0 	3-core sheathed cable with open ends and 2x 6,3 contacts	--	3x 1.0mm ² Suitable ADR in- stallation required, min. IP54!
G105	Connector housing 4-pole Cod. B Table drawing 894 101 812 2	IP 6K9K	449 610 XXX 0 Telematics 	4-core sheathed cable with open ends	---	2x 1.0mm ² 2x 0.5mm ² Suitable ADR in- stallation required, min. IP54!
			449 611 XXX 0 CAN diagnostic cable Interface 446 300 348 2 	7-pole	IP 6K9K	2x 0.5mm ² 2x 1.0mm ²
			449 915 XXX 0 Telematics 	4 pole DIN byonet ISO 15170-B1-4.1- Sn/K1	IP 6K9K	2x 1.0mm ² 2x 0.5mm ²
			449 918 XXX 0 Telematics 446 290 1xx 0 	6-pole connector [5 assigned]	IP 67	2x 1.0mm ² 2x 0.5mm ²



Appendix 1
to Test Report
 No.: **TUEH - TB 2007 - 019.02**
 on the basis of Test Instructions
98/91/EG, ECE-R 105
 and chapter **9.2.2 Annex B, part 9 ADR 2011**

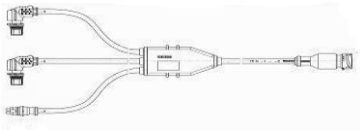
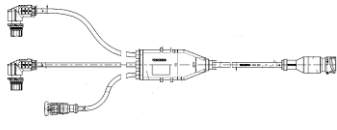

Type : **Trailer EBS E**
 Manufacturer : **Wabco GmbH**

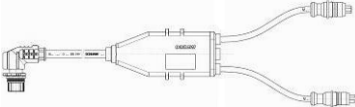

Slot	Device plugs/ device sockets Interface plugs	Degree of pro- tection	Possible connecting cables (Product-Identification-No.:	Termination device plug/ device socket Disconnecting plug	Degree of protection	Cable end / Require- ments [Installation instruc- tions for cables see 449 000 000 0/doc 653]
IN/OUT	Connector housing 4-pole Cod. C Table drawing 894 101 812 2	IP 6K9K	449 356 XXX 0 24N, traction help and forced lowering/-cable 	4 pole DIN bayonet ISO 15170-B1-3.1- Sn/K1	IP 6K9K	3x 1.5mm ² Degree of protection in combination with mating WABCO connector
	Connector housing 4-pole Cod. B Table drawing 894 101 812 2	IP 6K9K				
	external connection	2 pol. 2x 0,75mm ² Degree of protection in combination with mating WABCO connector				
IN/OUT	Connector housing 4-pole Cod. C Table drawing 894 101 812 2	IP 6K9K	449 357 XXX 0 24N, traction help cable 	4 pole DIN bayonet ISO 15170-B1-4.1- Sn/K1	IP 6K9K	4x 1.5mm ² Degree of protection in combination with mating WABCO connector
	Connector housing 4-pole Cod. B Table drawing 894 101 812 2	IP 6K9K				
	external connection	2 pol. 2x 0,75mm ² Degree of protection in combination with mating WABCO connector				
ABS e; c; d, f	Connector housing 4-pole Cod. A Table drawing 894 101 812 2	IP 6K9K	449 723 XXX 0 ABS sensor connection with connector 441 032 310 2 	2-pole	IP 68	2x 0.75mm ² Degree of protection in combination with mating WABCO connector

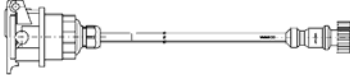
Type : **Trailer EBS E**
Manufacturer : **Wabco GmbH**

Slot	Device plugs/ device sockets Interface plugs	Degree of pro- tection	Possible connecting cables (Product-Identification-No.:)	Termination device plug/ device socket Disconnecting plug	Degree of protection	Cable end / Require- ments [Installation instruc- tions for cables see 449 000 000 0/doc 653]
GIO7, ABS e GIO6, ABS f	Connector housing 4-pole Cod. B Table drawing 894 101 812 2	IP 6K9K	449 818 XXX 0 ABS sensor/GIO 	1x 3-pole	IP 68	3x 1.0mm ² Degree of protection in combination with mating WABCO connector
				1x 2-pole	IP 68	2x 0.75mm ² Degree of protection in combination with mating WABCO connector
463 090 XXX 0 TASC valve	4 pole DIN bayonet ISO 15170-B1-2.1- Sn/K1	IP 6K9K	449 447 XXX 0 Y-cable in conjunction with connection cable 449 443 XXX 0; connection 2x TASC valve 463 090 XXX 0 	4 pole DIN bayonet ISO 15170-B1-2.1- Sn/K1	IP 6K9K	2x 1.5mm ² Degree of protection in combination with mating WABCO connector
				4 pole DIN bayonet ISO 15170-B1-2.1- Sn/K1	IP 6K9K	2x 1.5mm ² Degree of protection in combination with mating WABCO connector
Power connection cable	ISO 7638 Socket	IP 54	449 133 XXX 0 Power cable for semi-trailer with bayonett ¹⁾ (further cable 449 333 XXX 0) 	Bayonet 7-pole	IP 6K9K	2x 4.0mm ² 3x 1.5mm ² 2x 1.0mm ² Degree of protection in combination with mating WABCO connector
	ISO 7638 Socket	IP 54	449 135 XXX 0 Power cable for semi-trailer with bayonett ¹⁾ (further cable 449 335 XXX 0) 	Bayonet 7 -pole	IP 6K9K	2x 4.0mm ² 3x 1.5mm ² 2x 1.0mm ² Degree of protection in combination with mating WABCO connector



Type : **Trailer EBS E**
Manufacturer : **Wabco GmbH**

Slot	Device plugs/ device sockets Interface plugs	Degree of pro- tection	Possible connecting cables (Product-Identification-No.:)	Termination device plug/ device socket Disconnecting plug	Degree of protection	Cable end / Require- ments [Installation instruc- tions for cables see 449 000 000 0/doc 653]
Power connection cable	ISO 7638 Connector	IP 54	449 231 XXX 0 Power cable for drawbar trailers with bayonett ¹⁾ (further cable 449 335 XXX 0) 	Bayonet 7 -pole	IP 6K9K	2x 4.0mm ² 3x 1.5mm ² 2x 1.0mm ² Degree of protection in combination with mating WABCO connector
	ISO 7638 Connector	IP 54	449 233 XXX 0 Power cable for drawbar trailers with bayonett ¹⁾ (further cable 449 333 XXX 0) 	Bayonet 7 -pole	IP 6K9K	2x 4.0mm ² 3x 1.5mm ² 2x 1.0mm ² Degree of protection in combination with mating WABCO connector

Remarks/Notes:

1) Material of the cable coat insulaton optionally PUR or PVC

**Appendix 2
to Test Report**

No.: **TUEH - TB 2007 - 019.02**

on the basis of Test Instructions

98/91/EG, ECE-R 105

and chapter **9.2.2 Annex B, part 9 ADR 2011**

Type : **Trailer EBS E**
Manufacturer : **Wabco GmbH**

Illustration of the system connections (slots)

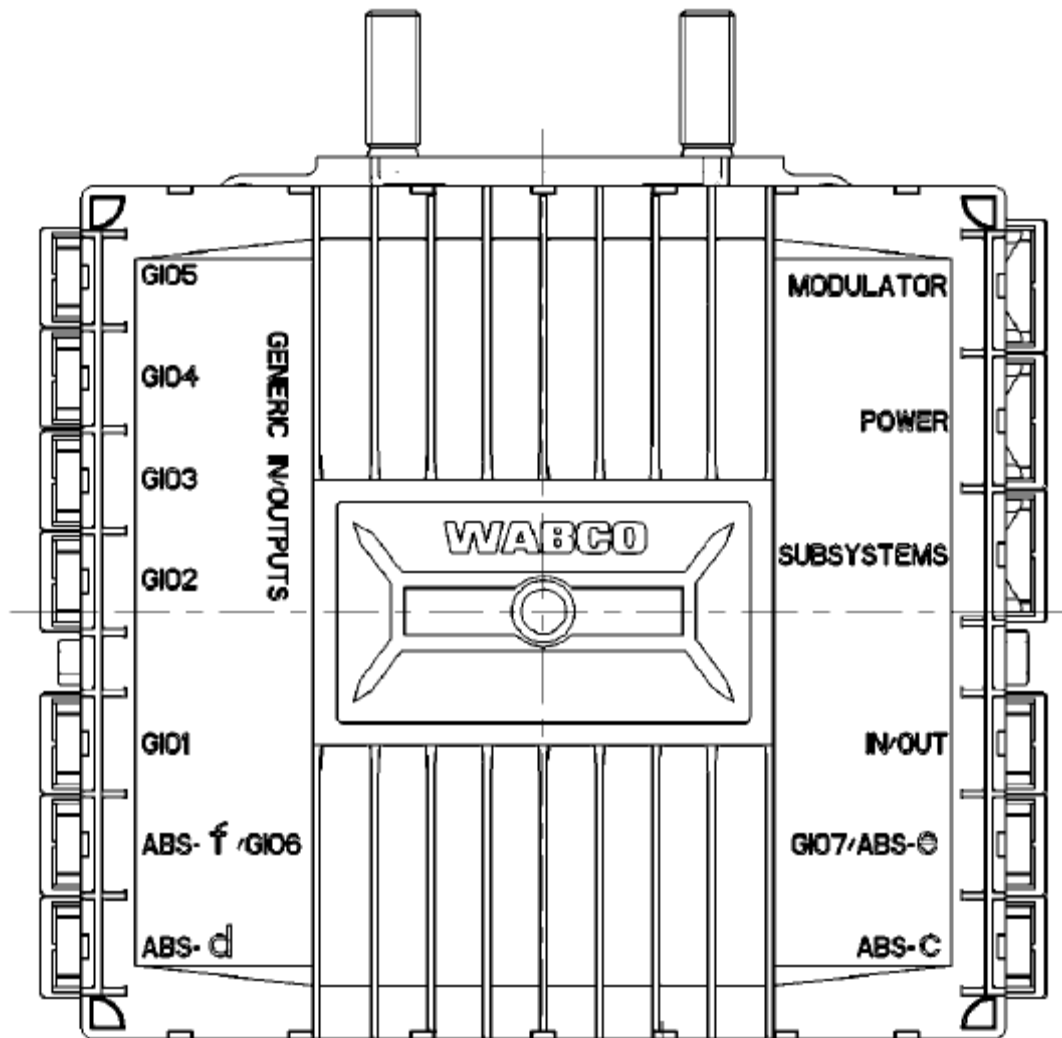

Type : **Trailer EBS E**
Manufacturer : **Wabco GmbH**

Page: 1

Arrangement of the EBS E trailer modulator in combination with a drawbar trailer

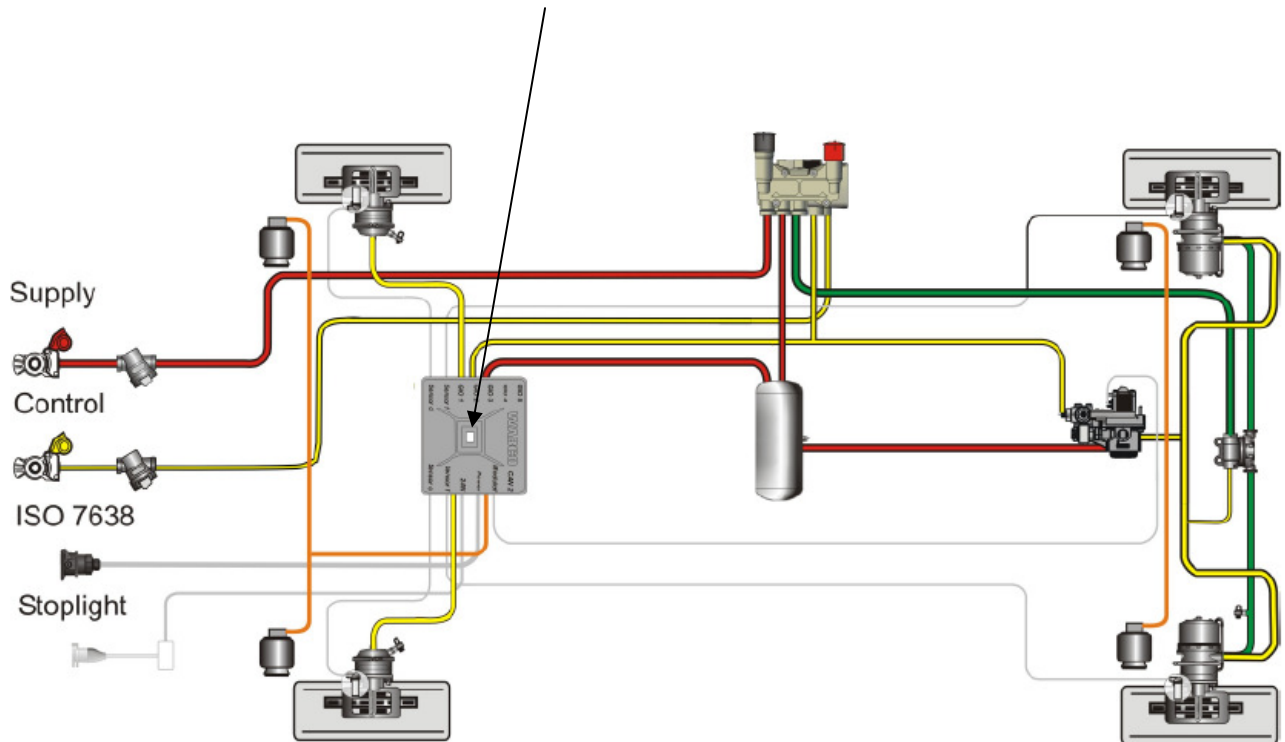

Appendix 5 to Test Report

No.: TUEH - TB 2007 - 019.02

on the basis of Test Instructions

98/91/EG, ECE-R 105

and chapter 9.2.2 Annex B, part 9 ADR 2011



Type : **Trailer EBS E**
 Manufacturer : **Wabco GmbH**

Trailer EBS E System nameplate [example]

WABCO		TRAILER EBS-E				E1 GGVS/ADR TUEH TB 2007 - 019.00 13R-XXXX XX			
HERSTELLER MANUFACTURER CONSTRUCTEUR		Musterbau				GIO	Pin1	Pin3	Pin4
TYP TYPE TYPE		Sattel				1	ISS1	---	---
FAHRZEUG IDENTNR. CHASSIS NUMBER NUMERO DE CHASSIS		WWWXXX1234				2	ILS1	---	---
BREMSBERECHNUNGS-NR. BRAKE CALCULATION NO. CALCUL DE FREINAGE NO.		WDE-xxx				3	FL	TH	---
POLRAZÄHNZÄHL c-d e-f POLE WHEEL TEETH c-d e-f DENTS ROUE DENTEE c-d e-f		100	---	ABS-System ABS-System Système ABS	2S/2M	4	LWI	---	---
RSS	Einfachbereifung Single Tyre Monte simple	X	Lenkachse Steering axle Essieu avant		5	---	---	---	
RSS	Zwillingsbereifung Twin Tyre Monte jumelle		Kippkritisches Fahrzeug Critical Trailer Vehicule critique		6	---	---	---	
Subsystems		IVTM / SB				7	---	---	---
		pm (bar)		6,5		pm (bar)		0,8 2 --- 6,5	
ACHSE AXLE ESSIEU		(kg)	(kg)	(kg)	(kg)	(kg)	(kg)	(kg)	(kg)
1	1200	0,5	1,3	9000	5	0,5	1,7	---	6,5
2	1200	0,5	1,3	9000	5	0,5	1,7	---	6,5
3	1200	0,5	1,3	9000	5	0,5	1,7	---	6,5
4	0	---	---	0	---	---	---	---	---
5	0	---	---	0	---	---	---	---	---