

# Válvula freno de mano

## Hand Brake Valve

961 723

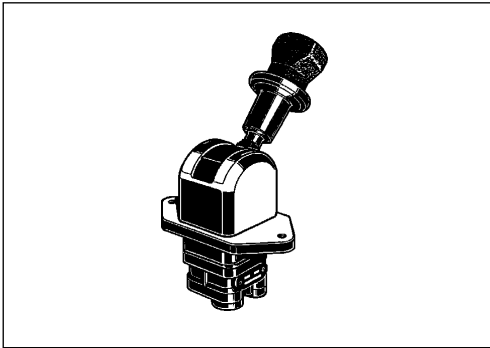

### Datos técnicos / Technical Data:

Presión de funcionamiento Operating pressure	max. 10 bar
Medio Permissible medium	aire / air
Rango de temperatura Operating temperature range	-40°C a/to +80°C

### Instalación / Installation:

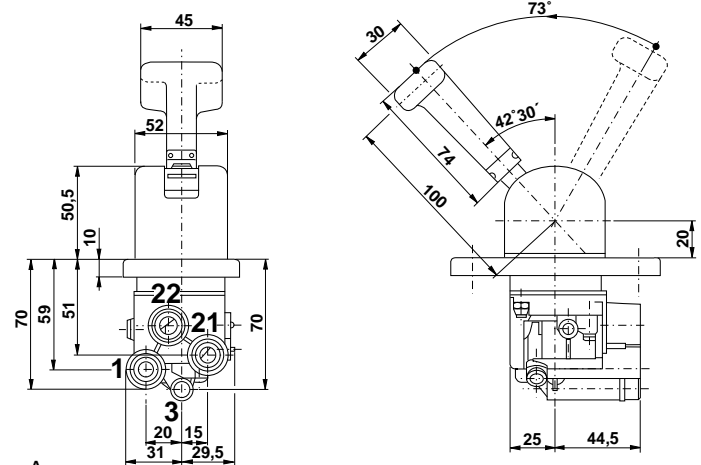
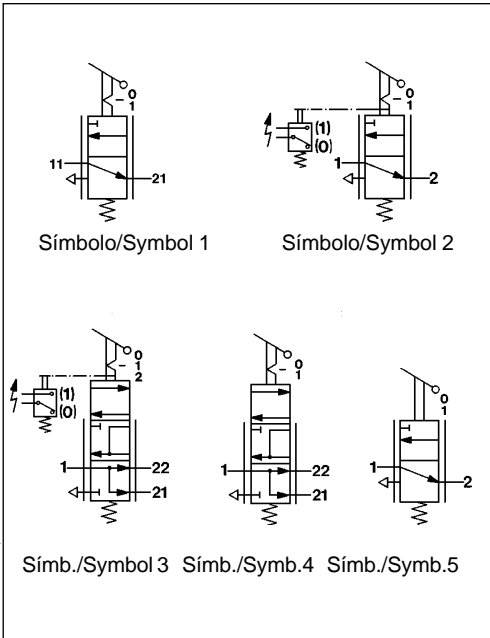

Tipo/Type A

Tipo/Type B

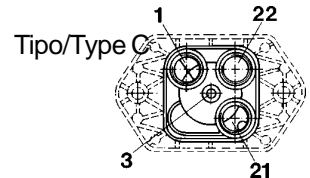
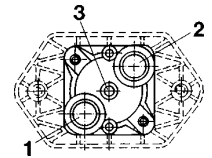

### Propósito:

Accionamiento sensible y graduado del freno auxiliar y accionamiento del freno de estacionamiento, en conjunción con el actuador de freno de muelle.

### Requisitos para la instalación:

La válvula freno de mano debe montarse en un panel con dos tornillos M6 ó M8.

### Purpose:

Sensitive graduated operation of the auxiliary brake and operation of the parking brake in conjunction with spring brake actuator.

### Installation Requirement:

The hand brake valve should be mounted on a panel with two M6 or M8 screws.

### Bocas / Ports:

- (1) 1 = Alimentación / Energy supply
- (2) 2 = Actuador de freno de muelle / Spring brake actuator
- 22 = Válvula de control remolque / Trailer control valve
- 3 = Escape / Exhaust

### Boquilla de escape / Venting nipple :

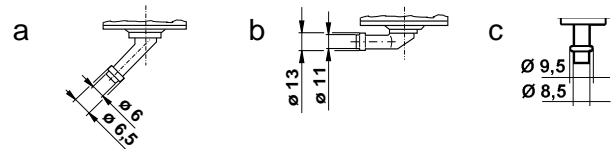

### Placas de soporte / Carrier plates:

Tipo de placa de sujeción Type of Carrier plate	Maß B	Maß A
I	M 6	80
II	M 8	90
III	Ø 6	80

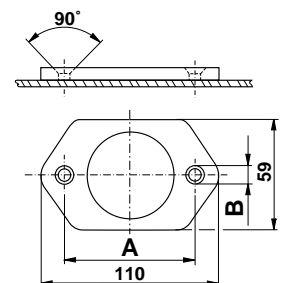

# Válvula freno de mano

## Hand Brake Valve

961 723

Explicaciones / Explanations:

Márgenes de funcionamiento / Operating range:

R= Posición de bloqueo / Locked position

Referencia Part Number	Característica Characteristic	Tipo/Type Símb./Symbol	Escape canalizado Venting nipple	Placa de sujeción Carrier plate	Mango Handle	Observaciones Comments
961 723 001 0		B 1	a	I		
		Bocas / Ports: M16x1,5				
961 723 005 0		A 1	b	II		
		Bocas / Ports: M16x1,5 Voss				
961 723 009 0		A 2	b	II		con conector eléctrico with electrical switch
		Bocas / Ports: M16x1,5 Voss				
961 723 017 0		A 1	a	I		
		Bocas / Ports: M16x1,5 Voss				
961 723 019 0		A 1	b	II		
		Bocas / Ports: M16x1,5 Voss				
961 723 023 0		A 2	b	I		con conector eléctrico with electrical switch
		Bocas / Ports: M16x1,5				
961 723 100 0		C 4	c	III		
		Bocas / Ports: M16x1,5 Voss				

# Válvula freno de mano

## Hand Brake Valve

961 723

Explicaciones / Explanations:

Márgenes de funcionamiento / Operating range:

R= Posición de bloqueo / Locked position

Referencia Part Number	Característica Characteristic	Tipo/Type Simb./Sym.	Escape canalizado Venting nipple	Placa de sujeción Carrier plate	Mango Handle	Observaciones Comments
961 723 104 0		A 4	b	II		
		Boca / Ports: M16x1,5 Voss				
961 723 106 0		A 3	b	I		con conector eléctrico with electrical switch
		Boca / Ports: M16x1,5				
961 723 107 0		A 3	b	II		con conector eléctrico with electrical switch
		Boca / Ports: M16x1,5 Voss				
961 723 108 0		C 4	a	I		
		Boca / Ports: M16x1,5				
961 723 110 0		A 4	a	I		
		Boca / Ports: M16x1,5 Voss				
961 723 112 0		A 4	b	II		
		Boca / Ports: M16x1,5 Voss				
961 723 117 0		A 3	b	I		con conector eléctrico with electrical switch
		Boca / Ports: M16x1,5				

# Válvula freno de mano











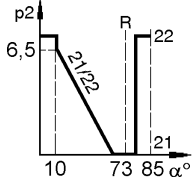

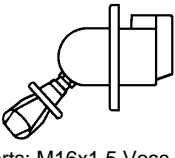
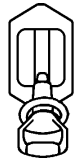
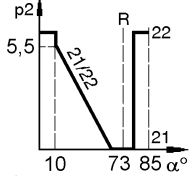

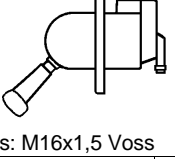
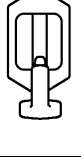
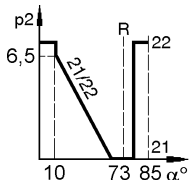
## Hand Brake Valve

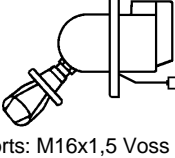
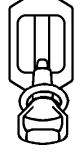
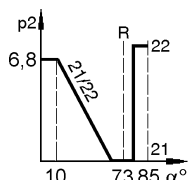
961 723

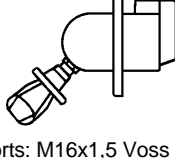
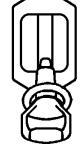
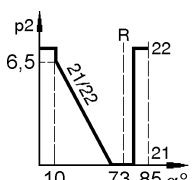
Explicaciones / Explanations:

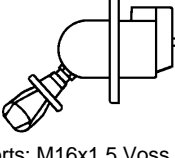
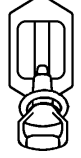
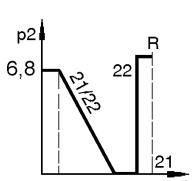
Márgenes de funcionamiento / Operating range:

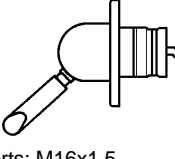
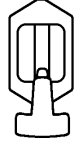
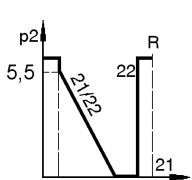
R= Posición de bloqueo / Locked position

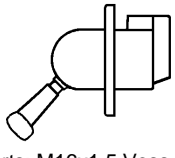
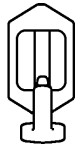
Referencia Part Number	Característica Characteristic	Tipo/Type	Símb./Sym.	Escape canalizado Venting nipple	Placa de sujeción Carrier plate	Mango Handle	Observaciones Comments
961 723 118 0		A	4	b	II		
							
				Bocas / Ports: M16x1,5 Voss			
961 723 119 0		A	4	b	II		
							
				Bocas / Ports: M16x1,5 Voss			
961 723 120 0		A	3	b	II		con conector eléctrico with electrical switch
							
				Bocas / Ports: M16x1,5 Voss			
961 723 126 0		A	4	a	I		
							
				Bocas / Ports: M16x1,5 Voss			
961 723 127 0		A	4	a	I		
							
				Bocas / Ports: M16x1,5 Voss			
961 723 200 0		C	4	a	I		
							
				Bocas / Ports: M16x1,5			
961 723 201 0		A	4	b	II		
							
				Bocas / Ports: M16x1,5 Voss			

# Válvula freno de mano

## Hand Brake Valve

961 723

Explicaciones / Explanations:

Márgenes de funcionamiento / Operating range:

R= Posición de bloqueo / Locked position

Referencia Part Number	Característica Characteristic	Tipo/Type	Símb./Sym.	Escape canalizado Venting nipple	Placa de sujeción Carrier plate	Mango Handle	Observaciones Comments
961 723 209 0		A	4	a	I		
				Bocas / Ports: M16x1,5 Voss			
961 723 401 0		B	5	a	I		
				Bocas / Ports: M16x1,5			
961 723 405 0		B	5	a	I		
				Bocas / Ports: M16x1,5			