

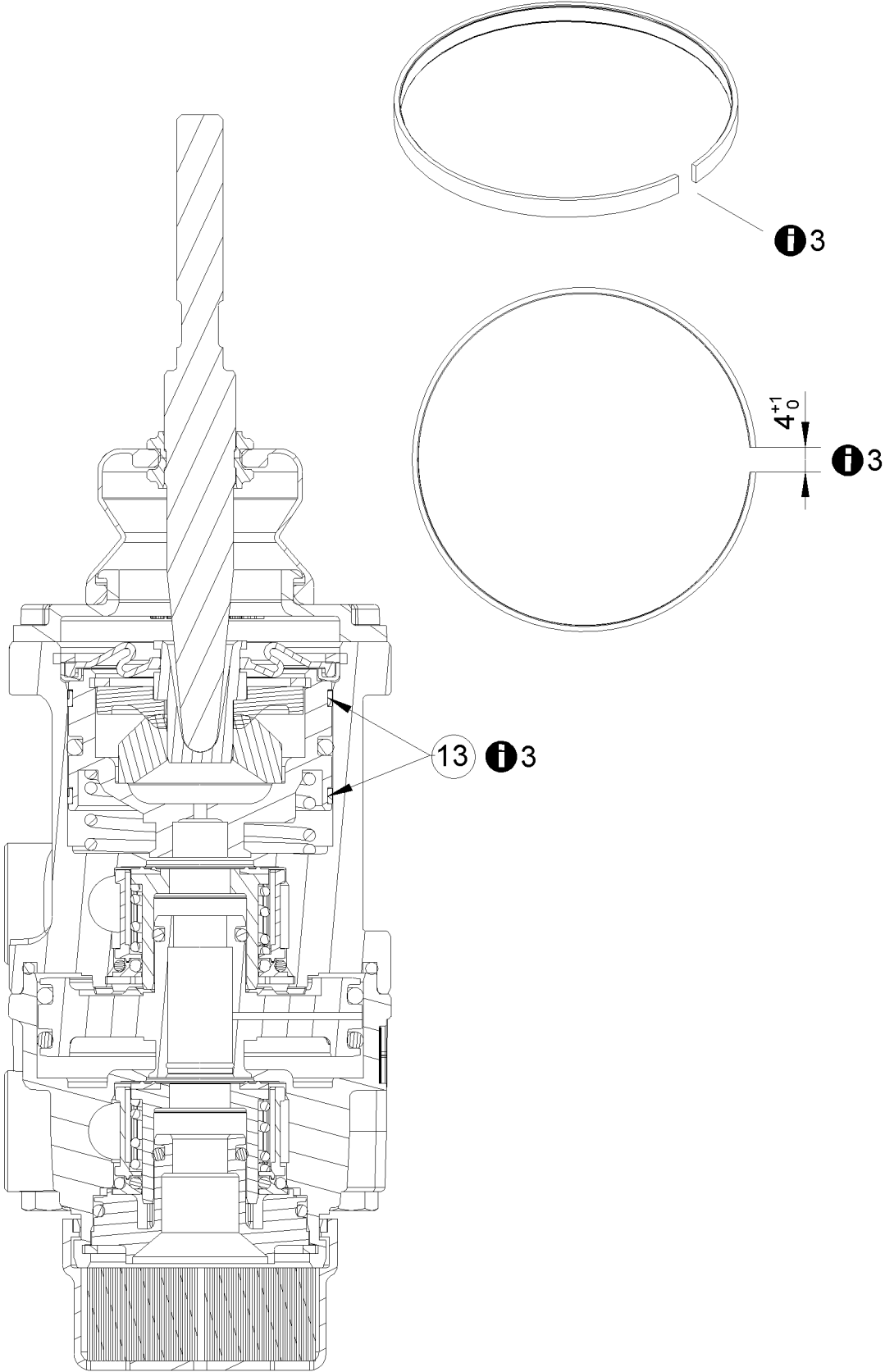





2



### Signální slova a symboly

-  **DANGER** NEBEZPEČÍ Bezprostředně hrozící nebezpečí: těžká újma na zdraví nebo smrt
-  **WARNING** POZOR Možná nebezpečná situace: jako následek lehká nebo středně těžká újma na zdraví nebo poškození majetku
-  **CAUTION** VÝSTRAHA Možná nebezpečná situace: jako následek těžká újma na zdraví nebo smrt
-  Díly, které mají číslo pozice v kroužku, jsou obsažené v opravárenské sadě.

 Instrukce / informace ke správnému provedení opravy

 Opravárenskou sadu je možné použít pro přístroje uvedené v tabulce.













 Součástku utáhněte uvedeným momentem.

**NOTE** Instrukce / informace ke správnému provedení opravy





### Všeobecné pokyny k opravám

1. Opravárenské práce na přístrojích systému, který má vliv na bezpečnost vozidla, smí provádět pouze kvalifikovaný personál odborné servisní dílny.
3. Dodržujte předpisy BOZP podniku a národní předpisy.
5. S opravou začněte teprve tehdy, až všechny informace nutné pro opravu přečtete a porozumíte jim. Další potřebné dokumenty: zkušební postup, list náhradních dílů, všeobecné pokyny pro opravu a kontrolu (815 150 109 3) naleznete na internetových stránkách: [www.wabco-auto.com](http://www.wabco-auto.com), když v databázi INFORM zadáte produktové číslo přístroje nebo číslo dokumentu.
7. WABCO nepřebírá žádnou záruku za funkci nebo kvalitu opraveného přístroje.
2. Postupujte bezpodmínečně podle pokynů a instrukcí výrobce vozidla.
4. Používejte výhradně náhradní díly od firmy WABCO nebo díly schválené výrobcem vozidla.
6. Na adekvátním zařízení přezkoušejte – podle zkušebního postupu – každý opravený přístroj na funkčnost a těsnost.

### Postup montáže

Obrázek	Symbol	Pozice	Utahovací moment:	Poznámky
	 1	1	3±0.5 Nm	Před dalším pracovním krokem se ujistěte, že jsou všechny šrouby utaženy správným momentem.
	 2	18	31±3 Nm	Před dalším pracovním krokem se ujistěte, že jsou všechny šrouby utaženy správným momentem.
	 3	37	8±1 Nm	Před dalším pracovním krokem se ujistěte, že jsou všechny šrouby utaženy správným momentem.
	 1			Namažte těsnící a kluzné plochy.100919910
	 2	11,14		Nasadte bez mazání!
	 3	13		Před montáží kroužek prořízněte (bez otřepů). Ujistěte se, že rozměr proříznuté štěrby je před i po zabudování stejný.

### Signalwörter & Symbole

-  **DANGER** GEFAHR Unmittelbar drohende Gefährdung: Schwere Personenschäden oder Tod
-  **WARNING** VORSICHT Mögliche Gefahrensituation: Leichte oder mittelschwere Personenschäden oder Sachschäden als Folge
-  **CAUTION** WARNUNG Mögliche Gefahrensituation: Tod oder schwere Personenschäden als Folge
-  Teile mit Kreis um die Positionsnummer sind im Reparatursatz enthalten.

 Anweisung / Information für eine korrekte Reparatur

 Der Reparatursatz kann für Geräte entsprechend Tabelle verwendet werden.

 Element mit angegebenen Drehmoment anziehen.







**NOTE** Anweisung / Information für eine korrekte Reparatur

de

## Allgemeine Reparaturhinweise





1. Reparaturarbeiten an Geräten eines Fahrzeug-Sicherheitssystems darf nur qualifiziertes Personal einer Fachwerkstatt durchführen.
2. Leisten Sie den Vorgaben und Anweisungen des Fahrzeugherstellers unbedingt Folge.
3. Halten Sie Unfallverhütungsvorschriften des Betriebes sowie nationale Vorschriften ein.
4. Verwenden Sie ausschließlich von WABCO oder vom Fahrzeughersteller freigegebene Ersatzteile.
5. Beginnen Sie die Reparatur erst dann, wenn Sie alle Informationen, die für die Reparatur notwendig sind, gelesen und verstanden haben. Zusätzlich benötigte Dokumente: Prüfanweisung, Ersatzteilblatt, Allgemeine Reparatur- und Prüfhinweise (815 020 109 3) zu finden auf [www.wabco-auto.com](http://www.wabco-auto.com) mittels Eingabe der Produktnummer des Gerätes bzw. Druckschriftennummer in INFORM.
6. Prüfen Sie jedes reparierte Gerät – gemäß Prüfanweisung – an einer adäquaten Einrichtung auf Funktionstüchtigkeit und Dichtigkeit.
7. WABCO übernimmt keinerlei Gewährleistung für die Funktion oder Qualität eines reparierten Gerätes



## Montage Reihenfolge

Bild	Symbol	Position	Anzugsdrehmoment:	Bemerkungen
<b>1</b>	 1	1	3±0.5 Nm	Stellen Sie vor dem nächsten Arbeitsschritt sicher, dass alle Schrauben das richtige Anzugsmoment haben.
<b>1</b>	 2	18	31±3 Nm	Stellen Sie vor dem nächsten Arbeitsschritt sicher, dass alle Schrauben das richtige Anzugsmoment haben.
<b>1</b>	 3	37	8±1 Nm	Stellen Sie vor dem nächsten Arbeitsschritt sicher, dass alle Schrauben das richtige Anzugsmoment haben.
<b>1</b>	 1			Fetten Sie die Dicht- und Gleitflächen ein.100919910
<b>1</b>	 2	11,14		Ohne Fett einsetzen!
<b>2</b>	 3	13		Schlitzten Sie den Ring vor der Montage (ohne Grat). Stellen Sie sicher, dass das Maß des Schlitzes vor und nach dem Einbau identisch ist.

en

## Symbols & Signal Words

-  **DANGER** Imminent hazard situation: serious personal injury or death as a result
-  **WARNING** Possible hazard situation: minor or moderate personal injury or material loss as a result
-  **CAUTION** Possible hazard situation: serious personal injury or death as a result
-  Parts having item numbers with circles are included in the kit.







-  Instruction / Information for a correct repair
-  The kit can be used for devices according table.
-  Fasteners must be tightened to a specific torque.
- NOTE** Instruction / Information for a correct repair

## General Repair Hints

1. Only qualified personnel of a specialist workshop are authorized to perform repair work on a vehicle's security system.
2. Absolutely follow specifications and instructions of vehicle manufacturer.
3. Keep to company's relevant accident prevention regulations and national regulations.
4. Use only spare parts released by WABCO or vehicle manufacturer.
5. Always start repair work only when you have read and understood all information required for repair. Documents additionally needed: Test Instruction, Spare Parts List, General Repair and Test Hints (815 010 109 3) to be found on [www.wabco-auto.com](http://www.wabco-auto.com) by entering product number of the device or the publication number in INFORM.
6. Check each repaired equipment for functional efficiency and tightness on an adequate facility according to the test instruction.
7. WABCO does not accept any liability or responsibility for the quality or functionality of a repaired device





en



## Sequence of assembly

Picture	Symbol	Item	Torque:	Comments
<b>1</b>	 1	1	3±0.5 Nm	Ensure accurate torque at all screws before next step.
<b>1</b>	 2	18	31±3 Nm	Ensure accurate torque at all screws before next step.
<b>1</b>	 3	37	8±1 Nm	Ensure accurate torque at all screws before next step.
<b>1</b>	 1			Lubricate sealing and sliding surfaces.100919910
<b>1</b>	 2	11,14		Assemble ungreased!
<b>2</b>	 3	13		Prior to assembly, slit the ring open (without burr). Make sure that after installation the slot has the same dimension as prior to installation.

es

## Símbolos & Palabras de aviso







-  **DANGER** PELIGRO Situación de peligro inminente: Pueden ocasionarse daños personales graves o incluso mortales
-  **WARNING** CUIDADO Posible situación de peligro: Pueden ocasionarse daños personales leves o moderados o pérdidas materiales
-  **CAUTION** ADVERTENCIA Posible situación de peligro: Pueden ocasionarse daños personales graves o incluso mortales
-  Los componentes incluidos en el kit son los números que aparecen con círculo.

-  Instrucciones/Información para una correcta reparación
-  El kit puede ser utilizado en los equipos que aparecen en la tabla.
-  Los cierres deben apretarse con un par de apriete determinado.
- NOTE** Instrucciones/Información para una correcta reparación

## Consejos generales de reparación





1. Sólo el personal cualificado de un taller especializado está autorizado para realizar las tareas de reparación en los sistemas de seguridad de los vehículos.
3. Siga las regulaciones y normas acerca de prevención de riesgos laborales de su empresa y de su país.
5. Comience la reparación sólo cuando haya leído y comprendido las instrucciones de reparación. Documentos adicionales necesarios: Instrucciones de comprobación, listas de despiece, consejos generales de comprobación y reparación (815 040 109 3), los cuales pueden encontrarse en [www.wabco-auto.com](http://www.wabco-auto.com), introduciendo la referencia del aparato o la referencia de la publicación en la aplicación INFORM.
7. WABCO no asume garantía alguna por el funcionamiento o calidad de un equipo reparado.
2. Atenerse exactamente a las indicaciones e instrucciones del fabricante del vehículo.
4. Utilice piezas de repuesto suministradas por WABCO o el fabricante del vehículo.
6. Compruebe la eficacia de funcionamiento y de ajuste de cada equipo reparado en unas instalaciones adecuadas según las instrucciones de comprobación.

## Montaje sucesión

Dibujo	Símbolo	Posición	Par de apriete:	Observaciones
<b>1</b>	 1	1	3±0.5 Nm	Asegurese de aplicar el par de apriete adecuado en todos los tornillos antes de pasar al siguiente punto.
<b>1</b>	 2	18	31±3 Nm	Asegurese de aplicar el par de apriete adecuado en todos los tornillos antes de pasar al siguiente punto.
<b>1</b>	 3	37	8±1 Nm	Asegurese de aplicar el par de apriete adecuado en todos los tornillos antes de pasar al siguiente punto.
<b>1</b>	 1			Las juntas y las superficies deslizantes deben lubricarse.100919910
<b>1</b>	 2	11,14		¡Montar sin engrasar!
<b>2</b>	 3	13		Realice un corte en el anillo antes del montaje (sin rebabas). Asegúrese de la medida de la ranura es idéntica antes y después del montaje.

fr

## Symboles & Significations

-  **DANGER** DANGER Situation de danger imminent : Danger de mort ou de dommage corporel sérieux.
-  **WARNING** ATTENTION Situation de danger probable : Risque de dommage corporel mineur ou modéré ou perte de matériel.
-  **CAUTION** AVERTISSEMENT Situation de danger de danger probable : Danger de mort ou de dommages corporel sérieux
-  Les composants avec repères entourés sont inclus dans le kit.

 Instruction/Information pour une réparation correcte

 Le kit peut être utilisé pour les appareils indiqués sur le Feuille.













 Les fixations doivent être serrées à un couple spécifique.

**NOTE** Instruction/Information pour une réparation correcte

## Conseils généraux de réparation





1. Uniquement le personnel qualifié d'un atelier agréé WABCO est autorisé à effectuer la réparation sur les systèmes de sécurité d'un véhicule.
3. Veillez aux règlements de prévention des accidents indiqués par votre société et aux règlements nationaux.
5. Commencez toujours le travail de réparation seulement après avoir lu et compris toutes les informations indiquées pour la réparation. Documentation complémentaire nécessaire : Instruction d'essai, liste des pièces détachées, instructions de réparation et conseils d'essai (815 030 109 3) en tapant la référence du produit ou le numéro de la publication dans INFORM sur internet : [www.wabco-auto.com](http://www.wabco-auto.com)
7. WABCO n'assume aucune garantie quant au fonctionnement ou à la qualité d'un appareil réparé.
2. Respecter toujours les prescriptions et instructions du constructeur du véhicule.
4. Employez seulement les pièces de rechange WABCO ou du constructeur du véhicule.
6. Examinez chaque appareil réparé pour s'assurer de l'efficacité fonctionnelle et de l'étanchéité selon l'instruction d'essai.

## Les montages ordre

Image	Symbole	Position	Couple de serrage:	Remarques
	 1	1	3±0.5 Nm	Assurez-vous d'un couple correct à toutes les vis avant l'étape suivante
	 2	18	31±3 Nm	Assurez-vous d'un couple correct à toutes les vis avant l'étape suivante
	 3	37	8±1 Nm	Assurez-vous d'un couple correct à toutes les vis avant l'étape suivante
	 1			Les surfaces d'étanchéité et de frottement doivent être graissées.100919910
	 2	11,14		Dégraisser l'ensemble
	 3	13		Couper la bague avant montage (sans bavures). S'assurer que la dimension de la fente est identique avant et après le montage.

hr

## Simboli & Značenja

-  **DANGER** OPREZ Neposredna rizična situacija: moguće ozbiljno ozljeđivanje ili smrt
-  **WARNING** OPASNOST neposredna rizična situacija: moguće manje ozljeđivanje materijalna šteta
-  **CAUTION** UPOZORENJE Neposredna rizična situacija: moguće ozbiljno ozljeđivanje ili smrt
-  Dijelovi uređaja čiji su brojevi zaokruženi nalaze se u kompletu..

 Informacija o ispravnom popravku.

 Set može biti korišten za uređaje prema tabeli.

 Spone moraju biti stegnute prema specifičnim silama zatezanja.







**NOTE** Informacija o ispravnom popravku.

hr

## Opće upute o popravcima





1. Samo kvalificirane osobe istručnjaci smiju popravljati siguronosne sustave na vozilu.
3. Provodi tvrtkine siguronosne propise kao i nacionalne propise o sigurnosti
5. Popravak počni tek nakon što pročitaš i shvatiš upute o popravku. Potrebni dokumenti: Instrukcije o testiranju, Lista rezervnih dijelova, Opće natuknice o popravku i testiranju (815 010 109 3) mogu se naći na [www.wabco-auto.com](http://www.wabco-auto.com) nakon upisa kataložnog broja proizvoda ili publikacije u INFORM-u.
7. WABCO ne preuzima odgovornost za rad i kvalitetu popravljenog uređaja.
2. U potpunosti slijedi specifikacije i upute proizvođača vozila.
4. Koristi rezervne dijelove proizvedene od WABCA ili proizvođača vozila..
6. Provjeri svaki popravljeni uređaj kako radi i da li je zategnuto sve kako treba prema odgovarajućim uputama o testiranju proizvoda.



## Redosljed ugradnje

Slika	Simbol	Pojedinost	Zakretni moment:	Komentar
<b>1</b>	 1	1	3±0.5 Nm	Provjeri da su vijci stegnuti ispravno odgovarajućom silom zatezanja prije slijedećeg koraka
<b>1</b>	 2	18	31±3 Nm	Provjeri da su vijci stegnuti ispravno odgovarajućom silom zatezanja prije slijedećeg koraka
<b>1</b>	 3	37	8±1 Nm	Provjeri da su vijci stegnuti ispravno odgovarajućom silom zatezanja prije slijedećeg koraka
<b>1</b>	 1			Brtvene i klizne površine treba podmazati.100919910
<b>1</b>	 2	11,14		Dio mora biti ugrađen suh, nepodmazan.!
<b>2</b>	 3	13		Prerežite prsten prije montaže (bez grebena). Osigurajte da veličina proreza bude jednaka prije i nakon ugradnje.

it

## Simboli e Segnali

-  **DANGER** PERICOLO Imminente situazione di rischio: serie ferite personali fino anche alle morte
-  **WARNING** PRUDENZA Possibili situazioni di pericolo: possibili lievi ferite o perdita di materiale
-  **CAUTION** AVVERTENZA Possibili situazioni di pericolo: serie ferite personali fino anche alle morte
-  I componenti indicati con un numero cerchiato, sono inclusi nel kit.







-  Istruzioni/Informazioni per unacorretta riparazione
-  Il kit può essere usato per gli articoli secondo la tabella.
-  I fissaggi devono essere stretti ad una coppia di serraggio specifica.
- NOTE** Istruzioni/Informazioni per unacorretta riparazione

## Suggerimenti per la riparazione

1. Soltanto il personale qualificato delle officine specializzate è autorizzato ad effettuare le riparazioni sui sistemi di sicurezza dei veicoli.
3. Attenersi alle norme nazionali e aziendali in merito alla prevenzione degli infortuni.
5. Effettuare la riparazione solamente dopo aver letto e capito tutte le informazioni richieste per la riparazione. Ulteriori informazioni necessarie: istruzioni di collaudo, catalogo dei ricambi, cenni generali sulla riparazione e test (815 050 109 3) possono essere trovati sul sito [www.wabco-auto.com](http://www.wabco-auto.com) alla voce INFORM entrando per codice del dell'apparecchio o per numero della pubblicazione.
7. WABCO non si assume alcuna responsabilità per il funzionamento o la qualità di un apparecchio riparato.
2. E' assolutamente necessario seguire le istruzioni e le specifiche del costruttore del veicolo.
4. Usare solo ricambi originali WABCO o del costruttore del veicolo.
6. Controllare la funzionalità e l'efficienza di ogni apparecchiatura riparata secondo le istruzioni riportate nel manuale di collaudo.





it



## Sequenza di montaggio

Figura	Simbolo	Particolare	Coppia di serraggio:	Note
<b>1</b>	 1	1	3±0.5 Nm	Assicurarsi prima dell'operazione di lavoro successiva che tutte le viti abbiano la corretta coppia di serraggio.
<b>1</b>	 2	18	31±3 Nm	Assicurarsi prima dell'operazione di lavoro successiva che tutte le viti abbiano la corretta coppia di serraggio.
<b>1</b>	 3	37	8±1 Nm	Assicurarsi prima dell'operazione di lavoro successiva che tutte le viti abbiano la corretta coppia di serraggio.
<b>1</b>	 1			Superfici di tenuta e di scorrimento devono essere lubrificate. 100919910
<b>1</b>	 2	11,14		Impiegare senza grasso!
<b>2</b>	 3	13		Tagliare l'anello prima del montaggio (senza bavatura). Assicurarsi che la misura della fessura sia identica prima e dopo il montaggio.

nl

## Symbolen & trefwoorden







-  **DANGER** RISICO Direct gevaarlijke situatie: ernstig lichamelijk letsel of dood als gevolg
-  **WARNING** VOORZICHTIG Mogelijk gevaarlijke situatie: licht of middelmatig lichamelijk letsel of verlies van materiaal als gevolg.
-  **CAUTION** WAARSCHUWING Mogelijk gevaarlijke situatie: ernstig lichamelijk letsel of dood als gevolg
-  Componenten met een omcirkeld itemnummer zitten in de reparatieset.

-  Instructie/informatie voor reparatie op de juiste wijze
-  De reparatieset kan voor de componenten volgens de tabel worden gebruikt..
-  Bevestigingsmateriaal met aangegeven aanhaalmoment aantrekken.
- NOTE** Instructie/informatie voor reparatie op de juiste wijze

## Algemene reparatieaanwijzingen

1. Alleen gekwalificeerd personeel van een gespecialiseerde werkplaats is bevoegd reparatiewerkzaamheden uit te voeren aan componenten van voertuig-veiligheidssystemen.
3. Houdt u ter voorkoming van ongevallen aan de voorschriften van zowel het bedrijf als de overheid.
5. Begin reparatiewerkzaamheden altijd pas nadat u alle benodigde informatie heeft gelezen en begrepen. Benodigde documenten: Testvoorschriften, onderdelenlijst, algemene reparatie- en testaanwijzingen (815 010 109 3), die u kan vinden op [www.wabco-auto.com](http://www.wabco-auto.com) door het productnummer of publicatienummer in te geven in INFORM
7. WABCO aanvaardt geen aansprakelijkheid of verantwoordelijkheid voor het functioneren en de kwaliteit van een gerepareerd apparaat.
2. Volg de richtlijnen en aanwijzingen van de voertuigfabrikant onvoorwaardelijk op.
4. Gebruik uitsluitend vervangingsdelen die door WABCO of de voertuigfabrikant zijn vrijgegeven.
6. Controleer elk gerepareerd component - volgens de testinstructies - op een testbank of soortgelijke installatie op juiste afstelling, werking en dichtheid.





## Volgorde van montage

Afbeelding	Symbol	Positie	Aanhaalmoment:	Opmerking
<b>1</b>	 1	1	3±0.5 Nm	Controleer voor de volgende stap, dat alle schroeven goed zijn aangedraaid.
<b>1</b>	 2	18	31±3 Nm	Controleer voor de volgende stap, dat alle schroeven goed zijn aangedraaid.
<b>1</b>	 3	37	8±1 Nm	Controleer voor de volgende stap, dat alle schroeven goed zijn aangedraaid.
<b>1</b>	 1			Afdichtings- en glijvlakken moeten worden gesmeerd. 100919910
<b>1</b>	 2	11,14		Zonder smering monteren!
<b>2</b>	 3	13		Splijt de ring voor de montage (zonder braam). Zorg ervoor dat de spleet voor en na montage even groot is.





pl

## Hasła ostrzegawcze i symbole

-  **DANGER** NIEBEZPIECZEŃSTWO Bezpośrednie zagrożenie ciężkimi obrażeniami bądź śmiercią.
-  **WARNING** UWAGA! Niebezpieczeństwo grożące lekkimi bądź średnimi obrażeniami.
-  **CAUTION** OSTRZEŻENIE Niebezpieczeństwo grożące śmiercią bądź ciężkimi obrażeniami.
-  Części oznaczone kółkiem wokół numeru pozycji należą do zestawu naprawczego.

 Wskazówki / Informacje dotyczące poprawnej naprawy.

 Zestaw naprawczy może być używany do urządzeń według tabeli.













 Dokręcić element podanym momentem obrotowym.

**NOTE** Wskazówki / Informacje dotyczące poprawnej naprawy.

## Ogólne porady naprawcze





1. Prace naprawcze w obrębie urządzeń układu bezpieczeństwa pojazdu mogą być wykonane jedynie przez wykwalifikowany personel specjalistycznego warsztatu.
3. Należy przestrzegać zakładowych i krajowych przepisów BHP.
5. Naprawę należy rozpocząć dopiero wówczas, gdy wszystkie potrzebne do niej informacje zostaną przeczytane i zrozumiane. Dokumenty potrzebne dodatkowo: instrukcja kontrolna, tabela części zamiennych, ogólne wskazówki dotyczące naprawy i kontroli (815 020 109 3) znajdują Państwo na stronie internetowej [www.wabco-auto.com](http://www.wabco-auto.com), podając numer urządzenia bądź numer publikacji w bazie INFORM.
7. WABCO nie udziela żadnej gwarancji na działanie lub jakość naprawionego urządzenia.
2. Należy koniecznie postępować według wytycznych i wskazówek producenta pojazdu.
4. Należy używać wyłącznie części zamiennych dopuszczonych przez firmę WABCO bądź przez producenta pojazdu.
6. Na odpowiednim urządzeniu należy sprawdzić każde naprawiane urządzenie - zgodnie z instrukcją kontrolną - pod kątem sprawności działania i szczelności.

## Kolejność montażu

Obraz	Symbol	Pozycja	Moment dokręcania:	Komentarz
	 1	1	3±0.5 Nm	Sprawdź właściwy moment we wszystkich śrubach przed przystąpieniem do następnego kroku.
	 2	18	31±3 Nm	Sprawdź właściwy moment we wszystkich śrubach przed przystąpieniem do następnego kroku.
	 3	37	8±1 Nm	Sprawdź właściwy moment we wszystkich śrubach przed przystąpieniem do następnego kroku.
	 1			Należy nasmarować powierzchnie uszczelniające i ślizgowe.100919910
	 2	11,14		Zmontować bez smaru.
	 3	13		Przed montażem naciąć pierścieni (bez zadziórów). Upewnić się, że wymiar szczeliny przed i po montażu jest identyczny.

ru

## Знаки & символы

-  **DANGER** ОПАСНО Прямая угроза аварийной ситуации: влечет за собой смерть или тяжелые повреждения
-  **WARNING** ОСТОРОЖНО Опасная ситуация: последствиями являются легкие повреждения или повреждения средней тяжести, а также материальный ущерб
-  **CAUTION** ПРЕДУПРЕЖДЕНИЕ Опасная ситуация: влечет за собой смерть или тяжелые повреждения
-  Номера частей, обведенные кружком, Вы найдете в ремкомплекте.

 Указание/информация для проведения надлежащего ремонта

 Ремкомплект может быть использован для приборов соответственно таблице.

 Элемент необходимо подтянуть с помощью заданного момента сопротивления.













**NOTE** Указание/информация для проведения надлежащего ремонта

ru

## Общие указания по ремонту





1. Провождение ремонта приборов данной системы должно производиться только квалифицированным персоналом в специализированной мастерской.
3. Соблюдайте предписания предприятия по технике безопасности, а также национальные нормы.
5. Проводите ремонт только после того, как вы прочитали и поняли все информации, необходимые для данного процесса. Дополнительные документы: инструкция по тестированию, список запасных частей, общие инструкции по ремонту и проведению испытаний (815 080 109 3) Вы найдете на [www.wabco-auto.com](http://www.wabco-auto.com). Для этого необходимо задать номер нужного прибора или номер брошюры в INFORM.
7. Компания WABCO не принимает на себя какую-либо ответственность за работу или качество отремонтированных устройств.
2. Следуйте предписаниям и инструкциям изготовителя транспортного средства.
4. Используйте только запчасти, допущенные к использованию компанией Wabco или производителем транспортного средства.
6. Проконтролируйте каждый отремонтированный прибор- согласно инструкции по тестированию- на работоспособность и герметичность с помощью соответствующего оборудования.



## Порядок действий при монтаже.

Изображение	Символ	Позиция	Момент сопротивления:	Замечания
	 1	1	3±0.5 Nm	Перед следующим этапом работ убедитесь в том, что для всех винтов применен соответствующий момент затяжки.
	 2	18	31±3 Nm	Перед следующим этапом работ убедитесь в том, что для всех винтов применен соответствующий момент затяжки.
	 3	37	8±1 Nm	Перед следующим этапом работ убедитесь в том, что для всех винтов применен соответствующий момент затяжки.
	 1			Смажьте поверхности уплотнения / скольжения.100919910
	 2	11,14		При сборке не смазывать!
	 3	13		Перед монтажом необходимо проделать зазор в кольце (и удалить заусенцы). Размер прорези до и после установки должен оставаться одинаковым.

SV

## Signalord & symboler

-  **DANGER** FARA Omedelbar risk: svåra personskador eller dödsfall
-  **WARNING** VARNING Möjlig risk: Lätta eller medelsvåra personskador eller materiella skador
-  **CAUTION** VARNING Möjlig risksituation: Dödsfall eller svåra personskador
-  Delar med inringat positionsnummer ingår i reparationssetsen.

-  Anvisningar/information för korrekt reparation
-  Reparationssatsen kan användas för apparater enligt tabellen.
-  Dra åt elementet med angivet åtdragningsmoment.







**NOTE** Anvisningar/information för korrekt reparation

## Allmänna reparationsanvisningar

1. Reparationsarbeten på enheter i fordonssäkerhetssystem får endast genomföras av kvalificerad personal på behörig verkstad.
3. Följ alltid företagets föreskrifter för förebyggande av olycksfall samt gällande nationella föreskrifter.
5. Börja inte med reparationsarbetena förrän du har läst igenom och förstått all nödvändig information. Nödvändiga extradokument: Kontrollanvisning, reservdelsblad, allmän reparation och kontrollinformation (815 070 109 3). Du hittar dokumenten på [www.wabco-auto.com](http://www.wabco-auto.com) genom att mata in apparatens produktnummer eller dokumentnummer i INFORM.
7. WABCO ansvarar inte för reparerade enheters funktion eller kvalitet.
2. Beakta alltid fordonstillverkarens specifikationer och anvisningar.
4. Används endast reservdelar som är godkända av WABCO eller fordonstillverkaren.
6. Varje reparerad apparat ska kontrolleras på funktionsduglighet och tätthet på en lämplig anordning enligt kontrollanvisningen.





SV



## Ordningsföljd för montering

Bild	Symbol	Position	Åtdragningsmoment:	Kommentar
<b>1</b>	 1	1	3±0.5 Nm	Kontrollera att alla skruvar har rätt åtdragningsmoment innan du går vidare till nästa arbetsmoment.
<b>1</b>	 2	18	31±3 Nm	Kontrollera att alla skruvar har rätt åtdragningsmoment innan du går vidare till nästa arbetsmoment.
<b>1</b>	 3	37	8±1 Nm	Kontrollera att alla skruvar har rätt åtdragningsmoment innan du går vidare till nästa arbetsmoment.
<b>1</b>	 1			Smörj tätnings- och glidytorna.100919910
<b>1</b>	 2	11,14		Sätts i utan fett!
<b>2</b>	 3	13		Skär upp ringen före montering (utan grad). Kontrollera att slitsens mått är det samma före och efter montering.







zh

## Symbols & Signal Words

-  **DANGER** 危险! 直接危险: 导致个人严重伤害或死亡
-  **WARNING** 小心! 可能危险: 导致较小或一般程度人员伤害或物品损失
-  **CAUTION** 警告! 可能危险: 导致个人严重伤害或死亡
-  修包中包含号码带有圆圈的零件。

-  用于正确维修的指导和信息。
-  根据表格所示, 修包可以用于相应的总成维修。
-  紧固件必须根据所指定的力矩上紧。
- NOTE** 用于正确维修的指导和信息。

1. 只有在专业维修店的有资质的人员被授权执行车辆安全系统的维修工作。
3. 遵循公司的相关事故预防条例和国家法规。
5. 当你已经阅读并已理解维修所需要的所有信息后, 才能开始维修工作。此外需要的信息: 试验指导, 备件清单, 通用维修和试验提示 (815 010 109 3) 可以在www.wabco-auto.com 找到。只需在其上键入产品号码或INFORM中的出版物号码。
7. WABCO对经过修理的设备的功能或质量不承担任何责任。
2. 完全遵循车辆制造商的规格和安装指导。
4. 仅使用于由威伯科公司或整车制造商发布的备件产品。
6. 根据试验要求在适当的设备上, 检测每个维修设备的功效和紧密性。

图片	符号	零件	扭矩:	注释
<b>1</b>	 1	1	3±0.5 Nm	请在进行下一步工作前确证所有螺钉均具有正确的拧紧力矩。
<b>1</b>	 2	18	31±3 Nm	请在进行下一步工作前确证所有螺钉均具有正确的拧紧力矩。
<b>1</b>	 3	37	8±1 Nm	请在进行下一步工作前确证所有螺钉均具有正确的拧紧力矩。
<b>1</b>	 1			密封和滑动表面必须被润滑。100919910
<b>1</b>	 2	11,14		请不要涂抹油脂装入!
<b>2</b>	 3	13		请在安装前将环开口(无毛刺)。请确保开口尺寸在装入前后一致。

el

## Προειδοποιητικές λέξεις &amp; Σύμβολα

- ⚠ DANGER** ΚΙΝΔΥΝΟΣ! Άμεσα επαπειλούμενος κίνδυνος: Σοβαρές σωματικές βλάβες ή θάνατος
- ⚠ WARNING** ΠΡΟΣΟΧΗ! Πιθανή επικίνδυνη κατάσταση: Ελαφρές ή μεσαίας έκτασης σωματικές βλάβες ή υλικές βλάβες
- ⚠ CAUTION** ΠΡΟΕΙΔΟΠΟΙΗΣΗ! Πιθανή επικίνδυνη κατάσταση: Θάνατος ή σοβαρές σωματικές βλάβες
- Εξαρτήματα με έναν κύκλο γύρω από τον αριθμό θέσης περιλαμβάνονται στο kit επισκευής.

- i** Οδηγίες / πληροφορίες για την ορθή επισκευή
- 📖** Το kit επισκευής μπορεί να χρησιμοποιηθεί για συσκευές αναλόγως του πίνακα.
- T** Συσφίξτε το στοιχείο με την ενδεικτική ροπή στρέψης.

**NOTE** Οδηγίες / πληροφορίες για την ορθή επισκευή

## Γενικές υποδείξεις επισκευής

- Εργασίες επισκευής σε συσκευές ενός συστήματος ασφαλείας οχημάτων επιτρέπονται μόνο από εκπαιδευμένο εξειδικευμένο προσωπικό ειδικού συνεργείου.
- Τηρείτε τους κανονισμούς πρόληψης ατυχημάτων της επιχείρησης, καθώς και τις εθνικές διατάξεις.
- Ξεκινάτε την επισκευή μόνο αφού έχετε αναγνώσει και κατανοήσει όλες τις πληροφορίες που είναι απαραίτητες για την επισκευή. Επιπροσθέτως απαιτούμενα έγγραφα: Οδηγίες ελέγχου, Φύλλο ανταλλακτικών, Γενικές υποδείξεις επισκευής και ελέγχου (815 200 109 3), θα τα βρείτε στη σελίδα [www.wabco-auto.com](http://www.wabco-auto.com), εισάγοντας τον κωδικό προϊόντος της συσκευής και/ή τον αριθμό του εντύπου στον κατάλογο προϊόντων INFORM.
- Η WABCO δεν φέρει καμία ευθύνη για τη λειτουργία ή την ποιότητα μιας επισκευασμένης συσκευής.
- Τηρείτε οπωσδήποτε τις οδηγίες και τις επισημάνσεις του κατασκευαστή του οχήματος.
- Χρησιμοποιείτε αποκλειστικά ανταλλακτικά της WABCO ή του κατασκευαστή του οχήματος.
- Ελέγχετε τη λειτουργικότητα και στεγανότητα κάθε επισκευασμένης συσκευής - σύμφωνα με τις οδηγίες ελέγχου - σε μια κατάλληλη διάταξη.

## Ακολουθία τοποθέτησης

Εικόνα	Σύμβολο	Θέση	Ροπή σύσφιξης:	Παρατηρήσεις
<b>1</b>	<b>T</b> 1	1	3±0.5 Nm	Διασφαλίστε πριν από τη διενέργεια του επόμενου βήματος εργασίας όλες οι βίδες να έχουν συσφιχτεί με τη σωστή ροπή σύσφιξης.
<b>1</b>	<b>T</b> 2	18	31±3 Nm	Διασφαλίστε πριν από τη διενέργεια του επόμενου βήματος εργασίας όλες οι βίδες να έχουν συσφιχτεί με τη σωστή ροπή σύσφιξης.
<b>1</b>	<b>T</b> 3	37	8±1 Nm	Διασφαλίστε πριν από τη διενέργεια του επόμενου βήματος εργασίας όλες οι βίδες να έχουν συσφιχτεί με τη σωστή ροπή σύσφιξης.
<b>1</b>	<b>i</b> 1			Λιπάνετε τις επιφάνειες στεγανοποίησης και ολίσθησης.100919910
<b>1</b>	<b>i</b> 2	11,14		Τοποθετήστε χωρίς να λιπάνετε!
<b>2</b>	<b>i</b> 3	13		Κόψτε το δακτύλιο πριν τη συναρμολόγηση (χωρίς γρέζια). Βεβαιωθείτε ότι το μέγεθος της σχισμής πριν και μετά την τοποθέτηση είναι ίδιο.

tr

## Semboller&amp;belirti sözleri

- ⚠ DANGER** TEHLİKE Tehlikeli durum: ciddi personel yaralanması veya ölüm riski.
- ⚠ WARNING** DİKKAT Tehlike riski: hafif personel yaralanması veya maddi zarar.
- ⚠ CAUTION** UYARI Ciddi personel yaralanması veya ölüm riski.
- Yuvarlak içinde numarası belirtilen parça numaraları kit içerisinde bulunur.

- i** Talimat/ Doğru tamir için bilgi
- 📖** Tabloda belirtilen parçalar için kit kullanılabilir.
- T** Vidalar özel tork değerine kadar sıkılmalıdır.
- NOTE** Talimat/ Doğru tamir için bilgi

tr

**Genel tamir bilgisi**

- Araçaların güvenlik sistemlerinde tamir işlemlerini yalnızca eğitim almış konusunda uzman personeller gerçekleştirebilir.
- Şirket emniyet kuralları ve ulusal regülasyonlarına uyunuz.
- Tamire, tamir işlemi için gerekli olan tüm bilgileri okuyup anladıktan sonra başlayınız. Ayrıca gerekli olan dokümanlar: Test talimatı, yedek parça sayfası, genel tamir ve test bilgileri (815 140 109 3). Tümünü linki altında, online ürün kataloğu INFORM'da cihaza ait ürün numarasını veya baskı numarasını girerek bulabilirsiniz.
- WABCO tamir edilmiş bir cihazın işlevselliği veya kalitesi için hiçbir sorumluluk üstlenmemektedir.
- Araç üretici firma özellikler ve talimatlarına kesinlikle uyunuz.
- Sadece WABCO veya üretici firma tarafından yayınlanan yedek parçaları kullanın.
- Tamir edilmiş her cihazı - test talimatına uygun şekilde - uygun bir donanımla işlevsellik ve sızdırmazlık konusunda kontrol edin.

**Montaj sırası**

Resim	Sembol	Parça	Tork:	Yorumlar
<b>1</b>	<b>T</b> 1	1	3±0.5 Nm	Bir sonraki iş adımıdan önce, tüm civataların doğru torka sahip olduklarından emin olun.
<b>1</b>	<b>T</b> 2	18	31±3 Nm	Bir sonraki iş adımıdan önce, tüm civataların doğru torka sahip olduklarından emin olun.
<b>1</b>	<b>T</b> 3	37	8±1 Nm	Bir sonraki iş adımıdan önce, tüm civataların doğru torka sahip olduklarından emin olun.
<b>1</b>	<b>i</b> 1			Conta ve sürtünme ile çalışan yüzeyler yağlanmalıdır.100919910
<b>1</b>	<b>i</b> 2	11,14		Gres olmadan yerleştirin!
<b>2</b>	<b>i</b> 3	13		Halkayı montajdan önce yarın (çapak bırakmayın). Montaj öncesindeki ve sonrasındaki yarıç ölçüsünün aynı olmasını sağlayın.

hu

**Szimbólumok és Jelző Szavak**

- ⚠ DANGER** Közelgő vészhelyzet: súlyos személyi sérüléshez vagy halálhoz vezethet
- ⚠ WARNING** Lehetséges vészhelyzet: kisebb vagy közepes személyi sérülés vagy anyagi kár keletkezhet
- ⚠ CAUTION** Lehetséges vészhelyzet: súlyos személyi sérüléshez vagy halálhoz vezethet
- Csak azok az alkatrészek amik be vannak karikázva, részei a javítókészletnek.

**i** Utasítás / Információ a helyes szereléshez

**🔧** A javító készlet a táblázatban szereplő egységekhez használható.

**T** A rögzítő elemeket az előít nyomatékkal kell megüzni







**NOTE** Utasítás / Információ a helyes szereléshez

**Általános Javítási Tippek**

- Csak megfelelő végzettségű személy vagy szakműhely van felhatalmazva hogy a jármű biztonsági rendszerén javítást eszközöljön.
- Mindenképpen vegye figyelembe a gyártók vonatkozó balesetvédelmi előírásait és a nemzeti előírásokat is.
- Minden esetben csak akkor kezdjen hozzá a javítási munkához, ha elolvasta és teljesen megértette a javítási utasítást! Ezekre a dokumentumokra lesz még szüksége: Vizsgálati Utasítás, Alkatrészek listája, Általános javítási és vizsgálati tippek (815 010 109 3) amiket a [www.wabco-auto.com](http://www.wabco-auto.com)-on talál meg, a termék vagy a kiadvány cikkszámának begépelésével az INFORM-ba.
- A WABCO nem vállal felelősséget a javított készülékek működéséért és minőségéért.
- Mindenképpen kövesse a jármű gyártójának specifikációját és szerelési utasításait.
- Csak a WABCO vagy a jármű gyártója által kereskedelmi forgalomban lévő alkatrészeket használjon.
- Minden javított egységnél ellenőrizze a működési üzemiállapotokat és az előírt meghúzási nyomatékokat a vizsgálati utasításnak megfelelően.





hu



## Szerelési sorrend

Kép	Szimbolum	Tétel	Nyomaték	Megjegyzés
<b>1</b>	 1	1	3±0.5 Nm	A következő munkalépés előtt győződjön meg arról, hogy minden csavar esetében megfelelő meghúzási nyomatékot alkalmaz.
<b>1</b>	 2	18	31±3 Nm	A következő munkalépés előtt győződjön meg arról, hogy minden csavar esetében megfelelő meghúzási nyomatékot alkalmaz.
<b>1</b>	 3	37	8±1 Nm	A következő munkalépés előtt győződjön meg arról, hogy minden csavar esetében megfelelő meghúzási nyomatékot alkalmaz.
<b>1</b>	 1			A tömítő és csúszó felületeket mindenképp kenni kell. 100919910
<b>1</b>	 2	11,14		Zsír nélküli összeszerelést igényel.
<b>2</b>	 3	13		Szerelés előtt metsze be a gyűrűt (sorja nélkül). Gondoskodjon arról, hogy a hézag a beépítés után ugyanakkora legyen, mint beépítés előtt volt.

pt

## Símbolos e Significados







-  **DANGER** Perigo! Risco de acidente iminente: lesão corporal grave e/ou risco de morte.
-  **WARNING** Cuidado! Possível situação de acidente: ferimentos leves/moderados e/ou danos materiais.
-  **CAUTION** Atenção! Possível situação de acidente: lesão corporal grave e/ou risco de morte.
-  Componentes que estão marcados com um círculo compõem o jogo de reparo.

-  Instrução/Informação para uma correta reparação.
-  O jogo de reparo pode ser utilizado nos produtos relacionados na tabela.
-  Parafusos/porcas devem ser montados de acordo com o torque especificado.
- NOTE** Instrução/Informação para uma correta reparação.

## Dicas Gerais para Reparação





1. Por motivo de segurança, somente pessoas qualificadas devem efetuar reparação nos sistemas de freio do veículo.
3. Mantenha e siga as orientações de prevenção de acidentes vigentes e/ou impostas pelos órgãos competentes.
5. Somente inicie o trabalho de reparação após ler e entender todas as informações necessárias para realizar uma reparação. Documentos adicionais necessários: instrução de teste, lista de peças sobressalentes, dicas gerais de testes e reparação (815 130 109 3) podem ser encontrados no site [www.wabco-auto.com](http://www.wabco-auto.com) ao inserir o número do produto.
7. A WABCO não assume qualquer responsabilidade pela função ou qualidade de um equipamento reparado.
2. Siga sempre as recomendações/especificações do fabricante do veículo.
4. Use somente peças de reposição aprovadas pela WABCO ou pelo fabricante do veículo.
6. Verificar cada produto reparado conforme instruções de teste, utilizando os equipamentos necessários e local adequado.



## Sequência de montagem

Figura	Símbolo	Item	Torque:	Comentários
<b>1</b>	 1	1	3±0.5 Nm	O manuseamento deste componente requer uma proteção contra a descarga eletrostática (ESD).
<b>1</b>	 2	18	31±3 Nm	O manuseamento deste componente requer uma proteção contra a descarga eletrostática (ESD).
<b>1</b>	 3	37	8±1 Nm	O manuseamento deste componente requer uma proteção contra a descarga eletrostática (ESD).
<b>1</b>	 1			Superfícies de vedação e deslizamento devem ser lubrificadas 100919910
<b>1</b>	 2	11,14		Montado sem graxa!
<b>2</b>	 3	13		Corte o anel antes de realizar a montagem (sem rebarba). Certifique-se, de que a medida do corte seja idêntica antes e depois da montagem.

ro

## Simboluri și cuvinte pentru avertizare













-  **DANGER** Situație de pericol iminentă: poate rezulta vătămare corporală gravă sau deces.
-  **WARNING** Posibilă situație de pericol: pot rezulta vătămări corporale minore sau medii sau pagube materiale
-  **CAUTION** Posibilă situație de pericol: poate rezulta vătămare corporală gravă sau deces
-  Piesele cu numărul de articol încercuit sunt incluse în kit.

-  Instrucțiuni / Informare pentru o reparare corectă
-  Kitul poate fi folosit pentru dispozitive, conform tabelului.
-  Elementele de fixare trebuie să fie strânse la un moment specific.
- NOTE** Instrucțiuni / Informare pentru o reparare corectă

## Instrucțiuni generale referitoare la reparație





1. Numai personalul calificat al unui atelier de service specializat este autorizat să efectueze lucrări de reparații pe sistemul de siguranță al vehiculului.
3. Respectați prevederile firmei și cele naționale pentru prevenirea accidentelor.
5. Întotdeauna începeți lucrările de reparații numai după ce ați citit și înțeles toate informațiile necesare pentru reparație. Documente suplimentare necesare: Instrucțiuni de testare, Lista pieselor de schimb, Instrucțiuni generale pentru reparație și testare (815 110 109 3) pot fi găsite pe [www.wabco-auto.com](http://www.wabco-auto.com) introducând codul dispozitivului în INFORM.
7. WABCO nu garantează sau nu răspunde pentru funcționarea și calitatea unui dispozitiv reparat.
2. Respectați obligatoriu instrucțiunile date de producătorul vehiculului.
4. Utilizați exclusiv piese de schimb autorizate de WABCO sau de producătorul autovehiculului.
6. Verifică eficiența funcțională și etanșeitatea fiecărui echipament reparat pe o instalație adecvată în conformitate cu instrucțiunile de testare.



## Secvența asamblării

Imagine	Simbol	Articol	Moment de torsiune:	Comentarii
	 1	1	3±0.5 Nm	Înainte de următoarea etapă de lucru, asigurați-vă că toate șuruburile au momentul de strângere corect.
	 2	18	31±3 Nm	Înainte de următoarea etapă de lucru, asigurați-vă că toate șuruburile au momentul de strângere corect.
	 3	37	8±1 Nm	Înainte de următoarea etapă de lucru, asigurați-vă că toate șuruburile au momentul de strângere corect.
	 1			Suprafețele de etanșare și alunecare trebuie să fie lubrificate.100919910
	 2	11,14		Asamblați fără gresare!
	 3	13		Crestați inelul înainte de montare (fără bavură). Asigurați-vă că dimensiunea fantei este identică înainte și după montare.

ko







## Symbols & Signal Words

-  **DANGER** 급박한 위험 상황: 심각한 상해 또는 사망에 이르게 할 수 있습니다.
-  **WARNING** 잠재적 위험 상황: 경미하거나 완화된 부상 또는 물질적 손실을 입을 수 있습니다.
-  **CAUTION** 잠재적 위험 상황: 심각한 상해 또는 사망에 이르게 할 수 있습니다.
-  본 키트에는 원숫자로 표기된 제품들만 포함되어 있습니다.

-  올바른 수리를 위한 설명 / 정보
-  표를 참조하여 제품에 대한 키트를 사용할 수 있습니다.
-  체결품들은 명시된 토크값으로 체결되어야 합니다.
- NOTE** 올바른 수리를 위한 설명 / 정보

## ko

1. 자격이 있는 전문 정비사만이 차량의 안전 시스템을 수리하실 수 있습니다.
2. 꼭 차량제조사의 사양과 지침서를 따르십시오.
3. 회사의 사고예방 규제와 국내 법적 규제를 지키십시오.
4. 와브코 또는 차량 제조사로부터 제공된 예비부품만을 사용하십시오.
5. 항상 수리에 필요한 모든 정보를 읽고 이해했을 때만 작업을 시작하십시오. 추가적으로 필요한 간행물: 검사지침, 예비부품 리스트, 일반적인 수리 및 검사 참고사항 (815 010 109 3)은 와브코 홈페이지 [www.wabco-auto.com](http://www.wabco-auto.com)의 INFORM으로 들어가셔서 제품번호 또는 간행물 번호를 조회하여 찾으실 수 있습니다.
6. 기능적 효율과 견고함을 위해 검사지침에 따라 각 수리장비들을 적절한 설비위에서 체크해 보시기 바랍니다.
7. 와브코는 수리된 제품의 품질과 기능에 대해 어떠한 책임도 지지 않습니다.

그림	기호	품목	토크:	주석
<b>1</b>	 1	1	3±0.5 Nm	다음 절차를 실행하기 전에 모든 나사에 정확한 토크가 주어졌는지 확인하십시오.
<b>1</b>	 2	18	31±3 Nm	다음 절차를 실행하기 전에 모든 나사에 정확한 토크가 주어졌는지 확인하십시오.
<b>1</b>	 3	37	8±1 Nm	다음 절차를 실행하기 전에 모든 나사에 정확한 토크가 주어졌는지 확인하십시오.
<b>1</b>	 1			밀폐되어 미끄러져 움직이는 부위의 표면에는 윤활제를 도포하십시오.100919910
<b>1</b>	 2	11,14		구리스를 바르지 말고 조립하십시오.
<b>2</b>	 3	13		조립하기 전에 링에 길게 흠을 내십시오(버 없음). 슬롯의 치수가 설치 전후에 일치하도록 하십시오