

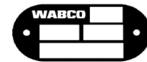

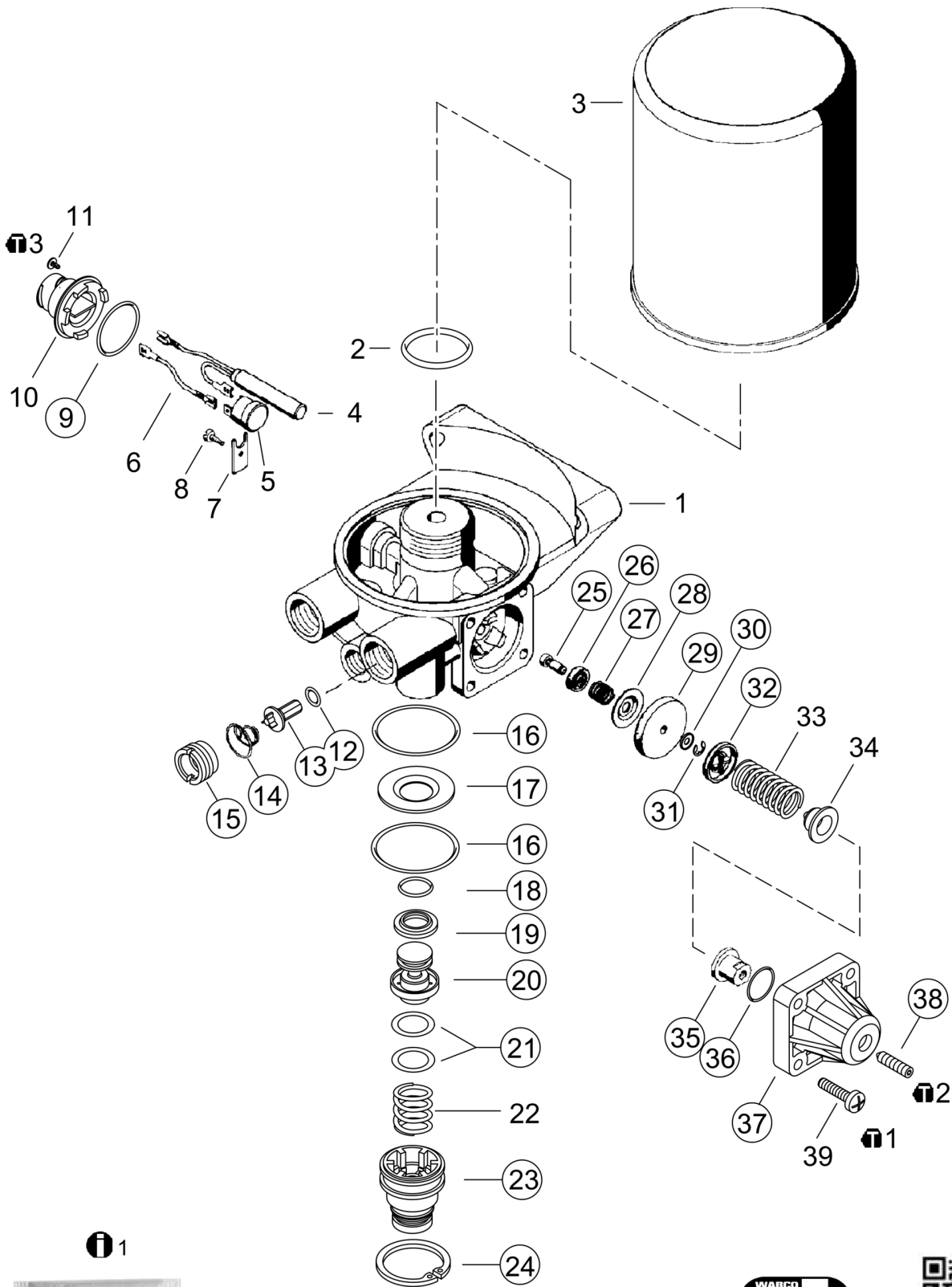

1





<http://www.wabco.info/i/539>

de

Signalwörter & Symbole









-  **DANGER** GEFAHR Unmittelbar drohende Gefährdung: Schwere Personenschäden oder Tod
-  **WARNING** WARNUNG Mögliche Gefahrensituation: Tod oder schwere Personenschäden als Folge
-  **CAUTION** VORSICHT Mögliche Gefahrensituation: Leichte oder mittelschwere Personenschäden oder Sachschäden als Folge
-  Teile mit Kreis um die Positionsnummer sind im Reparatursatz enthalten.

-  Anweisung / Information für eine korrekte Reparatur
-  Der Reparatursatz kann für Geräte entsprechend Tabelle verwendet werden.
-  Element mit angegebenen Drehmoment bzw. Drehwinkel anziehen.

Allgemeine Reparaturhinweise





1. Reparaturarbeiten an Geräten eines Fahrzeug-Sicherheitssystems darf nur qualifiziertes Personal einer Fachwerkstatt durchführen.
3. Halten Sie Unfallverhütungsvorschriften des Betriebes sowie nationale Vorschriften ein.
5. Beginnen Sie die Reparatur erst dann, wenn Sie alle Informationen, die für die Reparatur notwendig sind, gelesen und verstanden haben. Zusätzlich benötigte Dokumente: Prüfanweisung, Ersatzteilblatt, Allgemeine Reparatur- und Prüfhinweise (815 020 109 3) zu finden auf www.wabco-auto.com mittels Eingabe der Produktnummer des Gerätes bzw. Druckschriftennummer in INFORM.
2. Leisten Sie den Vorgaben und Anweisungen des Fahrzeugherstellers unbedingt Folge.
4. Verwenden Sie ausschließlich von WABCO oder vom Fahrzeughersteller freigegebene Ersatzteile.
6. Prüfen Sie jedes reparierte Gerät – gemäß Prüfanweisung – an einer adäquaten Einrichtung auf Funktionstüchtigkeit und Dichtigkeit.



Montage Reihenfolge

Bild	Symbol	Position	Wert	Hinweis
				Fetten Sie die Dicht- und Gleitflächen ein. 830 502 076 4
	 1	39	M = 3 + 2 / 0 Nm	
	 2	38	M = 5 + 0 / -4 Nm	
	 3	11	M max = 5 Nm	

en

Symbols & Signal Words

-  **DANGER** Imminent hazard situation: serious personal injury or death as a result
-  **WARNING** Possible hazard situation: serious personal injury or death as a result
-  **CAUTION** Possible hazard situation: minor or moderate personal injury or material loss as a result
-  Parts having item numbers with circles are included in the kit.









-  Instruction / Information for a correct repair
-  The kit can be used for devices according table.
-  Tighten element with specified torque or angle of rotation.

General Repair Hints

1. Only qualified personnel of a specialist workshop are authorized to perform repair work on a vehicle's security system.
3. Keep to company's relevant accident prevention regulations and national regulations.
5. Always start repair work only when you have read and understood all information required for repair. Documents additionally needed: Test Instruction, Spare Parts List, General Repair and Test Hints (815 010 109 3) to be found on www.wabco-auto.com by entering product number of the device or the publication number in INFORM.
2. Absolutely follow specifications and instructions of vehicle manufacturer.
4. Use only spare parts released by WABCO or vehicle manufacturer.
6. Check each repaired equipment for functional efficiency and tightness on an adequate facility according to the test instruction.





en



Sequence of assembly

Picture	Symbol	Item	Value	Hint
				Lubricate sealing and sliding surfaces. 830 502 076 4
	 1	39	M = 3 + 2 / 0 Nm	
	 2	38	M = 5 + 0 / -4 Nm	
	 3	11	M max = 5 Nm	









zh

Symbols & Signal Words

-  **DANGER** 危险! 直接危险: 导致个人严重伤害或死亡
-  **WARNING** 警告! 可能危险: 导致个人严重伤害或死亡
-  **CAUTION** 小心! 可能危险: 导致较小或一般程度人员伤害或物品损失
-  修包中包含号码带有圆圈的零件。





-  用于正确维修的指导 and 信息。
-  根据表格所示, 修包可以用于相应的总成维修。
-  用给定的扭矩及转角上紧元件。



1. 仅在专业维修店的有资质的人员被授权执行车辆安全系统的维修工作。
2. 完全遵循车辆制造商的规格和安装指导。
3. 遵循公司的相关事故预防条例和国家法规。
4. 仅使用于由威伯科公司或整车制造商发布的备件产品。
5. 当你已经阅读并理解维修所需要的所有信息后, 才能开始维修工作。此外需要的信息: 试验指导, 备件清单, 通用维修和试验提示 (815 010 109 3) 可以在 www.wabco-auto.com 找到。只需在其上键入产品号码或INFORM中的出版物号码。
6. 根据试验要求在适当的设备上, 检测每个维修设备的功效和紧密性。

图片	符号	零件	价值	提示
				密封和滑动表面必须被润滑。830 502 076 4
	 1	39	M = 3 + 2 / 0 Nm	
	 2	38	M = 5 + 0 / -4 Nm	
	 3	11	M max = 5 Nm	

ko

Symbols & Signal Words

-  **DANGER** 급박한 위험 상황: 심각한 상해 또는 사망에 이르게 할 수도 있습니다.
-  **WARNING** 잠재적 위험 상황: 심각한 상해 또는 사망에 이르게 할 수도 있습니다.
-  **CAUTION** 잠재적 위험 상황: 경미하거나 완화된 부상 또는 물질적 손실을 입을 수 있습니다.
-  본 키트에는 원숫자로 표기된 제품들만 포함되어 있습니다.

-  올바른 수리를 위한 설명 / 정보
-  표를 참조하여 제품에 대한 키트를 사용할 수 있습니다.
-  제시된 토크 및 회전각으로 요소를 조이십시오.

ko

1. 자격이 있는 전문 정비사만이 차량의 안전 시스템을 수리하실 수 있습니다.
2. 꼭 차량제조사의 사양과 지침서를 따르십시오.
3. 회사의 사고예방 규제와 국내 법적 규제를 지키십시오.
4. 와브코 또는 차량 제조사로부터 제공된 예비부품만을 사용하십시오.
5. 항상 수리에 필요한 모든 정보를 읽고 이해했을 때만 작업을 시작하십시오. 추가적으로 필요한 간행물: 검사지침, 예비부품 리스트, 일반적인 수리 및 검사 참고사항 (815 010 109 3)은 와브코 홈페이지 www.wabco-auto.com의 INFORM으로 들어가셔서 제품번호 또는 간행물 번호를 조회하여 찾으실 수 있습니다.
6. 기능적 효율과 견고함을 위해 검사지침에 따라 각 수리장비들을 적절한 설비위에서 체크해 보시기 바랍니다.

그림	기호	품목	값	참고사항
1	i			밀폐되어 미끄러져 움직이는 부위의 표면에는 윤활제를 도포하십시오. 830 502 076 4
1	T 1	39	M = 3 + 2 / 0 Nm	
1	T 2	38	M = 5 + 0 / -4 Nm	
1	T 3	11	M max = 5 Nm	