

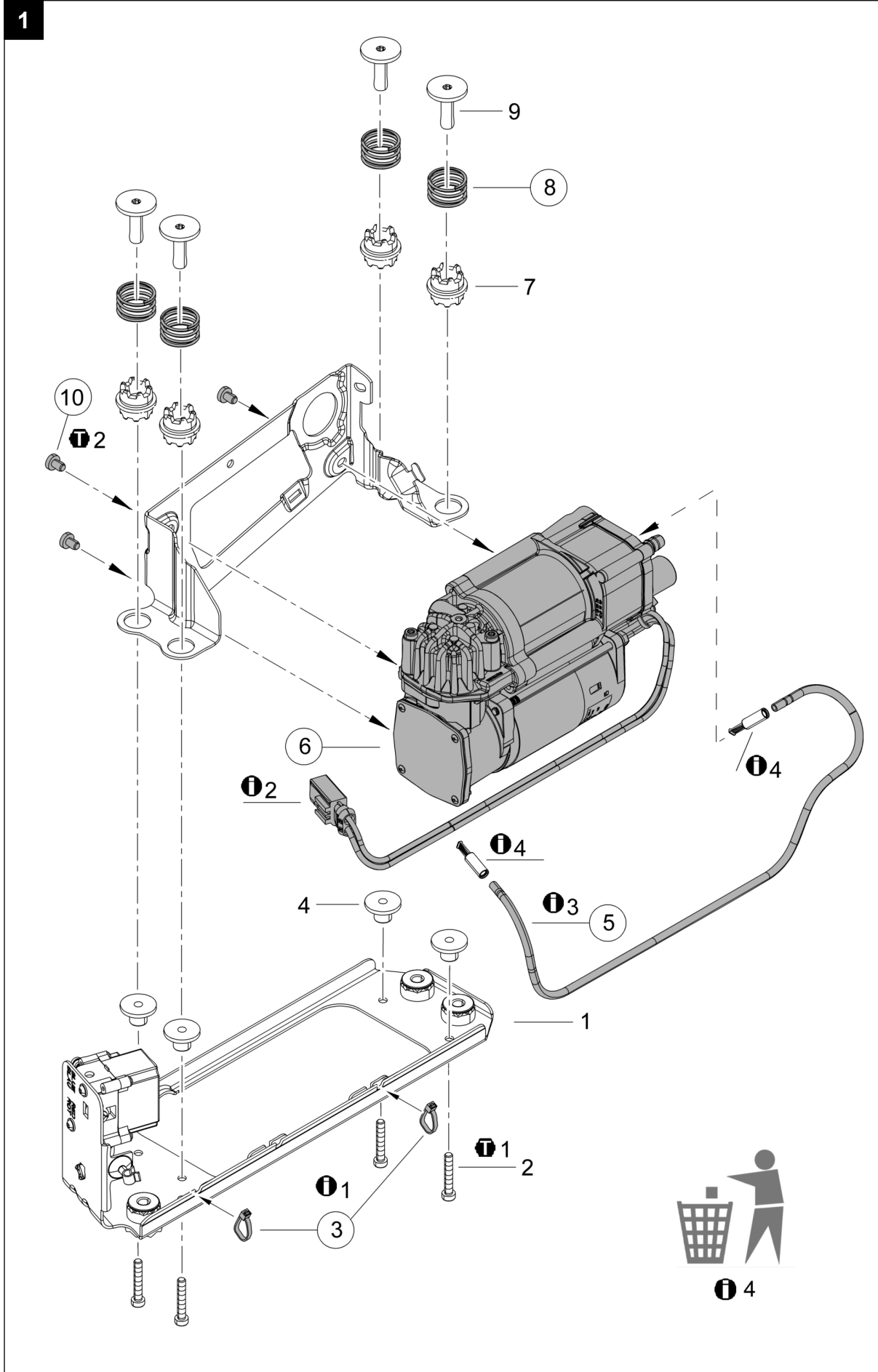

415 403 424 0

1



2

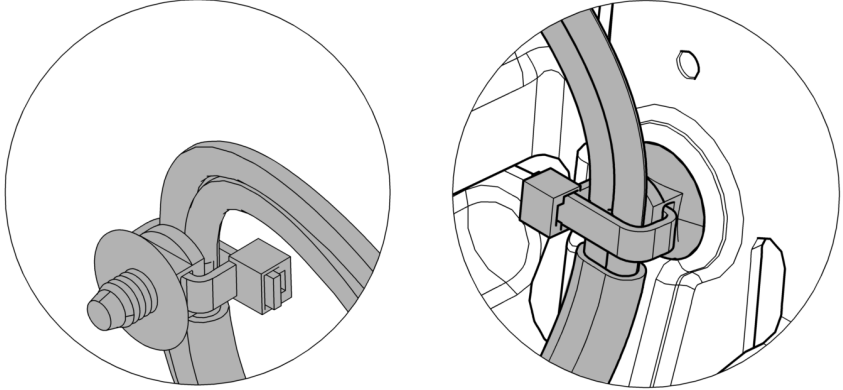

i 5



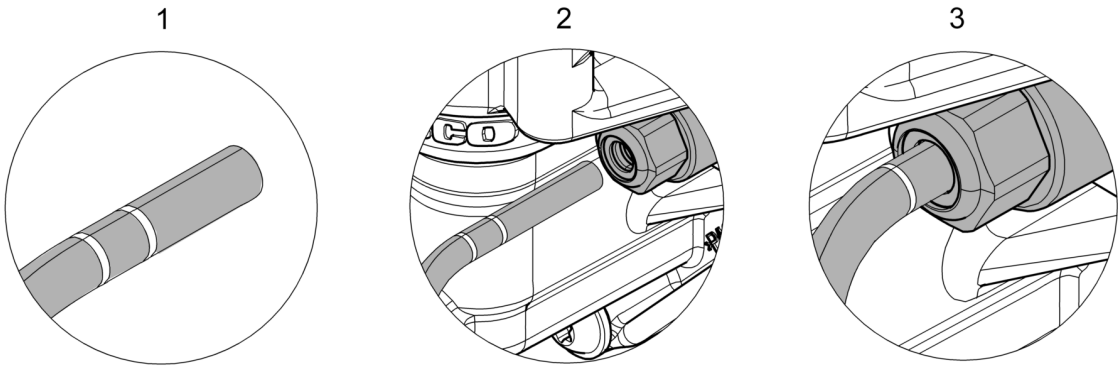

3





i 6

CS

Signální slova a symboly

-  **DANGER** NEBEZPEČÍ Bezprostředně hrozící nebezpečí: těžká újma na zdraví nebo smrt
 -  **WARNING** POZOR Možná nebezpečná situace: jako následek lehká nebo středně těžká újma na zdraví nebo poškození majetku
 -  **CAUTION** VÝSTRAHA Možná nebezpečná situace: jako následek těžká újma na zdraví nebo smrt
-  Díly, které mají číslo pozice v kroužku, jsou obsažené v opravárenské sadě.

-  Instrukce / informace ke správnému provedení opravy
-  Opravárenskou sadu je možné použít pro přístroje uvedené v tabulce.
-  Prvek utáhněte uvedeným točivým momentem příp. pomocí kontroly úhlu natočení.









Všeobecné pokyny k opravám

1. Opravárenské práce na přístrojích systému, který má vliv na bezpečnost vozidla, smí provádět pouze kvalifikovaný personál odborné servisní dílny.
3. Dodržujte předpisy BOZP podniku a národní předpisy.
5. S opravou začněte teprve tehdy, až všechny informace nutné pro opravu přečtete a porozumíte jim. Další potřebné dokumenty: zkušební postup, list náhradních dílů, všeobecné pokyny pro opravu a kontrolu (815 150 109 3) naleznete na internetových stránkách: www.wabco-auto.com, když v databázi INFORM zadáte produktové číslo přístroje nebo číslo dokumentu.
7. WABCO nepřebírá žádnou záruku za funkci nebo kvalitu opraveného přístroje.
2. Postupujte bezpodmínečně podle pokynů a instrukcí výrobce vozidla.
4. Používejte výhradně náhradní díly od firmy WABCO nebo díly schválené výrobcem vozidla.
6. Na adekvátním zařízení přezkoušejte – podle zkušebního postupu – každý opravený přístroj na funkčnost a těsnost.

Instrukce





- Umístěte vozidlo na podstavnou stoliči.
- Odpojte soustavu od elektrického napájení a zcela ji odvdzdušněte.



Návod k montáži

Obrázek	Symbol	Pozice	Hodnota	Instrukce
	 1	2	7 ± 1 Nm	
	 2	8	9 + 2 / - 0 Nm	
	 1, 5	3		Umístěte na značku.
	 2			Zkontrolujte, jestli jsou správně zapojena všechna pneumatická a elektrická vedení.
	 3	5		Pozor! Vedení může být pod tlakem.
	 6			Dbejte na správnost montážní polohy.

de

Signalwörter & Symbole

-  **DANGER** GEFAHR Unmittelbar drohende Gefährdung: Schwere Personenschäden oder Tod
 -  **WARNING** VORSICHT Mögliche Gefahrensituation: Leichte oder mittelschwere Personenschäden oder Sachschäden als Folge
 -  **CAUTION** WARNUNG Mögliche Gefahrensituation: Tod oder schwere Personenschäden als Folge
-  Teile mit Kreis um die Positionsnummer sind im Reparatursatz enthalten.

-  Anweisung / Information für eine korrekte Reparatur
-  Der Reparatursatz kann für Geräte entsprechend Tabelle verwendet werden.
-  Element mit angegebenen Drehmoment bzw. Drehwinkel anziehen.

de







Allgemeine Reparaturhinweise

1. Reparaturarbeiten an Geräten eines Fahrzeug-Sicherheitssystems darf nur qualifiziertes Personal einer Fachwerkstatt durchführen.
2. Leisten Sie den Vorgaben und Anweisungen des Fahrzeugherstellers unbedingt Folge.
3. Halten Sie Unfallverhütungsvorschriften des Betriebes sowie nationale Vorschriften ein.
4. Verwenden Sie ausschließlich von WABCO oder vom Fahrzeughersteller freigegebene Ersatzteile.
5. Beginnen Sie die Reparatur erst dann, wenn Sie alle Informationen, die für die Reparatur notwendig sind, gelesen und verstanden haben. Zusätzlich benötigte Dokumente: Prüfanweisung, Ersatzteilblatt, Allgemeine Reparatur- und Prüfhinweise (815 020 109 3) zu finden auf www.wabco-auto.com mittels Eingabe der Produktnummer des Gerätes bzw. Druckschriftenummer in INFORM.
6. Prüfen Sie jedes reparierte Gerät – gemäß Prüfanweisung – an einer adäquaten Einrichtung auf Funktionstüchtigkeit und Dichtigkeit.
7. WABCO übernimmt keinerlei Gewährleistung für die Funktion oder Qualität eines reparierten Gerätes

Hinweis





- Setzen Sie das Fahrzeug auf Unterstellböcke.
- Machen Sie die Anlage stromlos und drucklos.



Montageanleitung

Bild	Symbol	Position	Wert	Hinweis
1	 1	2	7 ± 1 Nm	
	 2	8	9 + 2 / - 0 Nm	
1+2	 1, 5	3		Auf Markierung plaziert.
	 2			Prüfen Sie, ob alle pneumatischen und elektrischen Verbindungen hergestellt sind.
	 3	5		Achtung! Leitung kann unter Druck stehen.
3	 6			Einbaulage beachten.

en

Symbols & Signal Words

-  **DANGER** Imminent hazard situation: serious personal injury or death as a result
-  **WARNING** Possible hazard situation: minor or moderate personal injury or material loss as a result
-  **CAUTION** Possible hazard situation: serious personal injury or death as a result
-  Parts having item numbers with circles are included in the kit.

-  Instruction / Information for a correct repair
-  The kit can be used for devices according table.
-  Tighten element with specified torque or angle of rotation.

General Repair Hints







1. Only qualified personnel of a specialist workshop are authorized to perform repair work on a vehicle's security system.
2. Absolutely follow specifications and instructions of vehicle manufacturer.
3. Keep to company's relevant accident prevention regulations and national regulations.
4. Use only spare parts released by WABCO or vehicle manufacturer.
5. Always start repair work only when you have read and understood all information required for repair. Documents additionally needed: Test Instruction, Spare Parts List, General Repair and Test Hints (815 010 109 3) to be found on www.wabco-auto.com by entering product number of the device or the publication number in INFORM.
6. Check each repaired equipment for functional efficiency and tightness on an adequate facility according to the test instruction.
7. WABCO does not accept any liability or responsibility for the quality or functionality of a repaired device

Hint

- Place vehicle on safety stands.
- Make system electroless and pressureless.





en



Instructions for Installation

Picture	Symbol	Item	Value	Hint
1	 1	2	7 ± 1 Nm	
	 2	8	9 + 2 / - 0 Nm	
1+2	 1, 5	3		Located on marking.
	 2			Check that all the pneumatic and electrical connections are made.
	 3	5		Attention! Line can be under pressure.
3	 6			Observe installation position.

es

Símbolos & Palabras de aviso

-  **DANGER** PELIGRO Situación de peligro inminente: Pueden ocasionarse daños personales graves o incluso mortales
-  **WARNING** CUIDADO Posible situación de peligro: Pueden ocasionarse daños personales leves o moderados o pérdidas materiales
-  **CAUTION** ADVERTENCIA Posible situación de peligro: Pueden ocasionarse daños personales graves o incluso mortales
-  Los componentes incluidos en el kit son los números que aparecen con círculo.

-  Instrucciones/Información para una correcta reparación
-  El kit puede ser utilizado en los equipos que aparecen en la tabla.
-  Apretar el elemento con el par de apriete o ángulo de giro indicado.







Consejos generales de reparación

1. Sólo el personal cualificado de un taller especializado está autorizado para realizar las tareas de reparación en los sistemas de seguridad de los vehículos.
3. Siga las regulaciones y normas acerca de prevención de riesgos laborales de su empresa y de su país.
5. Comience la reparación sólo cuando haya leído y comprendido las instrucciones de reparación. Documentos adicionales necesarios: Instrucciones de comprobación, listas de despiece, consejos generales de comprobación y reparación (815 040 109 3), los cuales pueden encontrarse en www.wabco-auto.com, introduciendo la referencia del aparato o la referencia de la publicación en la aplicación INFORM.
7. WABCO no asume garantía alguna por el funcionamiento o calidad de un equipo reparado.
2. Atenerse exactamente a las indicaciones e instrucciones del fabricante del vehículo.
4. Utilice piezas de repuesto suministradas por WABCO o el fabricante del vehículo.
6. Compruebe la eficacia de funcionamiento y de ajuste de cada equipo reparado en unas instalaciones adecuadas según las instrucciones de comprobación.

Consejo





- Coloque el vehículo sobre soportes de seguridad.
- Disminuya la presión del sistema.



Instrucciones de montaje

Dibujo	Símbolo	Posición	Valor	Consejo
1	 1	2	7 ± 1 Nm	
	 2	8	9 + 2 / - 0 Nm	
1+2	 1, 5	3		Localizado en la marca.
	 2			Compruebe que se han realizado todas las conexiones neumáticas y eléctricas.
	 3	5		¡Atención! La línea puede estar presurizada.
3	 6			Prestar atención a la posición de instalación.

fr

Symboles & Significations

-  **DANGER** DANGER Situation de danger imminent : Danger de mort ou de dommage corporel sérieux.
-  **WARNING** ATTENTION Situation de danger probable : Risque de dommage corporel mineur ou modéré ou perte de matériel.
-  **CAUTION** AVERTISSEMENT Situation de danger de danger probable : Danger de mort ou de dommages corporel sérieux
-  Les composants avec repères entourés sont inclus dans le kit.

-  Instruction/Information pour une réparation correcte
-  Le kit peut être utilisé pour les appareils indiqués sur le Feuille.
-  Serrer l'élément avec le couple et la position angulaire indiqués.









Conseils généraux de réparation

1. Uniquement le personnel qualifié d'un atelier agréé WABCO est autorisé à effectuer la réparation sur les systèmes de sécurité d'un véhicule.
3. Veillez aux règlements de prévention des accidents indiqués par votre société et aux règlements nationaux.
5. Commencez toujours le travail de réparation seulement après avoir lu et compris toutes les informations indiquées pour la réparation. Documentation complémentaire nécessaire : Instruction d'essai, liste des pièces détachées, instructions de réparation et conseils d'essai (815 030 109 3) en tapant la référence du produit ou le numéro de la publication dans INFORM sur internet : www.wabco-auto.com
7. WABCO n'assume aucune garantie quant au fonctionnement ou à la qualité d'un appareil réparé.
2. Respecter toujours les prescriptions et instructions du constructeur du véhicule.
4. Employez seulement les pièces de rechange WABCO ou du constructeur du véhicule.
6. Examinez chaque appareil réparé pour s'assurer de l'efficacité fonctionnelle et de l'étanchéité selon l'instruction d'essai.

Conseil





- Placez le véhicule sur des stands de sécurité.
- Mettre le system hors électricité et hors pression.



Instructions d'installation

Image	Symbole	Position	Valeur	Conseil
	 1	2	7 ± 1 Nm	
	 2	8	9 + 2 / - 0 Nm	
	 1, 5	3		Situe sur marquage.
	 2			Vérifier que toutes les connexions électriques et pneumatiques sont faites.
	 3	5		Attention! La ligne peut être sous pression.
	 6			Faire attention à la position de montage.

hr

Simboli & Značenja

-  **DANGER** OPREZ Neposredna rizična situacija: moguće ozbiljno ozljeđivanje ili smrt
-  **WARNING** OPASNOST neposredna rizična situacija: moguće manje ozljeđivanje mterijalna šteta
-  **CAUTION** UPOZORENJE Neposredna rizična situacija: moguće ozbiljno ozljeđivanje ili smrt
-  Dijelovi uređaja čiji su brojevi zaokruženi nalaze se u kompletu..

-  Informacija o ispravnom popravku.
-  Set može biti korišten za uređaje prema tabeli.
-  Zategnite element primjenom navedenog zakretnog momenta ili zakretnog kuta.

hr







Opće upute o popravcima

1. Samo kvalificirane osobe istručnjaci smiju popravljati siguronosne sustave na vozilu.
3. Provodi tvrtkine siguronosne propise kao i nacionalne propise o sigurnosti
5. Popravak počni tek nakon što pročitaš i shvatiš upute o popravku. Potrebni dokumenti: Instrukcije o testiranju, Lista rezervnih dijelova, Opće natuknice o popravku i testiranju (815 010 109 3) mogu se naći na www.wabco-auto.com nakon upisa kataložskog broja proizvoda ili publikacije u INFORM-u.
7. WABCO ne preuzima odgovornost za rad i kvalitetu popravljenog uređaja.
2. U potpunosti slijedi specifikacije i upute proizvođača vozila.
4. Koristi rezervne dijelove proizvedene od WABCA ili proizvođača vozila..
6. Provjeri svaki popravljeni uređaj kako radi i da li je zategnuto sve kako treba prema odgovarajućim uputama o testiranju proizvoda.

Naznaka





- Postavi vozilo na siguronosno postolje.
- Oslobodi sustav od napona i pritiska.



Upute za ugradnju

Slika	Simbol	Pojedinost	Vrijednost	Naznaka
1	 1	2	7 ± 1 Nm	
	 2	8	9 + 2 / - 0 Nm	
1+2	 1, 5	3		Položaj na tržištu.
	 2			Provjeri da li su spojeni svi električni i zračni priključci.
	 3	5		Pažnja! Linija može biti pod pritiskom.
3	 6			Provjeri položaj ugradnje.

it

Simboli e Segnali

-  **DANGER** PERICOLO Imminente situazione di rischio: serie ferite personali fino anche alle morte
-  **WARNING** PRUDENZA Possibili situazioni di pericolo: possibili lievi ferite o perdita di materiale
-  **CAUTION** AVVERTENZA Possibili situazioni di pericolo: serie ferite personali fino anche alle morte
-  I componenti indicati con un numero cerchiato, sono inclusi nel kit.

-  Istruzioni/Informazioni per unacorretta riparazione
-  Il kit può essere usato per gli articoli secondo la tabella.
-  Serrare l'elemento con la coppia/angolo di rotazione indicati.

Suggerimenti per la riparazione







1. Soltanto il personale qualificato delle officine specializzate è autorizzato ad effettuare le riparazioni sui sistemi di sicurezza dei veicoli.
3. Attenersi alle norme nazionali e aziendali in merito alla prevenzione degli infortuni.
5. Effettuare la riparazione solamente dopo aver letto e capito tutte le informazioni richieste per la riparazione. Ulteriori informazioni necessarie: istruzioni di collaudo, catalogo dei ricambi, cenni generali sulla riparazione e test (815 050 109 3) possono essere trovati sul sito www.wabco-auto.com alla voce INFORM entrando per codice del dell'apparecchio o per numero della pubblicazione.
7. WABCO non si assume alcuna responsabilità per il funzionamento o la qualità di un apparecchio riparato.
2. E' assolutamente necessario seguire le istruzioni e le specifiche del costruttore del veicolo.
4. Usare solo ricambi originali WABCO o del costruttore del veicolo.
6. Controllare la funzionalità e l'efficienza di ogni apparecchiatura riparata secondo le istruzioni riportate nel manuale di collaudo.

it

Suggerimento





- Mettere in sicurezza il veicolo tale che non si muova.
- Fare in modo che il sistema sia privo da scariche elettriche e pressioni residue.

Istruzioni d'installazione

Figura	Simbolo	Particolare	Valore	Suggerimento
1	 1	2	7 ± 1 Nm	
	 2	8	9 + 2 / - 0 Nm	
1+2	 1, 5	3		Situato sulla marcatura.
	 2			Controllare che tutte le connessioni pneumatiche ed elettriche siano state effettuate.
	 3	5		Attenzione! La linea potrebbe essere sotto pressione.
3	 6			Osservare la posizione di montaggio.

pl

Hasła ostrzegawcze i symbole

-  **DANGER** NIEBEZPIECZEŃSTWO Bezpośrednie zagrożenie ciężkimi obrażeniami bądź śmiercią.
-  **WARNING** UWAGA! Niebezpieczeństwo grożące lekkimi bądź średnimi obrażeniami.
-  **CAUTION** OSTRZEŻENIE Niebezpieczeństwo grożące śmiercią bądź ciężkimi obrażeniami.
-  Części oznaczone kółkiem wokół numeru pozycji należą do zestawu naprawczego.

 Wskazówki / Informacje dotyczące poprawnej naprawy.

 Zestaw naprawczy może być używany do urządzeń według tabeli.

 Dokręcić element podanym momentem obrotowym.

Ogólne porady naprawcze







1. Prace naprawcze w obrębie urządzeń układu bezpieczeństwa pojazdu mogą być wykonane jedynie przez wykwalifikowany personel specjalistycznego warsztatu.
2. Należy koniecznie postępować według wytycznych i wskazówek producenta pojazdu.
3. Należy przestrzegać zakładowych i krajowych przepisów BHP.
4. Należy używać wyłącznie części zamiennych dopuszczonych przez firmę WABCO bądź przez producenta pojazdu.
5. Naprawę należy rozpocząć dopiero wówczas, gdy wszystkie potrzebne do niej informacje zostaną przeczytane i zrozumiane. Dokumenty potrzebne dodatkowo: instrukcja kontrolna, tabela części zamiennych, ogólne wskazówki dotyczące naprawy i kontroli (815 020 109 3) znajdują Państwo na stronie internetowej www.wabco-auto.com, podając numer urządzenia bądź numer publikacji w bazie INFORM.
6. Na odpowiednim urządzeniu należy sprawdzić każde naprawiane urządzenie - zgodnie z instrukcją kontrolną - pod kątem sprawności działania i szczelności.
7. WABCO nie udziela żadnej gwarancji na działanie lub jakość naprawionego urządzenia.

Wskazówka

- Umieść pojazd na bezpiecznym miejscu.
- Odłącz napięcie i spuść powietrze z systemu.





pl



Instrukcja montażu

Obraz	Symbol	Pozycja	Wartość	Wskazówka
1	 1	2	7 ± 1 Nm	
	 2	8	9 + 2 / - 0 Nm	
1+2	 1, 5	3		Umieścić w oznaczonym miejscu.
	 2			Sprawdź czy wszystkie połączenia elektryczne i pneumatyczne są podłączone.
	 3	5		Uwaga! Przewód może być pod ciśnieniem.
3	 6			Zwrócić uwagę na położenie montażowe.

ru

Знаки & символы

-  **DANGER** ОПАСНО Прямая угроза аварийной ситуации: влечет за собой смерть или тяжелые повреждения
-  **WARNING** ОСТОРОЖНО Опасная ситуация: последствием являются легкие повреждения или повреждения средней тяжести, а также материальный ущерб
-  **CAUTION** ПРЕДУПРЕЖДЕНИЕ Опасная ситуация: влечет за собой смерть или тяжелые повреждения
-  Номера частей, обведенные кружком, Вы найдете в ремкомплекте.

-  Указание/информация для проведения надлежащего ремонта
-  Ремкомплект может быть использован для приборов соответственно таблице.
-  Затянуть элемент с заданным моментом затяжки или на заданный угол поворота.

Общие указания по ремонту







1. Провождение ремонта приборов данной системы должно производиться только квалифицированным персоналом в специализированной мастерской.
3. Соблюдайте предписания предприятия по технике безопасности, а также национальные нормы.
5. Проводите ремонт только после того, как вы прочитали и поняли все информации, необходимые для данного процесса. Дополнительные документы: инструкция по тестированию, список запасных частей, общие инструкции по ремонту и проведению испытаний (815 080 109 3) Вы найдете на www.wabco-auto.com. Для этого необходимо задать номер нужного прибора или номер брошюры в INFORM.
7. Компания WABCO не принимает на себя какую-либо ответственность за работу или качество отремонтированных устройств.
2. Следуйте предписаниям и инструкциям изготовителя транспортного средства.
4. Используйте только запчасти, допущенные к использованию компанией Wabco или производителем транспортного средства.
6. Проконтролируйте каждый отремонтированный прибор- согласно инструкции по тестированию- на работоспособность и герметичность с помощью соответствующего оборудования.

Указание

- Разместите автомобиль на безопасном стенде.
- Обесточьте электросистему и спустите давление.





ru



Руководство по установке

Изображение	Символ	Позиция	Значение	Указание
1	 1	2	7 ± 1 Nm	
	 2	8	9 + 2 / - 0 Nm	
1+2	 1, 5	3		Размещено на маркировке.
	 2			Проверьте правильность соединения всех пневматических и электрических соединений.
	 3	5		Внимание! Пневмомагистраль может быть под давлением.
3	 6			Обратите внимание на местоположение при монтаже.

tr

Semboller&belirti sözleri

-  **DANGER** TEHLİKE Tehlikeli durum: ciddi personel yaralanması veya ölüm riski.
-  **WARNING** DİKKAT Tehlike riski: hafif personel yaralanması veya maddi zarar.
-  **CAUTION** UYARI Ciddi personel yaralanması veya ölüm riski.
-  Yuvarlak içinde numarası belirtilen parça numaraları kit içerisinde bulunur.

-  Talimat/ Doğru tamir için bilgi
-  Tabloda belirtilen parçalar için kit kullanılabilir.
-  Elemanı belirtilen sıkma torku ya da dönme açısı ile sıkın.







Genel tamir bilgisi

- Araçların güvenlik sistemlerinde tamir işlemlerini yalnızca eğitim almış konusunda uzman personeller gerçekleştirebilir.
- Şirket emniyet kuralları ve ulusal regülasyonlarına uyunuz.
- Tamire, tamir işlemi için gerekli olan tüm bilgileri okuyup anladıktan sonra başlayınız. Ayrıca gerekli olan dokümanlar: Test talimatı, yedek parça sayfası, genel tamir ve test bilgileri (815 140 109 3). Tümünü linki altında, online ürün kataloğu INFORM'da cihaza ait ürün numarasını veya baskı numarasını girerek bulabilirsiniz.
- WABCO tamir edilmiş bir cihazın işlevselliği veya kalitesi için hiçbir sorumluluk üstlenmemektedir.
- Araç üretici firma özellikler ve talimatlarına kesinlikle uyunuz.
- Sadece WABCO veya üretici firma tarafından yayınlanan yedek parçaları kullanın.
- Tamir edilmiş her cihazı - test talimatına uygun şekilde - uygun bir donanımla işlevsellik ve sızdırmazlık konusunda kontrol edin.

İp ucu





- Artacı güvenli bir yere çıkarın.
- Sistemi akımsız ve basınçsız duruma getirin.



Montaj talimatı

Resim	Sembol	Parça	Değer	İp ucu
1	 1	2	7 ± 1 Nm	
	 2	8	9 + 2 / - 0 Nm	
1+2	 1, 5	3		İşaretili yerde bulunur.
	 2			Tüm pnomatik ve elektriksel bağlantıların gerçekleştirildiğini kontrol edin.
	 3	5		Dikkat! Hatta basınç olabilir.
3	 6			Montaj konumuna dikkat.

pt

Símbolos e Significados

-  **DANGER** Perigo! Risco de acidente iminente: lesão corporal grave e/ou risco de morte.
-  **WARNING** Cuidado! Possível situação de acidente: ferimentos leves/moderados e/ou danos materiais.
-  **CAUTION** Atenção! Possível situação de acidente: lesão corporal grave e/ou risco de morte.
-  Componentes que estão marcados com um círculo compõem o jogo de reparo.

-  Instrução/Informação para uma correta reparação.
-  O jogo de reparo pode ser utilizado nos produtos relacionados na tabela.
-  Apertar o elemento com o binário ou o ângulo de rotação indicado.







Dicas Gerais para Reparação

1. Por motivo de segurança, somente pessoas qualificadas devem efetuar reparação nos sistemas de freio do veículo.
3. Mantenha e siga as orientações de prevenção de acidentes vigentes e/ou impostas pelos órgãos competentes.
5. Somente inicie o trabalho de reparação após ler e entender todas as informações necessárias para realizar uma reparação. Documentos adicionais necessários: instrução de teste, lista de peças sobressalentes, dicas gerais de testes e reparação (815 130 109 3) podem ser encontrados no site www.wabco-auto.com ao inserir o número do produto.
7. A WABCO não assume qualquer responsabilidade pela função ou qualidade de um equipamento reparado.
2. Siga sempre as recomendações/especificações do fabricante do veículo.
4. Use somente peças de reposição aprovadas pela WABCO ou pelo fabricante do veículo.
6. Verificar cada produto reparado conforme instruções de teste, utilizando os equipamentos necessários e local adequado.

Sugestão





- Posicionar o veículo nos cavaletes com segurança.
- Realizar a manutenção do veículo com o sistema elétrico desligado e o sistema pneumático despressurizado.



Instruções para instalação

Figura	Símbolo	Item	Valor	Sugestão
1	 1	2	7 ± 1 Nm	
	 2	8	9 + 2 / - 0 Nm	
1+2	 1, 5	3		Localizado para marcação.
	 2			Verifique se estão estabelecidas todas as conexões pneumáticas e elétricas.
	 3	5		Atenção! A linha de Ar pode estar pressurizada.
3	 6			Observar a posição de montagem

ro

Simboluri și cuvinte pentru avertizare

-  **DANGER** Situație de pericol iminentă: poate rezulta vătămare corporală gravă sau deces.
-  **WARNING** Posibilă situație de pericol: pot rezulta vătămări corporale minore sau medii sau pagube materiale
-  **CAUTION** Posibilă situație de pericol: poate rezulta vătămare corporală gravă sau deces
-  Pieșele cu numărul de articol încercuit sunt incluse în kit.

-  Instrucțiuni / Informare pentru o reparare corectă
-  Kitul poate fi folosit pentru dispozitive, conform tabelului.
-  Strângeți elementul cu cuplul, respectiv unghiul de rotire indicat.







Instrucțiuni generale referitoare la reparație

1. Numai personalul calificat al unui atelier de service specializat este autorizat să efectueze lucrări de reparații pe sistemul de siguranță al vehiculului.
2. Respectați obligatoriu instrucțiunile date de producătorul vehiculului.
3. Respectați prevederile firmei și cele naționale pentru prevenirea accidentelor.
4. Utilizați exclusiv piese de schimb autorizate de WABCO sau de producătorul autovehiculului.
5. Întotdeauna începeți lucrările de reparații numai după ce ați citit și înțeles toate informațiile necesare pentru reparație. Documente suplimentare necesare: Instrucțiuni de testare, Lista pieselor de schimb, Instrucțiuni generale pentru reparare și testare (815 110 109 3) pot fi găsite pe www.wabco-auto.com introducând codul dispozitivului în INFORM.
6. Verifică eficiența funcțională și etanșeitatea fiecărui echipament reparat pe o instalație adecvată în conformitate cu instrucțiunile de testare.
7. WABCO nu garantează sau nu răspunde pentru funcționarea și calitatea unui dispozitiv reparat.

Instrucțiune

- Plasati vehiculul pe un loc sigur.
- Opriti alimentarea sistemului cu tensiune și goliți presiunea.

Instrucțiuni pentru instalare

Imagine	Simbol	Articol	Valoare	Instrucțiune
1	 1	2	7 ± 1 Nm	
	 2	8	9 + 2 / - 0 Nm	
1+2	 1, 5	3		Situat pe marcaj.
	 2			Verificați dacă toate conexiunile electrice și pneumatice sunt făcute.
	 3	5		Atenție! Poate exista presiune pe tub.
3	 6			Observați poziția de instalare.