

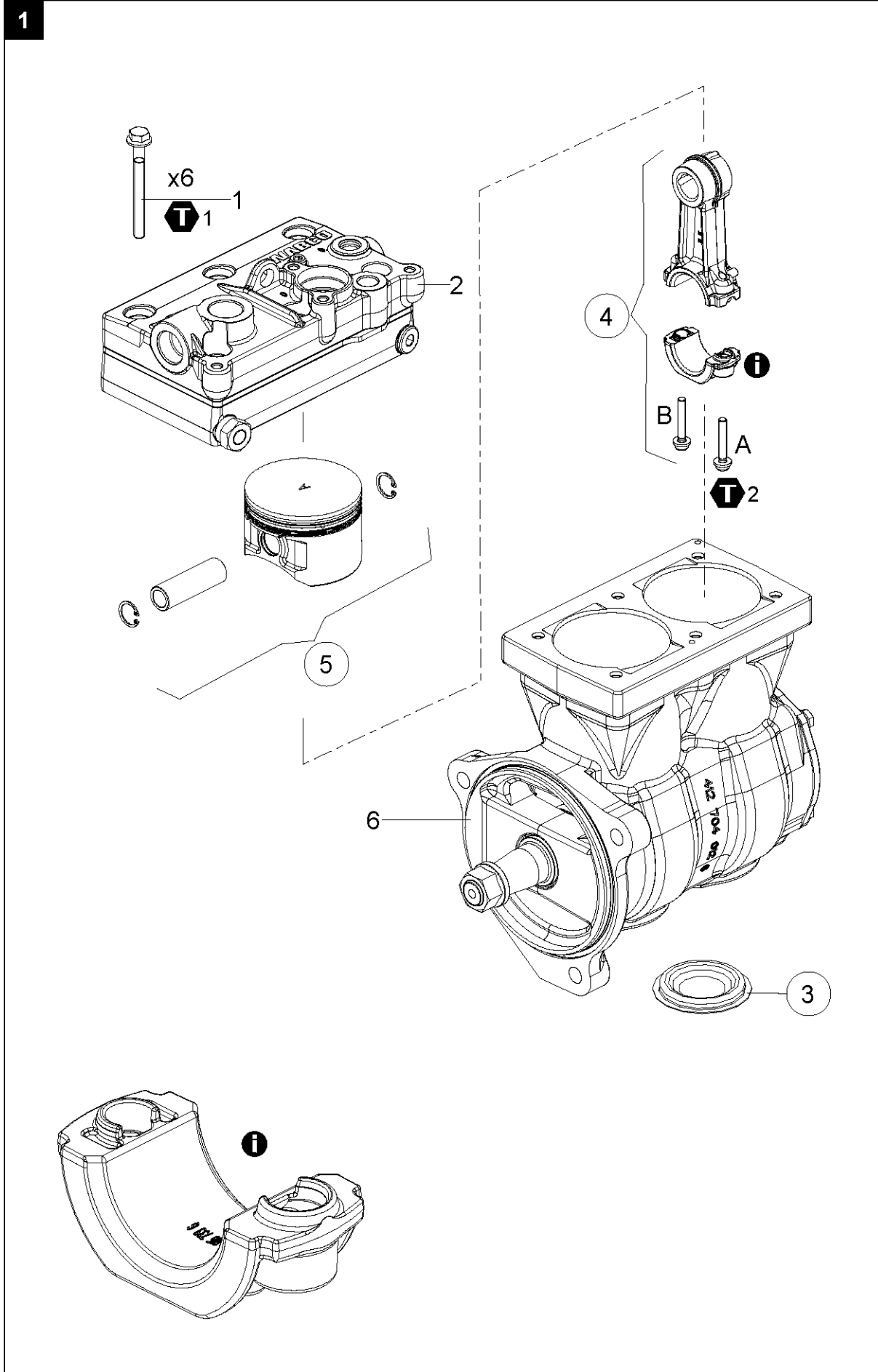

412 352 029 0  
412 352 030 0  
412 704 019 0  
412 704 024 0  
412 704 025 0

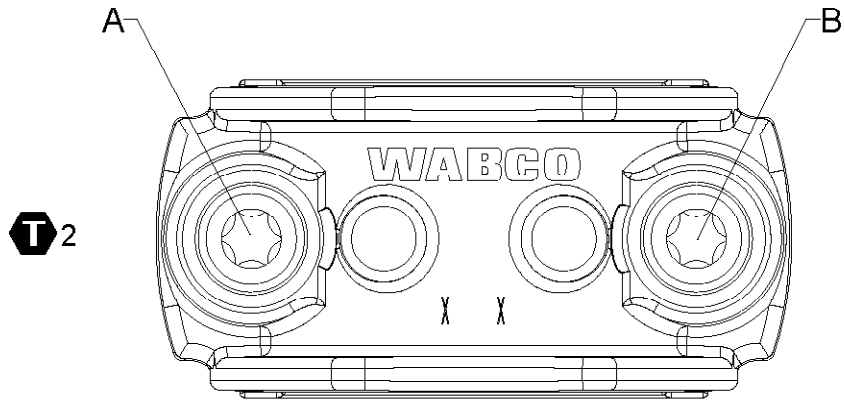

2





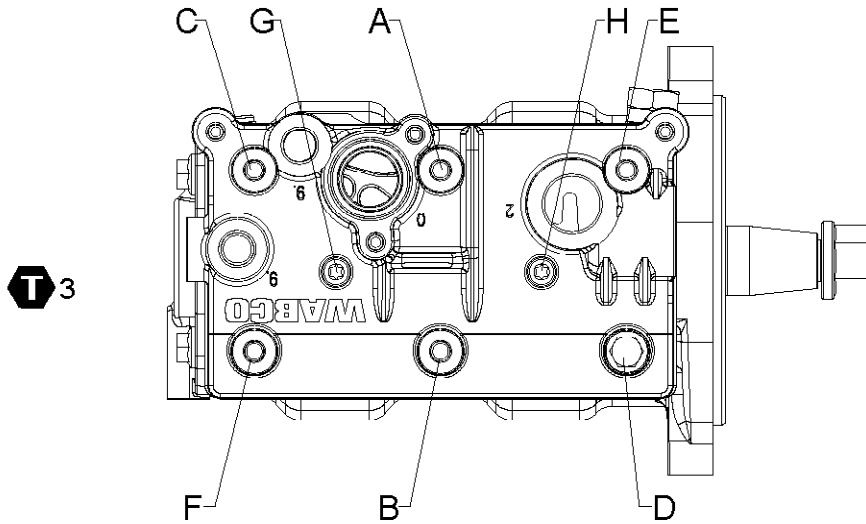

3

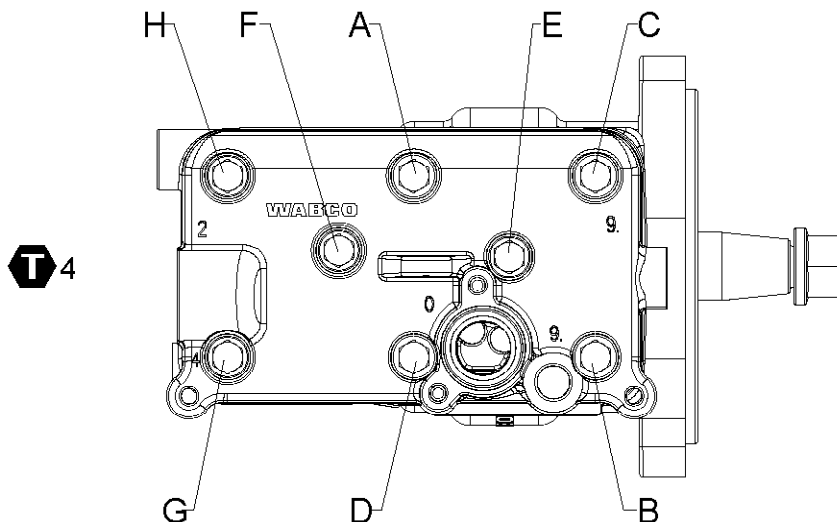



4



## Signální slova a symboly











-  **DANGER** NEBEZPEČÍ Bezprostředně hrozící nebezpečí: těžká újma na zdraví nebo smrt
-  **WARNING** POZOR Možná nebezpečná situace: jako následek lehká nebo středně těžká újma na zdraví nebo poškození majetku
-  **CAUTION** VÝSTRAHA Možná nebezpečná situace: jako následek těžká újma na zdraví nebo smrt
-  Díly, které mají číslo pozice v kroužku, jsou obsaženy v opravárenské sadě.
-  Úhel pootočení pro dotažení.

-  Instrukce / informace ke správnému provedení opravy
-  Opravárenskou sadu je možné použít pro přístroje uvedené v tabulce.
-  Prvek utáhněte uvedeným točivým momentem příp. pomocí kontroly úhlu natočení.
- NOTE** Instrukce / informace ke správnému provedení opravy

## Všeobecné pokyny k opravám





1. Opravárenské práce na přístrojích systému, který má vliv na bezpečnost vozidla, smí provádět pouze kvalifikovaný personál odborné servisní dílny.
3. Dodržujte předpisy BOZP podniku a národní předpisy.
5. S opravou začněte teprve tehdy, až všechny informace nutné pro opravu přečtete a porozumíte jim. Další potřebné dokumenty: zkušební postup, list náhradních dílů, všeobecné pokyny pro opravu a kontrolu (815 150 109 3) naleznete na internetových stránkách: [www.wabco-auto.com](http://www.wabco-auto.com), když v databázi INFORM zadáte produktové číslo přístroje nebo číslo dokumentu.
7. WABCO nepřebírá žádnou záruku za funkci nebo kvalitu opraveného přístroje.
2. Postupujte bezpodmínečně podle pokynů a instrukcí výrobce vozidla.
4. Používejte výhradně náhradní díly od firmy WABCO nebo díly schválené výrobcem vozidla.
6. Na adekvátním zařízení přezkoušejte – podle zkušebního postupu – každý opravený přístroj na funkčnost a těsnost.

## Postup montáže

Obrázek	Symbol	Pracovní operace	Pořadí:	Utahovací moment:	Úhel pootočení pro dotažení:	Poznámky
<b>1+3</b>	 1, 3					pro přístroje 412 704 019 0, 412 704 024 0, 412 704 025 0
		1	A, B, C, D, E, F	M = 20 ± 2 Nm		Před dalším pracovním krokem se ujistěte, že jsou všechny šrouby utaženy správným momentem.
		2.1	A, B, C, D, E, F		90° + 10° / -5°	
		2.2	A, B, C, D, E, F		90° + 10° / -5°	
		3	G, H			Povolte šroub. 180°
		4	G, H	M = 7 ± 2 Nm		
		5	G, H		180° + 10° / -5°	
<b>1+2</b>	 2	1	A, B	M = 6 ± 0.6 Nm		
		2	A, B		70° + 15° / -5°	
<b>4</b>	 4					pro přístroje 412 352 029 0, 412 352 030 0
		1	A, B, C, D	M = 25 ± 2 Nm		Před dalším pracovním krokem se ujistěte, že jsou všechny šrouby utaženy správným momentem.
		2	A, B, C, D		90° + 10° / -5°	
		3	E, F, G, H			Povolte šroub. 180°
		4	E, F, G, H	M = 10 ± 2 Nm		Před dalším pracovním krokem se ujistěte, že jsou všechny šrouby utaženy správným momentem.
		5	E, F, G, H		120° + 10° / -5°	
<b>1</b>						Dbejte na správnost montážní polohy.

de

## Signalwörter & Symbole

-  **DANGER** GEFAHR Unmittelbar drohende Gefährdung: Schwere Personenschäden oder Tod
-  **WARNING** VORSICHT Mögliche Gefahrensituation: Leichte oder mittelschwere Personenschäden oder Sachschäden als Folge
-  **CAUTION** WARNUNG Mögliche Gefahrensituation: Tod oder schwere Personenschäden als Folge
-  Teile mit Kreis um die Positionsnummer sind im Reparatursatz enthalten.
-  Weiterdrehwinkel.

 Anweisung / Information für eine korrekte Reparatur

 Der Reparatursatz kann für Geräte entsprechend Tabelle verwendet werden.











 Element mit angegebenen Drehmoment bzw. Drehwinkel anziehen.

**NOTE** Anweisung / Information für eine korrekte Reparatur

## Allgemeine Reparaturhinweise





1. Reparaturarbeiten an Geräten eines Fahrzeug-Sicherheitssystems darf nur qualifiziertes Personal einer Fachwerkstatt durchführen.
3. Halten Sie Unfallverhütungsvorschriften des Betriebes sowie nationale Vorschriften ein.
5. Beginnen Sie die Reparatur erst dann, wenn Sie alle Informationen, die für die Reparatur notwendig sind, gelesen und verstanden haben. Zusätzlich benötigte Dokumente: Prüfanweisung, Ersatzteilblatt, Allgemeine Reparatur- und Prüfhinweise (815 020 109 3) zu finden auf [www.wabco-auto.com](http://www.wabco-auto.com) mittels Eingabe der Produktnummer des Gerätes bzw. Druckschriftennummer in INFORM.
7. WABCO übernimmt keinerlei Gewährleistung für die Funktion oder Qualität eines reparierten Gerätes
2. Leisten Sie den Vorgaben und Anweisungen des Fahrzeugherstellers unbedingt Folge.
4. Verwenden Sie ausschließlich von WABCO oder vom Fahrzeughersteller freigegebene Ersatzteile.
6. Prüfen Sie jedes reparierte Gerät – gemäß Prüfanweisung – an einer adäquaten Einrichtung auf Funktionstüchtigkeit und Dichtigkeit.



## Montage Reihenfolge

Bild	Symbol	Arbeitsschritt	Reihenfolge:	Anzugsdrehmoment:	Weiterdrehwinkel:	Bemerkungen
<b>1+3</b>	 1, 3					für Geräte 412 704 019 0, 412 704 024 0, 412 704 025 0
		1	A, B, C, D, E, F	M = 20 ± 2 Nm		Stellen Sie vor dem nächsten Arbeitsschritt sicher, dass alle Schrauben das richtige Anzugsmoment haben.
		2.1	A, B, C, D, E, F		90° +10° /-5°	
		2.2	A, B, C, D, E, F		90° +10° /-5°	
		3	G, H			Schraube lösen. 180°
		4	G, H	M = 7 ± 2 Nm		
		5	G, H		180° + 10° /-5°	
<b>1+2</b>	 2	1	A, B	M = 6 ± 0.6 Nm		
		2	A, B		70° + 15° /-5°	
<b>4</b>	 4					für Geräte 412 352 029 0, 412 352 030 0
		1	A, B, C, D	M = 25 ± 2 Nm		Stellen Sie vor dem nächsten Arbeitsschritt sicher, dass alle Schrauben das richtige Anzugsmoment haben.
		2	A, B, C, D		90° + 10° /-5°	
		3	E, F, G, H			Schraube lösen. 180°
		4	E, F, G, H	M = 10 ± 2 Nm		Stellen Sie vor dem nächsten Arbeitsschritt sicher, dass alle Schrauben das richtige Anzugsmoment haben.
		5	E, F, G, H		120° + 10° /-5°	
<b>1</b>						Einbaulage beachten.

en

## Symbols & Signal Words











-  **DANGER** Imminent hazard situation: serious personal injury or death as a result
-  **WARNING** Possible hazard situation: minor or moderate personal injury or material loss as a result
-  **CAUTION** Possible hazard situation: serious personal injury or death as a result
-  Parts having item numbers with circles are included in the kit.
-  Rotation angle.

-  Instruction / Information for a correct repair
-  The kit can be used for devices according table.
-  Tighten element with specified torque or angle of rotation.
- NOTE** Instruction / Information for a correct repair

## General Repair Hints





1. Only qualified personnel of a specialist workshop are authorized to perform repair work on a vehicle's security system.
2. Absolutely follow specifications and instructions of vehicle manufacturer.
3. Keep to company's relevant accident prevention regulations and national regulations.
4. Use only spare parts released by WABCO or vehicle manufacturer.
5. Always start repair work only when you have read and understood all information required for repair. Documents additionally needed: Test Instruction, Spare Parts List, General Repair and Test Hints (815 010 109 3) to be found on [www.wabco-auto.com](http://www.wabco-auto.com) by entering product number of the device or the publication number in INFORM.
6. Check each repaired equipment for functional efficiency and tightness on an adequate facility according to the test instruction.
7. WABCO does not accept any liability or responsibility for the quality or functionality of a repaired device

## Sequence of assembly

Picture	Symbol	Procedure	Sequence:	Torque:	Rotation angle:	Comments
<b>1+3</b>	 1, 3					for devices 412 704 019 0, 412 704 024 0, 412 704 025 0
		1	A, B, C, D, E, F	M = 20 ± 2 Nm		Ensure accurate torque at all screws before next step.
		2.1	A, B, C, D, E, F		90° +10° /-5°	
		2.2	A, B, C, D, E, F		90° +10° /-5°	
		3	G, H			Unbolt screw.180°
		4	G, H	M = 7 ± 2 Nm		
		5	G, H		180° + 10° /-5°	
<b>1+2</b>	 2	1	A, B	M = 6 ± 0.6 Nm		
		2	A, B		70° + 15° /-5°	
<b>4</b>	 4					for devices 412 352 029 0, 412 352 030 0
		1	A, B, C, D	M = 25 ± 2 Nm		Ensure accurate torque at all screws before next step.
		2	A, B, C, D		90° + 10° /-5°	
		3	E, F, G, H			Unbolt screw. 180°
		4	E, F, G, H	M = 10 ± 2 Nm		Ensure accurate torque at all screws before next step.
		5	E, F, G, H		120° + 10° /-5°	
<b>1</b>						Observe installation position.

es

## Símbolos & Palabras de aviso

-  **DANGER** PELIGRO Situación de peligro inminente: Pueden ocasionarse daños personales graves o incluso mortales
-  **WARNING** CUIDADO Posible situación de peligro: Pueden ocasionarse daños personales leves o moderados o pérdidas materiales
-  **CAUTION** ADVERTENCIA Posible situación de peligro: Pueden ocasionarse daños personales graves o incluso mortales
-  Los componentes incluidos en el kit son los números que aparecen con círculo.
-  Ángulo de rotación.

 Instrucciones/Información para una correcta reparación

 El kit puede ser utilizado en los equipos que aparecen en la tabla.











 Apretar el elemento con el par de apriete o ángulo de giro indicado.

**NOTE** Instrucciones/Información para una correcta reparación

## Consejos generales de reparación





1. Sólo el personal cualificado de un taller especializado está autorizado para realizar las tareas de reparación en los sistemas de seguridad de los vehículos.
3. Siga las regulaciones y normas acerca de prevención de riesgos laborales de su empresa y de su país.
5. Comience la reparación sólo cuando haya leído y comprendido las instrucciones de reparación. Documentos adicionales necesarios: Instrucciones de comprobación, listas de despiece, consejos generales de comprobación y reparación (815 040 109 3), los cuales pueden encontrarse en [www.wabco-auto.com](http://www.wabco-auto.com), introduciendo la referencia del aparato o la referencia de la publicación en la aplicación INFORM.
7. WABCO no asume garantía alguna por el funcionamiento o calidad de un equipo reparado.
2. Atenerse exactamente a las indicaciones e instrucciones del fabricante del vehículo.
4. Utilice piezas de repuesto suministradas por WABCO o el fabricante del vehículo.
6. Compruebe la eficacia de funcionamiento y de ajuste de cada equipo reparado en unas instalaciones adecuadas según las instrucciones de comprobación.

## Montaje sucesión

Dibujo	Símbolo	Procedimiento	Secuencia de serraggio:	Par de apriete:	Ángulo de rotación:	Observaciones
<b>1+3</b>	 1, 3					para aparatos 412 704 019 0, 412 704 024 0, 412 704 025 0
		1	A, B, C, D, E, F	M = 20 ± 2 Nm		Asegurese de aplicar el par de apriete adecuado en todos los tornillos antes de pasar al siguiente punto.
		2.1	A, B, C, D, E, F		90° +10° /-5°	
		2.2	A, B, C, D, E, F		90° +10° /-5°	
		3	G, H			Destornillar. 180°
		4	G, H	M = 7 ± 2 Nm		
		5	G, H		180° + 10° /-5°	
<b>1+2</b>	 2	1	A, B	M = 6 ± 0.6 Nm		
		2	A, B		70° + 15° /-5°	
<b>4</b>	 4					para aparatos 412 352 029 0, 412 352 030 0
		1	A, B, C, D	M = 25 ± 2 Nm		Asegurese de aplicar el par de apriete adecuado en todos los tornillos antes de pasar al siguiente punto.
		2	A, B, C, D		90° + 10° /-5°	
		3	E, F, G, H			Destornillar. 180°
		4	E, F, G, H	M = 10 ± 2 Nm		Asegurese de aplicar el par de apriete adecuado en todos los tornillos antes de pasar al siguiente punto.
		5	E, F, G, H		120° + 10° /-5°	
<b>1</b>						Prestar atención a la posición de instalación.

fr

## Symboles & Significations

-  **DANGER** DANGER Situation de danger imminent : Danger de mort ou de dommage corporel sérieux.
-  **WARNING** ATTENTION Situation de danger probable : Risque de dommage corporel mineur ou modéré ou perte de matériel.
-  **CAUTION** AVERTISSEMENT Situation de danger de danger probable : Danger de mort ou de dommages corporel sérieux
-  Les composants avec repères entourés sont inclus dans le kit.
-  Angle de rotation.

 Instruction/Information pour une réparation correcte

 Le kit peut être utilisé pour les appareils indiqués sur le Feuille.











 Serrer l'élément avec le couple et la position angulaire indiqués.

**NOTE** Instruction/Information pour une réparation correcte

## Conseils généraux de réparation





1. Uniquement le personnel qualifié d'un atelier agréé WABCO est autorisé à effectuer la réparation sur les systèmes de sécurité d'un véhicule.
2. Respecter toujours les prescriptions et instructions du constructeur du véhicule.
3. Veillez aux règlements de prévention des accidents indiqués par votre société et aux règlements nationaux.
4. Employez seulement les pièces de rechange WABCO ou du constructeur du véhicule.
5. Commencez toujours le travail de réparation seulement après avoir lu et compris toutes les informations indiquées pour la réparation. Documentation complémentaire nécessaire : Instruction d'essai, liste des pièces détachées, instructions de réparation et conseils d'essai (815 030 109 3) en tapant la référence du produit ou le numéro de la publication dans INFORM sur internet : [www.wabco-auto.com](http://www.wabco-auto.com)
6. Examinez chaque appareil réparé pour s'assurer de l'efficacité fonctionnelle et de l'étanchéité selon l'instruction d'essai.
7. WABCO n'assume aucune garantie quant au fonctionnement ou à la qualité d'un appareil réparé.



## Les montages ordre

Image	Symbole	Procédure	Sequence:	Couple de serrage:	Angle de rotation:	Remarques
<b>1+3</b>	 1, 3					pour appareils 412 704 019 0, 412 704 024 0, 412 704 025 0
		1	A, B, C, D, E, F	M = 20 ± 2 Nm		Assurez-vous d'un couple correct à toutes les vis avant l'étape suivante
		2.1	A, B, C, D, E, F		90° +10° /-5°	
		2.2	A, B, C, D, E, F		90° +10° /-5°	
		3	G, H			Dévisser. 180°
		4	G, H	M = 7 ± 2 Nm		
		5	G, H		180° + 10° /-5°	
<b>1+2</b>	 2	1	A, B	M = 6 ± 0.6 Nm		
		2	A, B		70° + 15° /-5°	
<b>4</b>	 4					pour appareils 412 352 029 0, 412 352 030 0
		1	A, B, C, D	M = 25 ± 2 Nm		Assurez-vous d'un couple correct à toutes les vis avant l'étape suivante
		2	A, B, C, D		90° + 10° /-5°	
		3	E, F, G, H			Dévisser. 180°
		4	E, F, G, H	M = 10 ± 2 Nm		Assurez-vous d'un couple correct à toutes les vis avant l'étape suivante
		5	E, F, G, H		120° + 10° /-5°	
<b>1</b>						Faire attention à la position de montage.

hr

## Simboli & Značenja











-  **DANGER** OPREZ Neposredna rizična situacija: moguće ozbiljno ozljeđivanje ili smrt
-  **WARNING** OPASNOST neposredna rizična situacija: moguće manje ozljeđivanje materijalna šteta
-  **CAUTION** UPOZORENJE Neposredna rizična situacija: moguće ozbiljno ozljeđivanje ili smrt
-  Dijelovi uređaja čiji su brojevi zaokruženi nalaze se u kompletu..
-  Kut zakretanja.

-  Informacija o ispravnom popravku.
-  Set može biti korišten za uređaje prema tabeli.
-  Zategnite element primjenom navedenog zakretnog momenta ili zakretnog kuta.
- NOTE** Informacija o ispravnom popravku.

## Opće upute o popravcima





1. Samo kvalificirane osobe istručnjaci smiju popravljati sigurnosne sustave na vozilu.
3. Provodi tvrtkine sigurnosne propise kao i nacionalne propise o sigurnosti
5. Popravak počni tek nakon što pročitaš i shvatiš upute o popravku. Potrebni dokumenti: Instrukcije o testiranju, Lista rezervnih dijelova, Opće natuknice o popravku i testiranju (815 010 109 3) mogu se naći na [www.wabco-auto.com](http://www.wabco-auto.com) nakon upisa kataloškog broja proizvoda ili publikacije u INFORM-u.
7. WABCO ne preuzima odgovornost za rad i kvalitetu popravljenog uređaja.
2. U potpunosti slijedi specifikacije i upute proizvođača vozila.
4. Koristi rezervne dijelove proizvedene od WABCA ili proizvođača vozila..
6. Provjeri svaki popravljeni uređaj kako radi i da li je zategnuto sve kako treba prema odgovarajućim uputama o testiranju proizvoda.

## Redoslijed ugradnje

Slika	Simbol	Postupak	Redoslijed:	Zakretni moment:	Kut zakretanja:	Komentar
<b>1+3</b>	 1, 3					za uređaj 412 704 019 0, 412 704 024 0, 412 704 025 0
		1	A, B, C, D, E, F	M = 20 ± 2 Nm		Provjeri da su vijci stegnuti ispravno odgovarajućom silom zatezanja prije slijedećeg koraka
		2.1	A, B, C, D, E, F		90° + 10° / -5°	
		2.2	A, B, C, D, E, F		90° + 10° / -5°	
		3	G, H			Otpusti vijak 180°
		4	G, H	M = 7 ± 2 Nm		
		5	G, H		180° + 10° / -5°	
<b>1+2</b>	 2	1	A, B	M = 6 ± 0.6 Nm		
		2	A, B		70° + 15° / -5°	
<b>4</b>	 4					za uređaj 412 352 029 0, 412 352 030 0
		1	A, B, C, D	M = 25 ± 2 Nm		Provjeri da su vijci stegnuti ispravno odgovarajućom silom zatezanja prije slijedećeg koraka
		2	A, B, C, D		90° + 10° / -5°	
		3	E, F, G, H			Otpusti vijak 180°
		4	E, F, G, H	M = 10 ± 2 Nm		Provjeri da su vijci stegnuti ispravno odgovarajućom silom zatezanja prije slijedećeg koraka
		5	E, F, G, H		120° + 10° / -5°	
<b>1</b>						Provjeri položaj ugradnje.



## Simboli e Segnali

-  **DANGER** PERICOLO Imminente situazione di rischio: serie ferite personali fino anche alle morte
-  **WARNING** PRUDENZA Possibili situazioni di pericolo: possibili lievi ferite o perdita di materiale
-  **CAUTION** AVVERTENZA Possibili situazioni di pericolo: serie ferite personali fino anche alle morte
-  I componenti indicati con un numero cerchiato, sono inclusi nel kit.
-  Angolo di rotazione.

 Istruzioni/Informazioni per unacorretta riparazione

 Il kit può essere usato per gli articoli secondo la tabella.

 Serrare l'elemento con la coppia/angolo di rotazione indicati.

**NOTE** Istruzioni/Informazioni per unacorretta riparazione

## Suggerimenti per la riparazione





1. Soltanto il personale qualificato delle officine specializzate è autorizzato ad effettuare le riparazioni sui sistemi di sicurezza dei veicoli.
3. Attenersi alle norme nazionali e aziendali in merito alla prevenzione degli infortuni.
5. Effettuare la riparazione solamente dopo aver letto e capito tutte le informazioni richieste per la riparazione. Ulteriori informazioni necessarie: istruzioni di collaudo, catalogo dei ricambi, cenni generali sulla riparazione e test (815 050 109 3) possono essere trovati sul sito [www.wabco-auto.com](http://www.wabco-auto.com) alla voce INFORM entrando per codice dell'apparecchio o per numero della pubblicazione.
7. WABCO non si assume alcuna responsabilità per il funzionamento o la qualità di un apparecchio riparato.
2. E' assolutamente necessario seguire le istruzioni e le specifiche del costruttore del veicolo.
4. Usare solo ricambi originali WABCO o del costruttore del veicolo.
6. Controllare la funzionalità e l'efficienza di ogni apparecchiatura riparata secondo le istruzioni riportate nel manuale di collaudo.



## Sequenza di montaggio

Figura	Simbolo	Fase di lavoro	Sequenza:	Coppia di serraggio:	Angolo di rotazione:	Note
<b>1+3</b>	 1, 3					per apparecchi 412 704 019 0, 412 704 024 0, 412 704 025 0
		1	A, B, C, D, E, F	M = 20 ± 2 Nm		Assicurarsi prima dell'operazione di lavoro successiva che tutte le viti abbiano la corretta coppia di serraggio.
		2.1	A, B, C, D, E, F		90° +10° /-5°	
		2.2	A, B, C, D, E, F		90° +10° /-5°	
		3	G, H			Svitare la vite. 180°
		4	G, H	M = 7 ± 2 Nm		
		5	G, H		180° + 10° /-5°	
<b>1+2</b>	 2	1	A, B	M = 6 ± 0.6 Nm		
		2	A, B		70° + 15° /-5°	
<b>4</b>	 4					per apparecchi 412 352 029 0, 412 352 030 0
		1	A, B, C, D	M = 25 ± 2 Nm		Assicurarsi prima dell'operazione di lavoro successiva che tutte le viti abbiano la corretta coppia di serraggio.
		2	A, B, C, D		90° + 10° /-5°	
		3	E, F, G, H			Svitare la vite. 180°
		4	E, F, G, H	M = 10 ± 2 Nm		Assicurarsi prima dell'operazione di lavoro successiva che tutte le viti abbiano la corretta coppia di serraggio.
		5	E, F, G, H		120° + 10° /-5°	
<b>1</b>						Osservare la posizione di montaggio.

nl

## Symbolen & trefwoorden











-  **DANGER** RISICO Direct gevaarlijke situatie: ernstig lichamelijk letsel of dood als gevolg
-  **WARNING** VOORZICHTIG Mogelijk gevaarlijke situatie: licht of middelmatig lichamelijk letsel of verlies van materiaal als gevolg.
-  **CAUTION** WAARSCHUWING Mogelijk gevaarlijke situatie: ernstig lichamelijk letsel of dood als gevolg
-  Componenten met een omcirkeld itemnummer zitten in de reparatieset.
-  Draaihoek.

-  Instructie/informatie voor reparatie op de juiste wijze
-  De reparatieset kan voor de componenten volgens de tabel worden gebruikt..
-  Draai het element met het aangegeven aanhaalmoment resp. de aangegeven draaihoek aan.
- NOTE** Instructie/informatie voor reparatie op de juiste wijze

## Algemene reparatieaanwijzingen





1. Alleen gekwalificeerd personeel van een gespecialiseerde werkplaats is bevoegd reparatiewerkzaamheden uit te voeren aan componenten van voertuig-veiligheidssystemen.
2. Volg de richtlijnen en aanwijzingen van de voertuigfabrikant onvoorwaardelijk op.
3. Houdt u ter voorkoming van ongevallen aan de voorschriften van zowel het bedrijf als de overheid.
4. Gebruik uitsluitend vervangingsdelen die door WABCO of de voertuigfabrikant zijn vrijgegeven.
5. Begin reparatiewerkzaamheden altijd pas nadat u alle benodigde informatie heeft gelezen en begrepen. Benodigde documenten: Testvoorschriften, onderdelenlijst, algemene reparatie- en testaanwijzingen (815 010 109 3), die u kan vinden op [www.wabco-auto.com](http://www.wabco-auto.com) door het productnummer of publicatienummer in te geven in INFORM
6. Controleer elk gerepareerd component - volgens de testinstructies - op een testbank of soortgelijke installatie op juiste afstelling, werking en dichtheid.
7. WABCO aanvaardt geen aansprakelijkheid of verantwoordelijkheid voor het functioneren en de kwaliteit van een gerepareerd apparaat.

## Volgorde van montage

Afbeelding	Symbol	Procedure	Volgorde:	Aanhaalmoment:	Draaihoek:	Opmerking
<b>1+3</b>	 1, 3					voor componenten 412 704 019 0, 412 704 024 0, 412 704 025 0
		1	A, B, C, D, E, F	M = 20 ± 2 Nm		Controleer voor de volgende stap, dat alle schroeven goed zijn aangedraaid.
		2.1	A, B, C, D, E, F		90° + 10° /-5°	
		2.2	A, B, C, D, E, F		90° + 10° /-5°	
		3	G, H			Draai de schroef los. 180°
		4	G, H	M = 7 ± 2 Nm		
		5	G, H		180° + 10° /-5°	
<b>1+2</b>	 2	1	A, B	M = 6 ± 0.6 Nm		
		2	A, B		70° + 15° /-5°	
<b>4</b>	 4					voor componenten 412 352 029 0, 412 352 030 0
		1	A, B, C, D	M = 25 ± 2 Nm		Controleer voor de volgende stap, dat alle schroeven goed zijn aangedraaid.
		2	A, B, C, D		90° + 10° /-5°	
		3	E, F, G, H			Draai de schroef los. 180°
		4	E, F, G, H	M = 10 ± 2 Nm		Controleer voor de volgende stap, dat alle schroeven goed zijn aangedraaid.
		5	E, F, G, H		120° + 10° /-5°	
<b>1</b>						Let op inbouwpositie.

pl

## Hasła ostrzegawcze i symbole

-  **DANGER** NIEBEZPIECZEŃSTWO Bezpośrednie zagrożenie ciężkimi obrażeniami bądź śmiercią.
-  **WARNING** UWAGA! Niebezpieczeństwo grożące lekkimi bądź średnimi obrażeniami.
-  **CAUTION** OSTRZEŻENIE Niebezpieczeństwo grożące śmiercią bądź ciężkimi obrażeniami.
-  Części oznaczone kółkiem wokół numeru pozycji należą do zestawu naprawczego.
-  Kąt obrotu.

 Wskazówki / Informacje dotyczące poprawnej naprawy.

 Zestaw naprawczy może być używany do urządzeń według tabeli.











 Dokręcić element podanym momentem obrotowym.

**NOTE** Wskazówki / Informacje dotyczące poprawnej naprawy.

## Ogólne porady naprawcze





1. Prace naprawcze w obrębie urządzeń układu bezpieczeństwa pojazdu mogą być wykonane jedynie przez wykwalifikowany personel specjalistycznego warsztatu.
2. Należy koniecznie postępować według wytycznych i wskazówek producenta pojazdu.
3. Należy przestrzegać zakładowych i krajowych przepisów BHP.
4. Należy używać wyłącznie części zamiennych dopuszczonych przez firmę WABCO bądź przez producenta pojazdu.
5. Naprawę należy rozpocząć dopiero wówczas, gdy wszystkie potrzebne do niej informacje zostaną przeczytane i zrozumiane. Dokumenty potrzebne dodatkowo: instrukcja kontrolna, tabela części zamiennych, ogólne wskazówki dotyczące naprawy i kontroli (815 020 109 3) znajdują Państwo na stronie internetowej [www.wabco-auto.com](http://www.wabco-auto.com), podając numer urządzenia bądź numer publikacji w bazie INFORM.
6. Na odpowiednim urządzeniu należy sprawdzić każde naprawiane urządzenie - zgodnie z instrukcją kontrolną - pod kątem sprawności działania i szczelności.
7. WABCO nie udziela żadnej gwarancji na działanie lub jakość naprawionego urządzenia.

## Kolejność montażu

Obraz	Symbol	Czynność	Kolejność:	Moment dokręcania:	Kąt obrotu:	Komentarz
<b>1+3</b>	 1, 3					do urządzeń 412 704 019 0, 412 704 024 0, 412 704 025 0
		1	A, B, C, D, E, F	M = 20 ± 2 Nm		Sprawdź właściwy moment we wszystkich śrubach przed przystąpieniem do następnego kroku.
		2.1	A, B, C, D, E, F		90° +10° /-5°	
		2.2	A, B, C, D, E, F		90° +10° /-5°	
		3	G, H			Odkręcić śrubę. 180°
		4	G, H	M = 7 ± 2 Nm		
		5	G, H		180° + 10° /-5°	
<b>1+2</b>	 2	1	A, B	M = 6 ± 0.6 Nm		
		2	A, B		70° + 15° /-5°	
<b>4</b>	 4					do urządzeń 412 352 029 0, 412 352 030 0
		1	A, B, C, D	M = 25 ± 2 Nm		Sprawdź właściwy moment we wszystkich śrubach przed przystąpieniem do następnego kroku.
		2	A, B, C, D		90° + 10° /-5°	
		3	E, F, G, H			Odkręcić śrubę. 180°
		4	E, F, G, H	M = 10 ± 2 Nm		Sprawdź właściwy moment we wszystkich śrubach przed przystąpieniem do następnego kroku.
		5	E, F, G, H		120° + 10° /-5°	
<b>1</b>						Zwrócić uwagę na położenie montażowe.

ru

## Знаки & символы

-  **DANGER** ОПАСНО Прямая угроза аварийной ситуации: влечет за собой смерть или тяжелые повреждения
-  **WARNING** ОСТОРОЖНО Опасная ситуация: последствиями являются легкие повреждения или повреждения средней тяжести, а также материальный ущерб
-  **CAUTION** ПРЕДУПРЕЖДЕНИЕ Опасная ситуация: влечет за собой смерть или тяжелые повреждения
-  Номера частей, обведенные кружком, Вы найдете в ремкомплекте.
-  Угол вращения.

 Указание/информация для проведения надлежащего ремонта

 Ремкомплект может быть использован для приборов соответственно таблице.











 Затянуть элемент с заданным моментом затяжки или на заданный угол поворота.

**NOTE** Указание/информация для проведения надлежащего ремонта

## Общие указания по ремонту





1. Провождение ремонта приборов данной системы должно производиться только квалифицированным персоналом в специализированной мастерской.
3. Соблюдайте предписания предприятия по технике безопасности, а также национальные нормы.
5. Проводите ремонт только после того, как вы прочитали и поняли все информации, необходимые для данного процесса. Дополнительные документы: инструкция по тестированию, список запасных частей, общие инструкции по ремонту и проведению испытаний (815 080 109 3) Вы найдете на [www.wabco-auto.com](http://www.wabco-auto.com). Для этого необходимо задать номер нужного прибора или номер брошюры в INFORM.
7. Компания WABCO не принимает на себя какую-либо ответственность за работу или качество отремонтированных устройств.
2. Следуйте предписаниям и инструкциям изготовителя транспортного средства.
4. Используйте только запчасти, допущенные к использованию компанией Wabco или производителем транспортного средства.
6. Проконтролируйте каждый отремонтированный прибор- согласно инструкции по тестированию- на работоспособность и герметичность с помощью соответствующего оборудования.



## Порядок действий при монтаже.

Изображение	Символ	Порядок действия	Последовательность:	Момент сопротивления:	Угол вращения:	Замечания
<b>1+3</b>	 1, 3					для приборов 412 704 019 0, 412 704 024 0, 412 704 025 0
		1	A, B, C, D, E, F	M = 20 ± 2 Nm		Перед следующим этапом работ убедитесь в том, что для всех винтов применен соответствующий момент затяжки.
		2.1	A, B, C, D, E, F		90° + 10° / -5°	
		2.2	A, B, C, D, E, F		90° + 10° / -5°	
		3	G, H			отвинтите болт. 180°
		4	G, H	M = 7 ± 2 Nm		
		5	G, H		180° + 10° / -5°	
<b>1+2</b>	 2	1	A, B	M = 6 ± 0.6 Nm		
		2	A, B		70° + 15° / -5°	
<b>4</b>	 4					для приборов 412 352 029 0, 412 352 030 0
		1	A, B, C, D	M = 25 ± 2 Nm		Перед следующим этапом работ убедитесь в том, что для всех винтов применен соответствующий момент затяжки.
		2	A, B, C, D		90° + 10° / -5°	
		3	E, F, G, H			отвинтите болт. 180°
		4	E, F, G, H	M = 10 ± 2 Nm		Перед следующим этапом работ убедитесь в том, что для всех винтов применен соответствующий момент затяжки.
		5	E, F, G, H		120° + 10° / -5°	
<b>1</b>						Обратите внимание на местоположение при монтаже.

SV

## Signalord & symboler











-  **DANGER** FARA Omedelbar risk: svåra personskador eller dödsfall
-  **WARNING** VARNING Möjlig risk: Lätta eller medelsvåra personskador eller materiella skador
-  **CAUTION** VARNING Möjlig risksituation: Dödsfall eller svåra personskador
-  Delar med inringat positionsnummer ingår i reparationssetsen.
-  Åtdragningsvinkel.

-  Anvisningar/information för korrekt reparation
-  Reparationssetsen kan användas för apparater enligt tabellen.
-  Dra åt elementet med angivet vridmoment resp. angiven vridvinkel.
- NOTE** Anvisningar/information för korrekt reparation

## Allmänna reparationsanvisningar





1. Reparationsarbeten på enheter i fordonssäkerhetssystem får endast genomföras av kvalificerad personal på behörig verkstad.
3. Följ alltid företagets föreskrifter för förebyggande av olycksfall samt gällande nationella föreskrifter.
5. Börja inte med reparationsarbetena förrän du har läst igenom och förstått all nödvändig information. Nödvändiga extradokument: Kontrollanvisning, reservdelsblad, allmän reparation och kontrollinformation (815 070 109 3). Du hittar dokumenten på [www.wabco-auto.com](http://www.wabco-auto.com) genom att mata in apparatens produktnummer eller dokumentnummer i INFORM.
7. WABCO ansvarar inte för reparerade enheters funktion eller kvalitet.
2. Beakta alltid fordonstillverkarens specifikationer och anvisningar.
4. Används endast reservdelar som är godkända av WABCO eller fordonstillverkaren.
6. Varje reparerad apparat ska kontrolleras på funktionsduglighet och täthet på en lämplig anordning enligt kontrollanvisningen.



## Ordningsföljd för montering

Bild	Symbol	Arbetssteg	Ordningsföljd:	Åtdragningsmoment:	Åtdragningsvinkel:	Kommentar
<b>1+3</b>	 1, 3					för apparater 412 704 019 0, 412 704 024 0, 412 704 025 0
		1	A, B, C, D, E, F	M = 20 ± 2 Nm		Kontrollera att alla skruvar har rätt åtdragningsmoment innan du går vidare till nästa arbetsmoment.
		2.1	A, B, C, D, E, F		90° +10° /-5°	
		2.2	A, B, C, D, E, F		90° +10° /-5°	
		3	G, H			Lossa skruven. 180°
		4	G, H	M = 7 ± 2 Nm		
		5	G, H		180° + 10° /-5°	
<b>1+2</b>	 2	1	A, B	M = 6 ± 0.6 Nm		
		2	A, B		70° + 15° /-5°	
<b>4</b>	 4					för apparater 412 352 029 0, 412 352 030 0
		1	A, B, C, D	M = 25 ± 2 Nm		Kontrollera att alla skruvar har rätt åtdragningsmoment innan du går vidare till nästa arbetsmoment.
		2	A, B, C, D		90° + 10° /-5°	
		3	E, F, G, H			Lossa skruven. 180°
		4	E, F, G, H	M = 10 ± 2 Nm		Kontrollera att alla skruvar har rätt åtdragningsmoment innan du går vidare till nästa arbetsmoment.
		5	E, F, G, H		120° + 10° /-5°	
<b>1</b>						Beakta monteringsläget.

zh

## Symbols & Signal Words

-  **DANGER** 危险! 直接危险: 导致个人严重伤害或死亡
-  **WARNING** 小心! 可能危险: 导致较小或一般程度人员伤害或物品损失
-  **CAUTION** 警告! 可能危险: 导致个人严重伤害或死亡
-  修包中包含号码带有圆圈的零件。
-  旋转角度。





-  用于正确维修的指导和信息。
-  根据表格所示, 修包可以用于相应的总成维修。
-  用给定的扭矩及转角上紧元件。
- NOTE** 用于正确维修的指导和信息。

1. 仅有在专业维修店的有资质的人员被授权执行车辆安全系统的维修工作。
3. 遵循公司的相关事故预防条例和国家法规。
5. 当你已经阅读并已理解维修所需要的所有信息后, 才能开始维修工作。此外需要的信息: 试验指导, 备件清单, 通用维修和试验提示 (815 010 109 3) 可以在 [www.wabco-auto.com](http://www.wabco-auto.com) 找到。只需在其上键入产品号码或INFORM中的出版物号码。
7. WABCO对经过修理的设备的功能或质量不承担任何责任。
2. 完全遵循车辆制造商的规格和安装指导。
4. 仅使用于由威伯科公司或整车制造商发布的备件产品。
6. 根据试验要求在适当的设备上, 检测每个维修设备的功效和紧密性。

图片	符号	程序	顺序:	扭矩:	旋转角度:	注释
<b>1+3</b>	 1, 3					用于产品 412 704 019 0, 412 704 024 0, 412 704 025 0
		1	A, B, C, D, E, F	M = 20 ± 2 Nm		请在进行下一步工作前确证所有螺钉均具有正确的拧紧力矩。
		2.1	A, B, C, D, E, F		90° +10° /-5°	
		2.2	A, B, C, D, E, F		90° +10° /-5°	
		3	G, H			松开螺钉。180°
		4	G, H	M = 7 ± 2 Nm		
		5	G, H		180° + 10° /-5°	
<b>1+2</b>	 2	1	A, B	M = 6 ± 0.6 Nm		
		2	A, B		70° + 15° /-5°	
<b>4</b>	 4					用于产品 412 352 029 0, 412 352 030 0
		1	A, B, C, D	M = 25 ± 2 Nm		请在进行下一步工作前确证所有螺钉均具有正确的拧紧力矩。
		2	A, B, C, D		90° + 10° /-5°	
		3	E, F, G, H			松开螺钉。180°
		4	E, F, G, H	M = 10 ± 2 Nm		请在进行下一步工作前确证所有螺钉均具有正确的拧紧力矩。
		5	E, F, G, H		120° + 10° /-5°	
<b>1</b>						观察安装位置。

el

## Προειδοποιητικές λέξεις & Σύμβολα

-  **DANGER** ΚΙΝΔΥΝΟΣ! Άμεσα επαπειλούμενος κίνδυνος: Σοβαρές σωματικές βλάβες ή θάνατος
-  **WARNING** ΠΡΟΣΟΧΗ! Πιθανή επικίνδυνη κατάσταση: Ελαφρές ή μεσαίας έκτασης σωματικές βλάβες ή υλικές βλάβες
-  **CAUTION** ΠΡΟΕΙΔΟΠΟΙΗΣΗ! Πιθανή επικίνδυνη κατάσταση: Θάνατος ή σοβαρές σωματικές βλάβες
-  Εξαρτήματα με έναν κύκλο γύρω από τον αριθμό θέσης περιλαμβάνονται στο κιτ επισκευής.
-  Γωνία περιστροφής συνέχισης.

 Οδηγίες / πληροφορίες για την ορθή επισκευή

 Το κιτ επισκευής μπορεί να χρησιμοποιηθεί για συσκευές αναλόγως του πίνακα.











 Σφίξτε το στοιχείο με τη δεδομένη ροπή στρέψης ή γωνία περιστροφής.

**NOTE** Οδηγίες / πληροφορίες για την ορθή επισκευή

## Γενικές υποδείξεις επισκευής

1. Εργασίες επισκευής σε συσκευές ενός συστήματος ασφαλείας οχημάτων επιτρέπονται μόνο από εκπαιδευμένο εξειδικευμένο προσωπικό ειδικού συνεργείου.
3. Τηρείτε τους κανονισμούς πρόληψης ατυχημάτων της επιχείρησης, καθώς και τις εθνικές διατάξεις.
5. Ξεκινάτε την επισκευή μόνο αφού έχετε αναγνώσει και κατανοήσει όλες τις πληροφορίες που είναι απαραίτητες για την επισκευή. Επιπροσθέτως απαιτούμενα έγγραφα: Οδηγίες ελέγχου, Φύλλο ανταλλακτικών, Γενικές υποδείξεις επισκευής και ελέγχου (815 200 109 3), θα τα βρείτε στη σελίδα [www.wabco-auto.com](http://www.wabco-auto.com), εισάγοντας τον κωδικό προϊόντος της συσκευής και/ή τον αριθμό του εντύπου στον κατάλογο προϊόντων INFORM.
7. Η WABCO δεν φέρει καμία ευθύνη για τη λειτουργία ή την ποιότητα μίας επισκευασμένης συσκευής.
2. Τηρείτε οπωσδήποτε τις οδηγίες και τις επισημάνσεις του κατασκευαστή του οχήματος.
4. Χρησιμοποιείτε αποκλειστικά ανταλλακτικά της WABCO ή του κατασκευαστή του οχήματος.
6. Ελέγχετε τη λειτουργικότητα και στεγανότητα κάθε επισκευασμένης συσκευής - σύμφωνα με τις οδηγίες ελέγχου - σε μια κατάλληλη διάταξη.

## Ακολουθία τοποθέτησης

Εικόνα	Σύμβολο	Βήμα εργασίας	Ακολουθία (σειρά):	Ροπή σύσφιξης:	Γωνία περιστροφής συνέχισης:	Παρατηρήσεις
<b>1+3</b>	 1, 3					για εργαλεία 412 704 019 0, 412 704 024 0, 412 704 025 0
		1	A, B, C, D, E, F	M = 20 ± 2 Nm		Διασφαλίστε πριν από τη διενέργεια του επόμενου βήματος εργασίας όλες οι βίδες να έχουν συσφιχτεί με τη σωστή ροπή σύσφιξης.
		2.1	A, B, C, D, E, F		90° + 10° /-5°	
		2.2	A, B, C, D, E, F		90° + 10° /-5°	
		3	G, H			Λύστε τη βίδα. 180°
		4	G, H	M = 7 ± 2 Nm		
		5	G, H		180° + 10° /-5°	
<b>1+2</b>	 2	1	A, B	M = 6 ± 0.6 Nm		
		2	A, B		70° + 15° /-5°	
<b>4</b>	 4					για εργαλεία 412 352 029 0, 412 352 030 0
		1	A, B, C, D	M = 25 ± 2 Nm		Διασφαλίστε πριν από τη διενέργεια του επόμενου βήματος εργασίας όλες οι βίδες να έχουν συσφιχτεί με τη σωστή ροπή σύσφιξης.
		2	A, B, C, D		90° + 10° /-5°	
		3	E, F, G, H			Λύστε τη βίδα. 180°
		4	E, F, G, H	M = 10 ± 2 Nm		Διασφαλίστε πριν από τη διενέργεια του επόμενου βήματος εργασίας όλες οι βίδες να έχουν συσφιχτεί με τη σωστή ροπή σύσφιξης.
		5	E, F, G, H		120° + 10° /-5°	
<b>1</b>						Προσοχή στη θέση τοποθέτησης.

tr

## Semboller&amp;belirti sözleri

- ⚠ DANGER** TEHLİKE Tehlikeli durum: ciddi personel yaralanması veya ölüm riski.
- ⚠ WARNING** DİKKAT Tehlike riski: hafif personel yaralanması veya maddi zarar.
- ⚠ CAUTION** UYARI Ciddi personel yaralanması veya ölüm riski.
- Yuvarlak içinde numarası belirtilen parça numaraları kit içerisinde bulunur.
- ↻ Dönüş açısı.

**i** Talimat/ Doğru tamir için bilgi

**🔧** Tabloda belirtilen parçalar için kit kullanılabilir.

**T** Elemanı belirtilen sıkma torku ya da dönme açısı ile sıkın.

**NOTE** Talimat/ Doğru tamir için bilgi

## Genel tamir bilgisi

- Araçların güvenlik sistemlerinde tamir işlemlerini yalnızca eğitim almış konusunda uzman personeller gerçekleştirebilir.
- Şirket emniyet kuralları ve ulusal regülasyonlarına uyunuz.
- Tamire, tamir işlemi için gerekli olan tüm bilgileri okuyup anladıktan sonra başlayınız. Ayrıca gerekli olan dokümanlar: Test talimatı, yedek parça sayfası, genel tamir ve test bilgileri (815 140 109 3). Tümünü linki altında, online ürün kataloğu INFORM'da cihaza ait ürün numarasını veya baskı numarasını girerek bulabilirsiniz.
- WABCO tamir edilmiş bir cihazın işlevselliği veya kalitesi için hiçbir sorumluluk üstlenmemektedir.
- Araç üretici firma özellikler ve talimatlarına kesinlikle uyunuz.
- Sadece WABCO veya üretici firma tarafından yayınlanan yedek parçaları kullanın.
- Tamir edilmiş her cihazı - test talimatına uygun şekilde - uygun bir donanımla işlevsellik ve sızdırmazlık konusunda kontrol edin.





## Montaj sırası

Resim	Sembol	Prosedür	Sıra:	Tork:	Dönüş açısı:	Yorumlar
<b>1+3</b>	<b>T</b> 1, 3					Cihazlar için 412 704 019 0, 412 704 024 0, 412 704 025 0
		1	A, B, C, D, E, F	M = 20 ± 2 Nm		Bir sonraki iş adımıdan önce, tüm cıvataların doğru torka sahip olduklarından emin olun.
	↻	2.1	A, B, C, D, E, F		90° +10° /-5°	
	↻	2.2	A, B, C, D, E, F		90° +10° /-5°	
	↻	3	G, H			Vidayı sökün.180°
		4	G, H	M = 7 ± 2 Nm		
	↻	5	G, H		180° + 10° /-5°	
<b>1+2</b>	<b>T</b> 2					
		1	A, B	M = 6 ± 0.6 Nm		
		2	A, B		70° + 15° /-5°	
<b>4</b>	<b>T</b> 4					Cihazlar için 412 352 029 0, 412 352 030 0
		1	A, B, C, D	M = 25 ± 2 Nm		Bir sonraki iş adımıdan önce, tüm cıvataların doğru torka sahip olduklarından emin olun.
	↻	2	A, B, C, D		90° + 10° /-5°	
	↻	3	E, F, G, H			Vidayı sökün. 180°
		4	E, F, G, H	M = 10 ± 2 Nm		Bir sonraki iş adımıdan önce, tüm cıvataların doğru torka sahip olduklarından emin olun.
	↻	5	E, F, G, H		120° + 10° /-5°	
<b>1</b>	<b>i</b>					Montaj konumuna dikkat.





hu

## Szimbólumok és Jelző Szavak

-  **DANGER** Közelgő vészhelyzet: súlyos személyi sérüléshez vagy halálhoz vezethet
-  **WARNING** Lehetséges vészhelyzet: kisebb vagy közepes személyi sérülés vagy anyagi kár keletkezhet
-  **CAUTION** Lehetséges vészhelyzet: súlyos személyi sérüléshez vagy halálhoz vezethet
-  Csak azok az alkatrészek amik be vannak karikázva, részei a javítókészletnek.
-  Elfordulási szög.

 Utasítás / Információ a helyes szereléshez

 A javító készlet a táblázatban szereplő egységekhez használható.











 Az elemet a megadott meghúzási nyomatékkal, ill. forgásszöggel húzza meg.

**NOTE** Utasítás / Információ a helyes szereléshez

## Általános Javítási Tippek





1. Csak megfelelő végzettségű személy vagy szakműhely van felhatalmazva hogy a jármű biztonsági rendszerén javítást eszközöljön.
3. Mindenképpen vegye figyelembe a gyártók vonatkozó balesetvédelmi előírásait és a nemzeti előírásokat is.
5. Minden esetben csak akkor kezdjen hozzá a javítási munkához, ha elolvasta és teljesen megértette a javítási utasítást! Ezekre a dokumentumokra lesz még szüksége: Vizsgálati Utasítás, Alkatrészek listája, Általános javítási és vizsgálati tippek (815 010 109 3) amiket a [www.wabco-auto.com](http://www.wabco-auto.com)-on talál meg, a termék vagy a kiadvány cikkszámának begépelésével az INFORM-ba.
7. A WABCO nem vállal felelősséget a javított készülékek működéséért és minőségéért.
2. Mindenképpen kövesse a jármű gyártójának specifikációját és szerelési utasításait.
4. Csak a WABCO vagy a jármű gyártója által kereskedelmi forgalomban lévő alkatrészeket használjon.
6. Minden javított egységnél ellenőrizze a működési üzemiállapotokat és az előírt meghúzási nyomatékokat a vizsgálati utasításnak megfelelően.



## Szerelési sorrend

Kép	Szimbólum	Eljárás	Sorrend	Nyomaték	Elfordulási szög:	Megjegyzés
<b>1+3</b>	 1, 3					eszközöknek 412 704 019 0, 412 704 024 0, 412 704 025 0
		1	A, B, C, D, E, F	M = 20 ± 2 Nm		A következő munkalépés előtt győződjön meg arról, hogy minden csavar esetében megfelelő meghúzási nyomatékot alkalmaz.
		2.1	A, B, C, D, E, F		90° +10° /-5°	
		2.2	A, B, C, D, E, F		90° +10° /-5°	
		3	G, H			Csavar oldása 180°
		4	G, H	M = 7 ± 2 Nm		
		5	G, H		180° + 10° /-5°	
<b>1+2</b>	 2	1	A, B	M = 6 ± 0.6 Nm		
		2	A, B		70° + 15° /-5°	
<b>4</b>	 4					eszközöknek 412 352 029 0, 412 352 030 0
		1	A, B, C, D	M = 25 ± 2 Nm		A következő munkalépés előtt győződjön meg arról, hogy minden csavar esetében megfelelő meghúzási nyomatékot alkalmaz.
		2	A, B, C, D		90° + 10° /-5°	
		3	E, F, G, H			Csavar oldása 180°
		4	E, F, G, H	M = 10 ± 2 Nm		A következő munkalépés előtt győződjön meg arról, hogy minden csavar esetében megfelelő meghúzási nyomatékot alkalmaz.
		5	E, F, G, H		120° + 10° /-5°	
<b>1</b>						Tartsa meg a beszerelési helyzetet

pt

## Símbolos e Significados

-  **DANGER** Perigo! Risco de acidente iminente: lesão corporal grave e/ou risco de morte.
-  **WARNING** Cuidado! Possível situação de acidente: ferimentos leves/moderados e/ou danos materiais.
-  **CAUTION** Atenção! Possível situação de acidente: lesão corporal grave e/ou risco de morte.
-  Componentes que estão marcados com um círculo compõem o jogo de reparo.
-  Ângulo de rotação.











-  Instrução/Informação para uma correta reparação.
-  O jogo de reparo pode ser utilizado nos produtos relacionados na tabela.
-  Apertar o elemento com o binário ou o ângulo de rotação indicado.

**NOTE** Instrução/Informação para uma correta reparação.

## Dicas Gerais para Reparação





1. Por motivo de segurança, somente pessoas qualificadas devem efetuar reparação nos sistemas de freio do veículo.
3. Mantenha e siga as orientações de prevenção de acidentes vigentes e/ou impostas pelos órgãos competentes.
5. Somente inicie o trabalho de reparação após ler e entender todas as informações necessárias para realizar uma reparação. Documentos adicionais necessários: instrução de teste, lista de peças sobressalentes, dicas gerais de testes e reparação (815 130 109 3) podem ser encontrados no site [www.wabco-auto.com](http://www.wabco-auto.com) ao inserir o número do produto.
7. A WABCO não assume qualquer responsabilidade pela função ou qualidade de um equipamento reparado.
2. Siga sempre as recomendações/especificações do fabricante do veículo.
4. Use somente peças de reposição aprovadas pela WABCO ou pelo fabricante do veículo.
6. Verificar cada produto reparado conforme instruções de teste, utilizando os equipamentos necessários e local adequado.



## Sequência de montagem

Figura	Símbolo	Procedimento	Sequência:	Torque:	Ângulo de rotação:	Comentários
<b>1+3</b>	 1, 3					Para conjuntos 412 704 019 0, 412 704 024 0, 412 704 025 0
		1	A, B, C, D, E, F	M = 20 ± 2 Nm		O manuseamento deste componente requer uma proteção contra a descarga eletrostática (ESD).
		2.1	A, B, C, D, E, F		90° +10° /-5°	
		2.2	A, B, C, D, E, F		90° +10° /-5°	
		3	G, H			Desparafusar o parafuso 180°
		4	G, H	M = 7 ± 2 Nm		
		5	G, H		180° + 10° /-5°	
<b>1+2</b>	 2	1	A, B	M = 6 ± 0.6 Nm		
		2	A, B		70° + 15° /-5°	
<b>4</b>	 4					Para conjuntos 412 352 029 0, 412 352 030 0
		1	A, B, C, D	M = 25 ± 2 Nm		O manuseamento deste componente requer uma proteção contra a descarga eletrostática (ESD).
		2	A, B, C, D		90° + 10° /-5°	
		3	E, F, G, H			Desparafusar o parafuso 180°
		4	E, F, G, H	M = 10 ± 2 Nm		O manuseamento deste componente requer uma proteção contra a descarga eletrostática (ESD).
		5	E, F, G, H		120° + 10° /-5°	
<b>1</b>						Observar a posição de montagem

ro

## Simboluri și cuvinte pentru avertizare

-  **DANGER** Situație de pericol iminentă: poate rezulta vătămare corporală gravă sau deces.
-  **WARNING** Posibilă situație de pericol: pot rezulta vătămări corporale minore sau medii sau pagube materiale
-  **CAUTION** Posibilă situație de pericol: poate rezulta vătămare corporală gravă sau deces
-  Pieșele cu numărul de articol încercuit sunt incluse în kit.
-  Unghi de rotire.











-  Instrucțiuni / Informare pentru o reparare corectă
-  Kitul poate fi folosit pentru dispozitive, conform tabelului.
-  Strângeți elementul cu cuplul, respectiv unghiul de rotire indicat.

**NOTE** Instrucțiuni / Informare pentru o reparare corectă

## Instrucțiuni generale referitoare la reparație





1. Numai personalul calificat al unui atelier de service specializat este autorizat să efectueze lucrări de reparații pe sistemul de siguranță al vehiculului.
2. Respectați obligatoriu instrucțiunile date de producătorul vehiculului.
3. Respectați prevederile firmei și cele naționale pentru prevenirea accidentelor.
4. Utilizați exclusiv piese de schimb autorizate de WABCO sau de producătorul autovehiculului.
5. Întotdeauna începeți lucrările de reparații numai după ce ați citit și înțeles toate informațiile necesare pentru reparație. Documente suplimentare necesare: Instrucțiuni de testare, Lista pieselor de schimb, Instrucțiuni generale pentru reparare și testare (815 110 109 3) pot fi găsite pe [www.wabco-auto.com](http://www.wabco-auto.com) introducând codul dispozitivului în INFORM.
6. Verifică eficiența funcțională și etanșeitățile fiecărui echipament reparat pe o instalație adecvată în conformitate cu instrucțiunile de testare.
7. WABCO nu garantează sau nu răspunde pentru funcționarea și calitatea unui dispozitiv reparat.



## Secvența asamblării

Imagine	Simbol	Procedură	Secvență:	Moment de torsiune:	Unghi de rotire:	Comentarii
<b>1+3</b>	 1, 3					pentru dispozitive 412 704 019 0, 412 704 024 0, 412 704 025 0
		1	A, B, C, D, E, F	M = 20 ± 2 Nm		Înainte de următoarea etapă de lucru, asigurați-vă că toate șuruburile au momentul de strângere corect.
		2.1	A, B, C, D, E, F		90° +10° /-5°	
		2.2	A, B, C, D, E, F		90° +10° /-5°	
		3	G, H			Deblocați șurubul.180°
		4	G, H	M = 7 ± 2 Nm		
		5	G, H		180° + 10° /-5°	
<b>1+2</b>	 2	1	A, B	M = 6 ± 0.6 Nm		
		2	A, B		70° + 15° /-5°	
<b>4</b>	 4					pentru dispozitive 412 352 029 0, 412 352 030 0
		1	A, B, C, D	M = 25 ± 2 Nm		Înainte de următoarea etapă de lucru, asigurați-vă că toate șuruburile au momentul de strângere corect.
		2	A, B, C, D		90° + 10° /-5°	
		3	E, F, G, H			Deblocați șurubul. 180°
		4	E, F, G, H	M = 10 ± 2 Nm		Înainte de următoarea etapă de lucru, asigurați-vă că toate șuruburile au momentul de strângere corect.
		5	E, F, G, H		120° + 10° /-5°	
<b>1</b>						Observați poziția de instalare.







## ko

### Symbols & Signal Words

-  **DANGER** 급박한 위험 상황: 심각한 상해 또는 사망에 이르게 할 수도 있습니다.
-  **WARNING** 잠재적 위험 상황: 경미하거나 완화된 부상 또는 물질적 손실을 입을 수 있습니다.
-  **CAUTION** 잠재적 위험 상황: 심각한 상해 또는 사망에 이르게 할 수도 있습니다.
-  본 키트에는 원숫자로 표기된 제품들만 포함되어 있습니다.
-  회전 각도.

-  올바른 수리를 위한 설명 / 정보
-  표를 참조하여 제품에 대한 키트를 사용하실 수 있습니다.
-  제시된 토크 및 회전각으로 요소를 조이십시오.
- NOTE** 올바른 수리를 위한 설명 / 정보

1. 자격이 있는 전문 정비사만이 차량의 안전 시스템을 수리하실 수 있습니다.
3. 회사의 사고예방 규제와 국내 법적 규제를 지키십시오.
5. 항상 수리에 필요한 모든 정보를 읽고 이해했을 때만 작업을 시작하십시오. 추가적으로 필요한 간행물: 검사지침, 예비부품 리스트, 일반적인 수리 및 검사 참고사항 (815 010 109 3)은 와브코 홈페이지 [www.wabco-auto.com](http://www.wabco-auto.com)의 INFORM으로 들어가셔서 제품번호 또는 간행물 번호를 조회하여 찾으실 수 있습니다.
7. 와브코는 수리된 제품의 품질과 기능에 대해 어떠한 책임도 지지 않습니다.
2. 꼭 차량제조사 사양과 지침서를 따르십시오.
4. 와브코 또는 차량 제조사로부터 제공된 예비부품만을 사용하십시오.
6. 기능적 효율과 견고함을 위해 검사지침에 따라 각 수리장비들을 적절한 설비위에서 체크해 보시기 바랍니다.

그림	기호	절차	순서:	토크:	회전 각도:	주석
<b>1+3</b>	 1, 3					제품에 한함. 412 704 019 0, 412 704 024 0, 412 704 025 0
		1	A, B, C, D, E, F	M = 20 ± 2 Nm		다음 절차를 실행하기 전에 모든 나사에 정확한 토크가 주어졌는지 확인하십시오.
		2.1	A, B, C, D, E, F		90° + 10° / -5°	
		2.2	A, B, C, D, E, F		90° + 10° / -5°	
		3	G, H			나사를 풀어 주십시오. 180°
		4	G, H	M = 7 ± 2 Nm		
		5	G, H		180° + 10° / -5°	
<b>1+2</b>	 2	1	A, B	M = 6 ± 0.6 Nm		
		2	A, B		70° + 15° / -5°	
<b>4</b>	 4					제품에 한함. 412 352 029 0, 412 352 030 0
		1	A, B, C, D	M = 25 ± 2 Nm		다음 절차를 실행하기 전에 모든 나사에 정확한 토크가 주어졌는지 확인하십시오.
		2	A, B, C, D		90° + 10° / -5°	
		3	E, F, G, H			나사를 풀어 주십시오. 180°
		4	E, F, G, H	M = 10 ± 2 Nm		다음 절차를 실행하기 전에 모든 나사에 정확한 토크가 주어졌는지 확인하십시오.
		5	E, F, G, H		120° + 10° / -5°	
<b>1</b>						장착 위치를 준수 하십시오.