

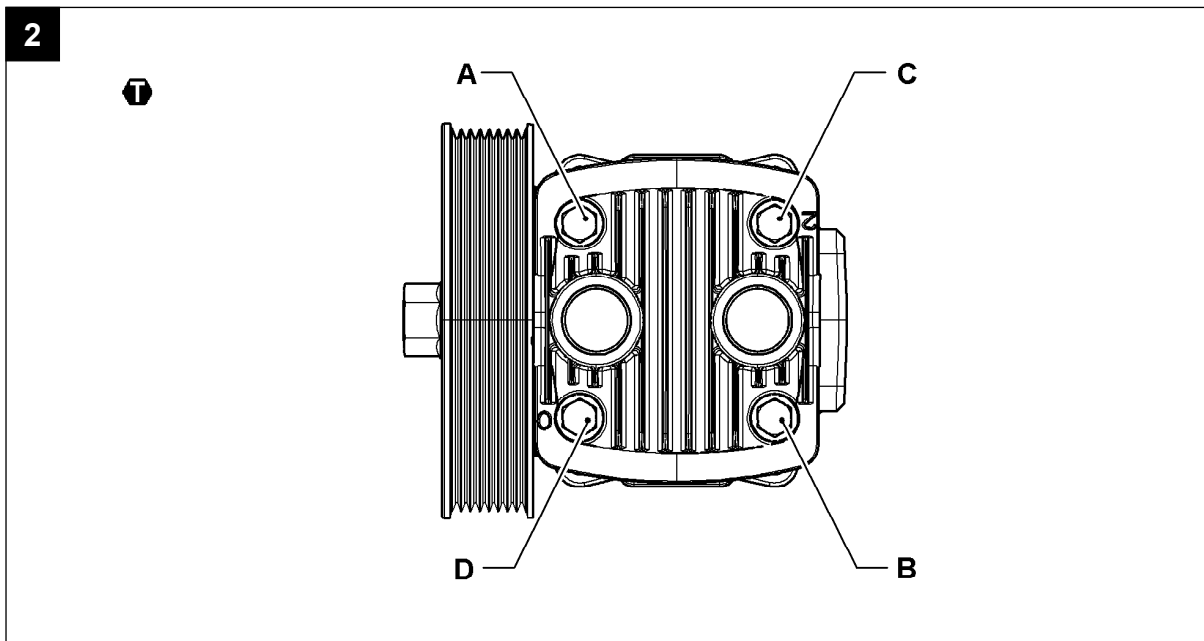







- 411 141 000 0
- 411 141 002 0
- 411 141 003 0
- 411 141 004 0
- 411 141 006 0
- ↓
- 411 141 010 0
- 411 141 501 0
- 411 141 503 0
- 411 141 504 0
- 411 141 506 0
- 411 141 507 0
- 411 141 551 0
- 411 141 552 0
- 411 141 640 0
- 411 141 702 0
- 411 141 703 0
- 411 141 800 0
- 411 141 805 0
- 411 141 818 0
- 411 141 835 0
- 411 141 845 0
- 411 141 910 0
- 411 141 930 0
- 411 145 005 0
- 411 145 010 0



Signální slova a symboly







-  **DANGER** NEBEZPEČÍ Bezprostředně hrozící nebezpečí: těžká újma na zdraví nebo smrt
-  **WARNING** POZOR Možná nebezpečná situace: jako následek lehká nebo středně těžká újma na zdraví nebo poškození majetku
-  **CAUTION** VÝSTRAHA Možná nebezpečná situace: jako následek těžká újma na zdraví nebo smrt
-  Díly, které mají číslo pozice v kroužku, jsou obsažené v opravárenské sadě.

-  Instrukce / informace ke správnému provedení opravy
-  Opravárenskou sadu je možné použít pro přístroje uvedené v tabulce.
-  Součástku utáhněte uvedeným momentem.
- NOTE** Instrukce / informace ke správnému provedení opravy





Všeobecné pokyny k opravám



1. Opravárenské práce na přístrojích systému, který má vliv na bezpečnost vozidla, smí provádět pouze kvalifikovaný personál odborné servisní dílny.
3. Dodržujte předpisy BOZP podniku a národní předpisy.
5. S opravou začněte teprve tehdy, až všechny informace nutné pro opravu přečtete a porozumíte jim. Další potřebné dokumenty: zkušební postup, list náhradních dílů, všeobecné pokyny pro opravu a kontrolu (815 150 109 3) naleznete na internetových stránkách: www.wabco-auto.com, když v databázi INFORM zadáte produktové číslo přístroje nebo číslo dokumentu.
7. WABCO nepřebírá žádnou záruku za funkci nebo kvalitu opraveného přístroje.
2. Postupujte bezpodmínečně podle pokynů a instrukcí výrobce vozidla.
4. Používejte výhradně náhradní díly od firmy WABCO nebo díly schválené výrobcem vozidla.
6. Na adekvátním zařízení přezkoušejte – podle zkušebního postupu – každý opravený přístroj na funkčnost a těsnost.

Postup montáže

Obrázek	Symbol	Pracovní operace	Pořadí:	Utahovací moment:	Úhel pootočení pro dotažení:	Poznámky
1	 1			100 ± 10 Nm		
	 2			23 + 3/0 Nm		
	 3			12 ± 1,2 Nm		
	 4		1, 2	6 ± 0,6 Nm		
	 4		1, 2		70° * 15° / - 5°	
						Dbejte na správnost montážní polohy.
2		1	A, B, C, D	20 ± 2 Nm		
		2	A, B, C, D		90° + 15° / - 5°	

Signalwörter & Symbole

-  **DANGER** GEFAHR Unmittelbar drohende Gefährdung: Schwere Personenschäden oder Tod
-  **WARNING** VORSICHT Mögliche Gefahrensituation: Leichte oder mittelschwere Personenschäden oder Sachschäden als Folge
-  **CAUTION** WARNUNG Mögliche Gefahrensituation: Tod oder schwere Personenschäden als Folge
-  Teile mit Kreis um die Positionsnummer sind im Reparatursatz enthalten.







-  Anweisung / Information für eine korrekte Reparatur
-  Der Reparatursatz kann für Geräte entsprechend Tabelle verwendet werden.
-  Element mit angegebenen Drehmoment anziehen.
- NOTE** Anweisung / Information für eine korrekte Reparatur

de

Allgemeine Reparaturhinweise





1. Reparaturarbeiten an Geräten eines Fahrzeug-Sicherheitssystems darf nur qualifiziertes Personal einer Fachwerkstatt durchführen.
2. Leisten Sie den Vorgaben und Anweisungen des Fahrzeugherstellers unbedingt Folge.
3. Halten Sie Unfallverhütungsvorschriften des Betriebes sowie nationale Vorschriften ein.
4. Verwenden Sie ausschließlich von WABCO oder vom Fahrzeughersteller freigegebene Ersatzteile.
5. Beginnen Sie die Reparatur erst dann, wenn Sie alle Informationen, die für die Reparatur notwendig sind, gelesen und verstanden haben. Zusätzlich benötigte Dokumente: Prüfanweisung, Ersatzteilblatt, Allgemeine Reparatur- und Prüfhinweise (815 020 109 3) zu finden auf www.wabco-auto.com mittels Eingabe der Produktnummer des Gerätes bzw. Druckschriftennummer in INFORM.
6. Prüfen Sie jedes reparierte Gerät – gemäß Prüfanweisung – an einer adäquaten Einrichtung auf Funktionstüchtigkeit und Dichtigkeit.
7. WABCO übernimmt keinerlei Gewährleistung für die Funktion oder Qualität eines reparierten Gerätes



Montage Reihenfolge

Bild	Symbol	Arbeitsschritt	Reihenfolge:	Anzugsdrehmoment:	Weiterdrehwinkel:	Bemerkungen
1	 1			100 ± 10 Nm		
	 2			23 + 3/0 Nm		
	 3			12 ± 1,2 Nm		
	 4		1, 2	6 ± 0,6 Nm		
	 4		1, 2		70° * 15° / - 5°	
						Einbaulage beachten.
2		1	A, B, C, D	20 ± 2 Nm		
		2	A, B, C, D		90° + 15° / - 5°	

en

Symbols & Signal Words

-  **DANGER** Imminent hazard situation: serious personal injury or death as a result
-  **WARNING** Possible hazard situation: minor or moderate personal injury or material loss as a result
-  **CAUTION** Possible hazard situation: serious personal injury or death as a result
-  Parts having item numbers with circles are included in the kit.







-  Instruction / Information for a correct repair
-  The kit can be used for devices according table.
-  Fasteners must be tightened to a specific torque.
- NOTE** Instruction / Information for a correct repair

General Repair Hints

1. Only qualified personnel of a specialist workshop are authorized to perform repair work on a vehicle's security system.
2. Absolutely follow specifications and instructions of vehicle manufacturer.
3. Keep to company's relevant accident prevention regulations and national regulations.
4. Use only spare parts released by WABCO or vehicle manufacturer.
5. Always start repair work only when you have read and understood all information required for repair. Documents additionally needed: Test Instruction, Spare Parts List, General Repair and Test Hints (815 010 109 3) to be found on www.wabco-auto.com by entering product number of the device or the publication number in INFORM.
6. Check each repaired equipment for functional efficiency and tightness on an adequate facility according to the test instruction.
7. WABCO does not accept any liability or responsibility for the quality or functionality of a repaired device





en



Sequence of assembly

Picture	Symbol	Procedure	Sequence:	Torque:	Rotation angle:	Comments
1	 1			100 ± 10 Nm		
	 2			23 + 3/0 Nm		
	 3			12 ± 1,2 Nm		
	 4		1, 2	6 ± 0,6 Nm		
	 4		1, 2		70° * 15° / - 5°	
	 i					Observe installation position.
2	 T	1	A, B, C, D	20 ± 2 Nm		
		2	A, B, C, D		90° + 15° / - 5°	

es

Símbolos & Palabras de aviso







-  **DANGER** PELIGRO Situación de peligro inminente: Pueden ocasionarse daños personales graves o incluso mortales
-  **WARNING** CUIDADO Posible situación de peligro: Pueden ocasionarse daños personales leves o moderados o pérdidas materiales
-  **CAUTION** ADVERTENCIA Posible situación de peligro: Pueden ocasionarse daños personales graves o incluso mortales
-  Los componentes incluidos en el kit son los números que aparecen con círculo.

-  Instrucciones/Información para una correcta reparación
-  El kit puede ser utilizado en los equipos que aparecen en la tabla.
-  Los cierres deben apretarse con un par de apriete determinado.
- NOTE** Instrucciones/Información para una correcta reparación

Consejos generales de reparación





1. Sólo el personal cualificado de un taller especializado está autorizado para realizar las tareas de reparación en los sistemas de seguridad de los vehículos.
3. Siga las regulaciones y normas acerca de prevención de riesgos laborales de su empresa y de su país.
5. Comience la reparación sólo cuando haya leído y comprendido las instrucciones de reparación. Documentos adicionales necesarios: Instrucciones de comprobación, listas de despiece, consejos generales de comprobación y reparación (815 040 109 3), los cuales pueden encontrarse en www.wabco-auto.com, introduciendo la referencia del aparato o la referencia de la publicación en la aplicación INFORM.
7. WABCO no asume garantía alguna por el funcionamiento o calidad de un equipo reparado.
2. Atenerse exactamente a las indicaciones e instrucciones del fabricante del vehículo.
4. Utilice piezas de repuesto suministradas por WABCO o el fabricante del vehículo.
6. Compruebe la eficacia de funcionamiento y de ajuste de cada equipo reparado en unas instalaciones adecuadas según las instrucciones de comprobación.

Montaje sucesión

Dibujó	Símbolo	Procedimiento	Sequenza di serraggio:	Par de apriete:	Ángulo de rotación:	Observaciones
1	 1			100 ± 10 Nm		
	 2			23 + 3/0 Nm		
	 3			12 ± 1,2 Nm		
	 4		1, 2	6 ± 0,6 Nm		
	 4		1, 2		70° * 15° / - 5°	
	 i					Prestar atención a la posición de instalación.
2	 T	1	A, B, C, D	20 ± 2 Nm		
		2	A, B, C, D		90° + 15° / - 5°	

fr

Symboles & Significations

-  **DANGER** DANGER Situation de danger imminent : Danger de mort ou de dommage corporel sérieux.
-  **WARNING** ATTENTION Situation de danger probable : Risque de dommage corporel mineur ou modéré ou perte de matériel.
-  **CAUTION** AVERTISSEMENT Situation de danger de danger probable : Danger de mort ou de dommages corporel sérieux
-  Les composants avec repères entourés sont inclus dans le kit.

 Instruction/Information pour uneréparation correcte

 Le kit peut être utilisé pour les appareils indiqués sur le Feuillet.







 Les fixations doivent être serrées à un couple spécifique.

NOTE Instruction/Information pour uneréparation correcte

Conseils généraux de réparation





1. Uniquement le personnel qualifié d'un atelier agréé WABCO est autorisé à effectuer la réparation sur les systèmesde sécurité d'un véhicule.
3. Veillez aux règlements de prévention des accidents indiqués par votre société et aux règlements nationaux.
5. Commencez toujours le travail de réparation seulement après avoir lu et compris toutes les informations indiquées pour la réparation. Documentation complémentaire nécessaire : Instruction d'essai, liste des pièces détachées, instructions de réparation et conseils d'essai (815 030 109 3) en tapant la référence du produit ou le numéro de la publication dans INFORM sur internet : www.wabco-auto.com
7. WABCO n'assume aucune garantie quant au fonctionnement ou à la qualité d'un appareil réparé.
2. Respecter toujours les prescriptions et instructions du constructeur du véhicule.
4. Employez seulement les pièces de rechange WABCO ou du constructeur du véhicule.
6. Examinez chaque appareil réparé pour s'assurer de l'efficacité fonctionnelle et de l'étanchéité selon l'instruction d'essai.

Les montages ordre

Image	Symbole	Procédure	Sequence:	Couple de serrage:	Angle de rotation:	Remarques
1	 1			100 ± 10 Nm		
	 2			23 + 3/0 Nm		
	 3			12 ± 1,2 Nm		
	 4		1, 2	6 ± 0,6 Nm		
	 4		1, 2		70° * 15° / - 5°	
						Faire attention à la position de montage.
2		1	A, B, C, D	20 ± 2 Nm		
		2	A, B, C, D		90° + 15° / - 5°	

hr

Simboli & Značenja

-  **DANGER** OPREZ Neposredna rizična situacija: moguće ozbiljno ozljeđivanje ili smrt
-  **WARNING** OPASNOST neposredna rizična situacija: moguće manje ozljeđivanje mterijalna šteta
-  **CAUTION** UPOZORENJE Neposredna rizična situacija: moguće ozbiljno ozljeđivanje ili smrt
-  Dijelovi uređaja čiji su brojevi zaokruženi nalaze se u kompletu..

 Informacija o ispravnom popravku.

 Set može biti korišten za uređaje prema tabeli.

 Spone moraju biti stegnute prema specifičnim silama zatezanja.

NOTE Informacija o ispravnom popravku.

hr

Opće upute o popravcima





1. Samo kvalificirane osobe istručnjaci smiju popravljati siguronosne sustave na vozilu.
2. U potpunosti slijedi specifikacije i upute proizvođača vozila.
3. Provodi tvrtkine siguronosne propise kao i nacionalne propise o sigurnosti
4. Koristi rezervne dijelove proizvedene od WABCA ili proizvođača vozila..
5. Popravak počni tek nakon što pročitaš i shvatiš upute o popravku. Potrebni dokumenti: Instrukcije o testiranju, Lista rezervnih dijelova, Opće natuknice o popravku i testiranju (815 010 109 3) mogu se naći na www.wabco-auto.com nakon upisa kataložskog broja proizvoda ili publikacije u INFORM-u.
6. Provjeri svaki popravljani uređaj kako radi i da li je zategnuto sve kako treba prema odgovarajućim uputama o testiranju proizvoda.
7. WABCO ne preuzima odgovornost za rad i kvalitetu popravljenog uređaja.



Redosljed ugradnje

Slika	Simbol	Postupak	Redosljed:	Zakretni moment:	Kut zakretanja:	Komentar
1	 1			100 ± 10 Nm		
	 2			23 + 3/0 Nm		
	 3			12 ± 1,2 Nm		
	 4		1, 2	6 ± 0,6 Nm		
	 4		1, 2		70° * 15° / - 5°	
	 i					Provjeri položaj ugradnje.
2	 T	1	A, B, C, D	20 ± 2 Nm		
		2	A, B, C, D		90° + 15° / - 5°	

it

Simboli e Segnali

-  **DANGER** PERICOLO Imminente situazione di rischio: serie ferite personali fino anche alle morte
-  **WARNING** PRUDENZA Possibili situazioni di pericolo: possibili lievi ferite o perdita di materiale
-  **CAUTION** AVVERTENZA Possibili situazioni di pericolo: serie ferite personali fino anche alle morte
-  I componenti indicati con un numero cerchiato, sono inclusi nel kit.







-  Istruzioni/Informazioni per unacorretta riparazione
-  Il kit può essere usato per gli articoli secondo la tabella.
-  I fissaggi devono essere stretti ad una coppia di serraggio specifica.
- NOTE** Istruzioni/Informazioni per unacorretta riparazione

Suggerimenti per la riparazione

1. Soltanto il personale qualificato delle officine specializzate è autorizzato ad effettuare le riparazioni sui sistemi di sicurezza dei veicoli.
2. E' assolutamente necessario seguire le istruzioni e le specifiche del costruttore del veicolo.
3. Attenersi alle norme nazionali e aziendali in merito alla prevenzione degli infortuni.
4. Usare solo ricambi originali WABCO o del costruttore del veicolo.
5. Effettuare la riparazione solamente dopo aver letto e capito tutte le informazioni richieste per la riparazione. Ulteriori informazioni necessarie: istruzioni di collaudo, catalogo dei ricambi, cenni generali sulla riparazione e test (815 050 109 3) possono essere trovati sul sito www.wabco-auto.com alla voce INFORM entrando per codice dell'apparecchio o per numero della pubblicazione.
6. Controllare la funzionalità e l'efficienza di ogni apparecchiatura riparata secondo le istruzioni riportate nel manuale di collaudo.
7. WABCO non si assume alcuna responsabilità per il funzionamento o la qualità di un apparecchio riparato.





it

Sequenza di montaggio

Figura	Simbolo	Fase di lavoro	Sequenza:	Coppia di serraggio:	Angolo di rotazione:	Note
1	 1			100 ± 10 Nm		
	 2			23 + 3/0 Nm		
	 3			12 ± 1,2 Nm		
	 4		1, 2	6 ± 0,6 Nm		
	 4		1, 2		70° * 15° / - 5°	
						Osservare la posizione di montaggio.
2		1	A, B, C, D	20 ± 2 Nm		
		2	A, B, C, D		90° + 15° / - 5°	

pl

Hasła ostrzegawcze i symbole

-  **DANGER** NIEBEZPIECZEŃSTWO Bezpośrednie zagrożenie ciężkimi obrażeniami bądź śmiercią.
 -  **WARNING** UWAGA! Niebezpieczeństwo grożące lekkimi bądź średnimi obrażeniami.
 -  **CAUTION** OSTRZEŻENIE Niebezpieczeństwo grożące śmiercią bądź ciężkimi obrażeniami.
-  Części oznaczone kółkiem wokół numeru pozycji należą do zestawu naprawczego.

 Wskazówki / Informacje dotyczące poprawnej naprawy.

 Zestaw naprawczy może być używany do urządzeń według tabeli.







 Dokręcić element podanym momentem obrotowym.

NOTE Wskazówki / Informacje dotyczące poprawnej naprawy.

Ogólne porady naprawcze





1. Prace naprawcze w obrębie urządzeń układu bezpieczeństwa pojazdu mogą być wykonane jedynie przez wykwalifikowany personel specjalistycznego warsztatu.
3. Należy przestrzegać zakładowych i krajowych przepisów BHP.
5. Naprawę należy rozpocząć dopiero wówczas, gdy wszystkie potrzebne do niej informacje zostaną przeczytane i zrozumiane. Dokumenty potrzebne dodatkowo: instrukcja kontrolna, tabela części zamiennych, ogólne wskazówki dotyczące naprawy i kontroli (815 020 109 3) znajdują Państwo na stronie internetowej www.wabco-auto.com, podając numer urządzenia bądź numer publikacji w bazie INFORM.
7. WABCO nie udziela żadnej gwarancji na działanie lub jakość naprawionego urządzenia.
2. Należy koniecznie postępować według wytycznych i wskazówek producenta pojazdu.
4. Należy używać wyłącznie części zamiennych dopuszczonych przez firmę WABCO bądź przez producenta pojazdu.
6. Na odpowiednim urządzeniu należy sprawdzić każde naprawiane urządzenie - zgodnie z instrukcją kontrolną - pod kątem sprawności działania i szczelności.



Kolejność montażu

Obraz	Symbol	Czynność	Kolejność:	Moment dokręcania:	Kąt obrotu:	Komentarz
1	 1			100 ± 10 Nm		
	 2			23 + 3/0 Nm		
	 3			12 ± 1,2 Nm		
	 4		1, 2	6 ± 0,6 Nm		
	 4		1, 2		70° * 15° / - 5°	
						Zwrócić uwagę na położenie montażowe.
2		1	A, B, C, D	20 ± 2 Nm		
		2	A, B, C, D		90° + 15° / - 5°	

ru

Знаки & символы

-  **DANGER** ОПАСНО Прямая угроза аварийной ситуации: влечет за собой смерть или тяжелые повреждения
-  **WARNING** ОСТОРОЖНО Опасная ситуация: последствиями являются легкие повреждения или повреждения средней тяжести, а также материальный ущерб
-  **CAUTION** ПРЕДУПРЕЖДЕНИЕ Опасная ситуация: влечет за собой смерть или тяжелые повреждения
-  Номера частей, обведенные кружком, Вы найдете в ремкомплекте.

-  Указание/информация для проведения надлежащего ремонта
-  Ремкомплект может быть использован для приборов соответственно таблице.
-  Элемент необходимо подтянуть с помощью заданного момента сопротивления.
- NOTE** Указание/информация для проведения надлежащего ремонта





Общие указания по ремонту



1. Провождение ремонта приборов данной системы должно производиться только квалифицированным персоналом в специализированной мастерской.
3. Соблюдайте предписания предприятия по технике безопасности, а также национальные нормы.
5. Проводите ремонт только после того, как вы прочитали и поняли все информации, необходимые для данного процесса. Дополнительные документы: инструкция по тестированию, список запасных частей, общие инструкции по ремонту и проведению испытаний (815 080 109 3) Вы найдете на www.wabco-auto.com. Для этого необходимо задать номер нужного прибора или номер брошюры в INFORM.
7. Компания WABCO не принимает на себя какую-либо ответственность за работу или качество отремонтированных устройств.
2. Следуйте предписаниям и инструкциям изготовителя транспортного средства.
4. Используйте только запчасти, допущенные к использованию компанией Wabco или производителем транспортного средства.
6. Проконтролируйте каждый отремонтированный прибор- согласно инструкции по тестированию- на работоспособность и герметичность с помощью соответствующего оборудования.

Порядок действий при монтаже.







Изображение	Символ	Порядок действия	Последовательность:	Момент сопротивления:	Угол вращения:	Замечания
1	 1			100 ± 10 Nm		
	 2			23 + 3/0 Nm		
	 3			12 ± 1,2 Nm		
	 4		1, 2	6 ± 0,6 Nm		
	 4		1, 2		70° * 15° / - 5°	
						Обратите внимание на местоположение при монтаже.
2		1	A, B, C, D	20 ± 2 Nm		
		2	A, B, C, D		90° + 15° / - 5°	

zh





-  **DANGER** 危险! 直接危险: 导致个人严重伤害或死亡
-  **WARNING** 小心! 可能危险: 导致较小或一般程度人员伤害或物品损失
-  **CAUTION** 警告! 可能危险: 导致个人严重伤害或死亡
-  修包中包含号码带有圆圈的零件。



-  用于正确维修的指导 and 信息。
-  根据表格所示, 修包可以用于相应的总成维修。
-  紧固件必须根据所指定的力矩上紧。
- NOTE** 用于正确维修的指导 and 信息。

1. 仅在专业维修店的有资质的人员被授权执行车辆安全系统的维修工作。
2. 完全遵循车辆制造商的规格和安装指导。
3. 遵循公司的相关事故预防条例和国家法规。
4. 仅使用于由威伯科公司或整车制造商发布的备件产品。
5. 当你已经阅读并已理解维修所需要的所有信息后，才能开始维修工作。此外需要的信息：试验指导，备件清单，通用维修和试验提示（815 010 109 3）可以在www.wabco-auto.com 找到。只需在其上键入产品号码或INFORM中的出版物号码。
6. 根据试验要求在适当的设备上，检测每个维修设备的功效和紧密性。
7. WABCO对经过修理的设备的功能或质量不承担任何责任。

图片	符号	程序	顺序:	扭矩:	旋转角度:	注释
1	 1			100 ± 10 Nm		
	 2			23 + 3/0 Nm		
	 3			12 ± 1,2 Nm		
	 4		1, 2	6 ± 0,6 Nm		
	 4		1, 2		70° * 15° / - 5°	
	 i					观察安装位置。
2	 T	1	A, B, C, D	20 ± 2 Nm		
		2	A, B, C, D		90° + 15° / - 5°	

Προειδοποιητικές λέξεις & Σύμβολα

-  **DANGER** ΚΙΝΔΥΝΟΣ! Άμεσα επαπειλούμενος κίνδυνος: Σοβαρές σωματικές βλάβες ή θάνατος
-  **WARNING** ΠΡΟΣΟΧΗ! Πιθανή επικίνδυνη κατάσταση: Ελαφρές ή μεσαίας έκτασης σωματικές βλάβες ή υλικές βλάβες
-  **CAUTION** ΠΡΟΕΙΔΟΠΟΙΗΣΗ! Πιθανή επικίνδυνη κατάσταση: Θάνατος ή σοβαρές σωματικές βλάβες
-  Εξαρτήματα με έναν κύκλο γύρω από τον αριθμό θέσης περιλαμβάνονται στο κιτ επισκευής.







-  Οδηγίες / πληροφορίες για την ορθή επισκευή
-  Το κιτ επισκευής μπορεί να χρησιμοποιηθεί για συσκευές αναλόγως του πίνακα.
-  Συσφίξτε το στοιχείο με την ενδεικτική ροπή στρέψης.
- NOTE** Οδηγίες / πληροφορίες για την ορθή επισκευή

Γενικές υποδείξεις επισκευής

1. Εργασίες επισκευής σε συσκευές ενός συστήματος ασφαλείας οχημάτων επιτρέπονται μόνο από εκπαιδευμένο εξειδικευμένο προσωπικό ειδικού συνεργείου.
2. Τηρείτε οπωσδήποτε τις οδηγίες και τις επισημάνσεις του κατασκευαστή του οχήματος.
3. Τηρείτε τους κανονισμούς πρόληψης ατυχημάτων της επιχείρησης, καθώς και τις εθνικές διατάξεις.
4. Χρησιμοποιείτε αποκλειστικά ανταλλακτικά της WABCO ή του κατασκευαστή του οχήματος.
5. Ξεκινάτε την επισκευή μόνο αφού έχετε αναγνώσει και κατανοήσει όλες τις πληροφορίες που είναι απαραίτητες για την επισκευή. Επιπροσθέτως απαιτούμενα έγγραφα: Οδηγίες ελέγχου, Φύλλο ανταλλακτικών, Γενικές υποδείξεις επισκευής και ελέγχου (815 200 109 3), θα τα βρείτε στη σελίδα www.wabco-auto.com, εισάγοντας τον κωδικό προϊόντος της συσκευής και/ή τον αριθμό του εντύπου στον κατάλογο προϊόντων INFORM.
6. Ελέγχετε τη λειτουργικότητα και στεγανότητα κάθε επισκευασμένης συσκευής - σύμφωνα με τις οδηγίες ελέγχου - σε μια κατάλληλη διάταξη.
7. Η WABCO δεν φέρει καμία ευθύνη για τη λειτουργία ή την ποιότητα μιας επισκευασμένης συσκευής.





el

Ακολουθία τοποθέτησης

Εικόνα	Σύμβολο	Βήμα εργασίας	Ακολουθία (σειρά):	Ροπή σύσφιξης:	Γωνία περιστροφής συνέχισης:	Παρατηρήσεις
1	 1			100 ± 10 Nm		
	 2			23 + 3/0 Nm		
	 3			12 ± 1,2 Nm		
	 4		1, 2	6 ± 0,6 Nm		
	 4		1, 2		70° * 15° / - 5°	
	 i					Προσοχή στη θέση τοποθέτησης.
2	 T	1	A, B, C, D	20 ± 2 Nm		
		2	A, B, C, D		90° + 15° / - 5°	

tr

Semboller&belirti sözlere

-  **DANGER** TEHLİKE Tehlikeli durum: ciddi personel yaralanması veya ölüm riski.
-  **WARNING** DİKKAT Tehlike riski: hafif personel yaralanması veya maddi zarar.
-  **CAUTION** UYARI Ciddi personel yaralanması veya ölüm riski.
-  Yuvarlak içinde numarası belirtilen parça numaraları kit içerisinde bulunur.

 Talimat/ Doğru tamir için bilgi

 Tabloda belirtilen parçalar için kit kullanılabilir.







 Vidalar özel tork değerine kadar sıkılmalıdır.

NOTE Talimat/ Doğru tamir için bilgi

Genel tamir bilgisi





- Araçların güvenlik sistemlerinde tamir işlemlerini yalnızca eğitim almış konusunda uzman personeller gerçekleştirebilir.
- Şirket emniyet kuralları ve ulusal regülasyonlarına uyunuz.
- Tamire, tamir işlemi için gerekli olan tüm bilgileri okuyup anladıktan sonra başlayınız. Ayrıca gerekli olan dokümanlar: Test talimatı, yedek parça sayfası, genel tamir ve test bilgileri (815 140 109 3). Tümünü linki altında, online ürün kataloğu INFORM'da cihaza ait ürün numarasını veya baskı numarasını girerek bulabilirsiniz.
- WABCO tamir edilmiş bir cihazın işlevselliği veya kalitesi için hiçbir sorumluluk üstlenmemektedir.
- Araç üretici firma özellikler ve talimatlarına kesinlikle uyunuz.
- Sadece WABCO veya üretici firma tarafından yayınlanan yedek parçaları kullanın.
- Tamir edilmiş her cihazı - test talimatına uygun şekilde - uygun bir donanımla işlevsellik ve sızdırmazlık konusunda kontrol edin.

Montaj sırası

Resim	Sembol	Prosedür	Sıra:	Tork:	Dönüş açısı:	Yorumlar
1	 1			100 ± 10 Nm		
	 2			23 + 3/0 Nm		
	 3			12 ± 1,2 Nm		
	 4		1, 2	6 ± 0,6 Nm		
	 4		1, 2		70° * 15° / - 5°	
	 i					Montaj konumuna dikkat.
2	 T	1	A, B, C, D	20 ± 2 Nm		
		2	A, B, C, D		90° + 15° / - 5°	

pt

Símbolos e Significados

-  **DANGER** Perigo! Risco de acidente iminente: lesão corporal grave e/ou risco de morte.
-  **WARNING** Cuidado! Possível situação de acidente: ferimentos leves/moderados e/ou danos materiais.
-  **CAUTION** Atenção! Possível situação de acidente: lesão corporal grave e/ou risco de morte.
-  Componentes que estão marcados com um círculo compõem o jogo de reparo.

 Instrução/Informação para uma correta reparação.

 O jogo de reparo pode ser utilizado nos produtos relacionados na tabela.







 Parafusos/porcas devem ser montados de acordo com o torque especificado.

NOTE Instrução/Informação para uma correta reparação.

Dicas Gerais para Reparação





1. Por motivo de segurança, somente pessoas qualificadas devem efetuar reparação nos sistemas de freio do veículo.
3. Mantenha e siga as orientações de prevenção de acidentes vigentes e/ou impostas pelos órgãos competentes.
5. Somente inicie o trabalho de reparação após ler e entender todas as informações necessárias para realizar uma reparação. Documentos adicionais necessários: instrução de teste, lista de peças sobressalentes, dicas gerais de testes e reparação (815 130 109 3) podem ser encontrados no site www.wabco-auto.com ao inserir o número do produto.
7. A WABCO não assume qualquer responsabilidade pela função ou qualidade de um equipamento reparado.
2. Siga sempre as recomendações/especificações do fabricante do veículo.
4. Use somente peças de reposição aprovadas pela WABCO ou pelo fabricante do veículo.
6. Verificar cada produto reparado conforme instruções de teste, utilizando os equipamentos necessários e local adequado.

Sequência de montagem

Figura	Símbolo	Procedimento	Sequência:	Torque:	Ângulo de rotação:	Comentários
1	 1			100 ± 10 Nm		
	 2			23 + 3/0 Nm		
	 3			12 ± 1,2 Nm		
	 4		1, 2	6 ± 0,6 Nm		
	 4		1, 2		70° * 15° / - 5°	
						Observar a posição de montagem
2		1	A, B, C, D	20 ± 2 Nm		
		2	A, B, C, D		90° + 15° / - 5°	

ro

Simboluri și cuvinte pentru avertizare

-  **DANGER** Situație de pericol iminentă: poate rezulta vătămare corporală gravă sau deces.
-  **WARNING** Posibilă situație de pericol: pot rezulta vătămări corporale minore sau medii sau pagube materiale
-  **CAUTION** Posibilă situație de pericol: poate rezulta vătămare corporală gravă sau deces
-  Piesele cu numărul de articol încercuit sunt incluse în kit.

 Instrucțiuni / Informare pentru o reparare corectă

 Kitul poate fi folosit pentru dispozitive, conform tabelului.







 Elementele de fixare trebuie să fie strânse la un moment specific.

NOTE Instrucțiuni / Informare pentru o reparare corectă

Instrucțiuni generale referitoare la reparație

1. Numai personalul calificat al unui atelier de service specializat este autorizat să efectueze lucrări de reparații pe sistemul de siguranță al vehiculului.
2. Respectați obligatoriu instrucțiunile date de producătorul vehiculului.
3. Respectați prevederile firmei și cele naționale pentru prevenirea accidentelor.
4. Utilizați exclusiv piese de schimb autorizate de WABCO sau de producătorul autovehiculului.
5. Întotdeauna începeți lucrările de reparații numai după ce ați citit și înțeles toate informațiile necesare pentru reparație. Documente suplimentare necesare: Instrucțiuni de testare, Lista pieselor de schimb, Instrucțiuni generale pentru reparare și testare (815 110 109 3) pot fi găsite pe www.wabco-auto.com introducând codul dispozitivului în INFORM.
6. Verifică eficiența funcțională și etanșeitatea fiecărui echipament reparat pe o instalație adecvată în conformitate cu instrucțiunile de testare.
7. WABCO nu garantează sau nu răspunde pentru funcționarea și calitatea unui dispozitiv reparat.

Secvența asamblării

Imagine	Simbol	Procedură	Secvență:	Moment de torsiune:	Unghi de rotire:	Comentarii
1	 1			100 ± 10 Nm		
	 2			23 + 3/0 Nm		
	 3			12 ± 1,2 Nm		
	 4		1, 2	6 ± 0,6 Nm		
	 4		1, 2		70° * 15° / - 5°	
						Observați poziția de instalare.
2		1	A, B, C, D	20 ± 2 Nm		
		2	A, B, C, D		90° + 15° / - 5°	